



視覺密碼 Visual Cryptography

陳琨

kchen@csie.org

密碼學 Cryptography

- 源於希臘文 “kryptós” 「隱藏」，和 “gráphein” 「寫字」組成，表示隱藏的字

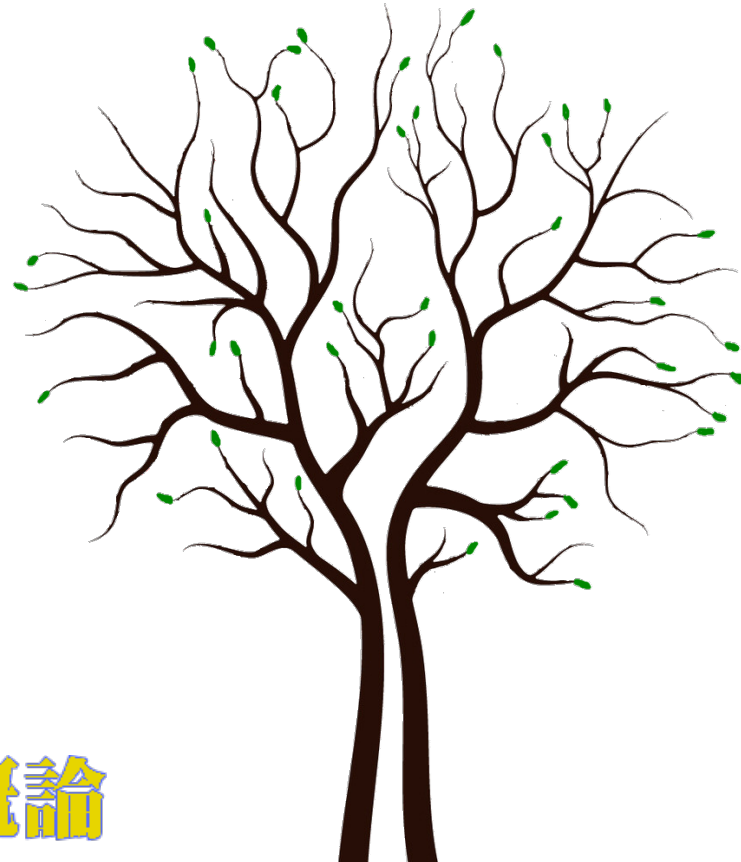

凱撒(Caesar)密碼

- 於西元前50年羅馬皇帝 Julius Caesar 使用
- 將每個字母用其後的第三個字母來取代。

– 明文 : i love you

– 密文 : l oryh brx

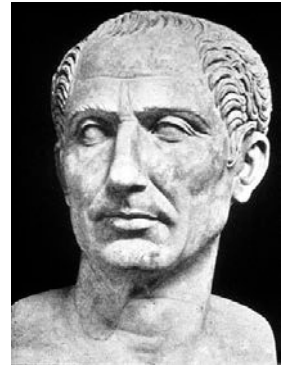
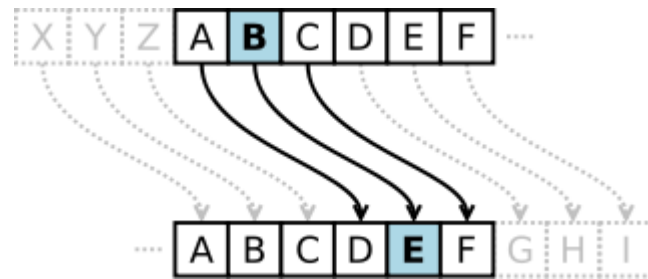

$$C = E_n(P) = (P + n) \bmod 26$$

$$P = D_n(C) = (C - n) \bmod 26$$



福爾摩斯與跳舞的人

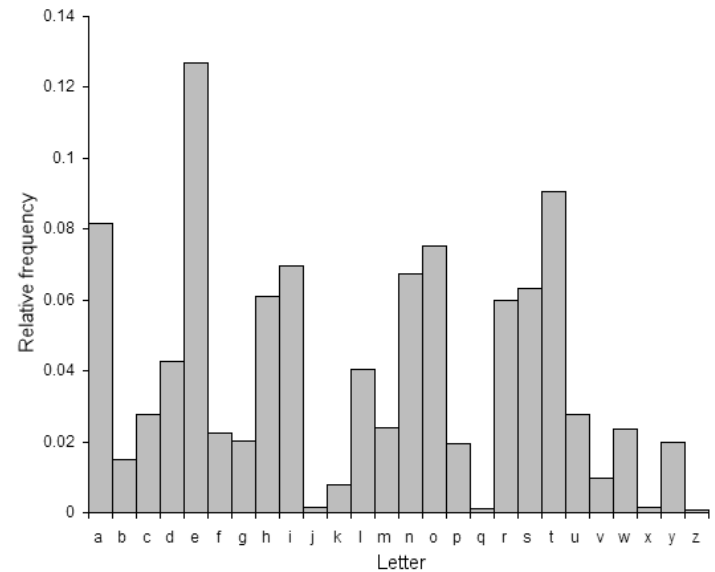

福爾摩斯與跳舞的人

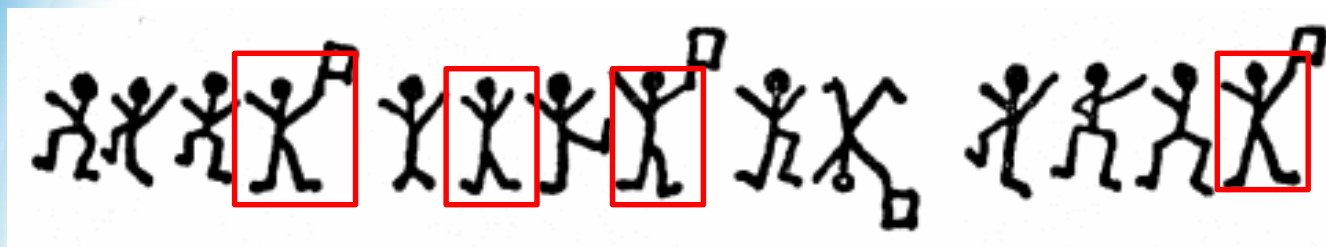

C O M E H E R E A T O N C E

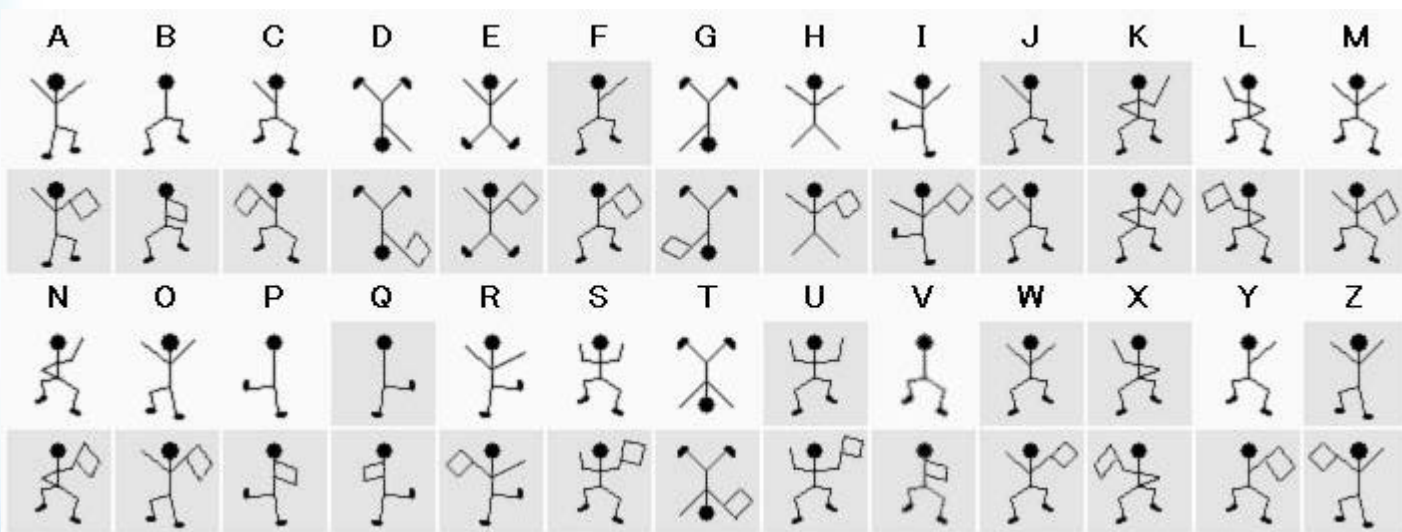

資料加密標準 (DES)

- DES : Data Encryption Standard

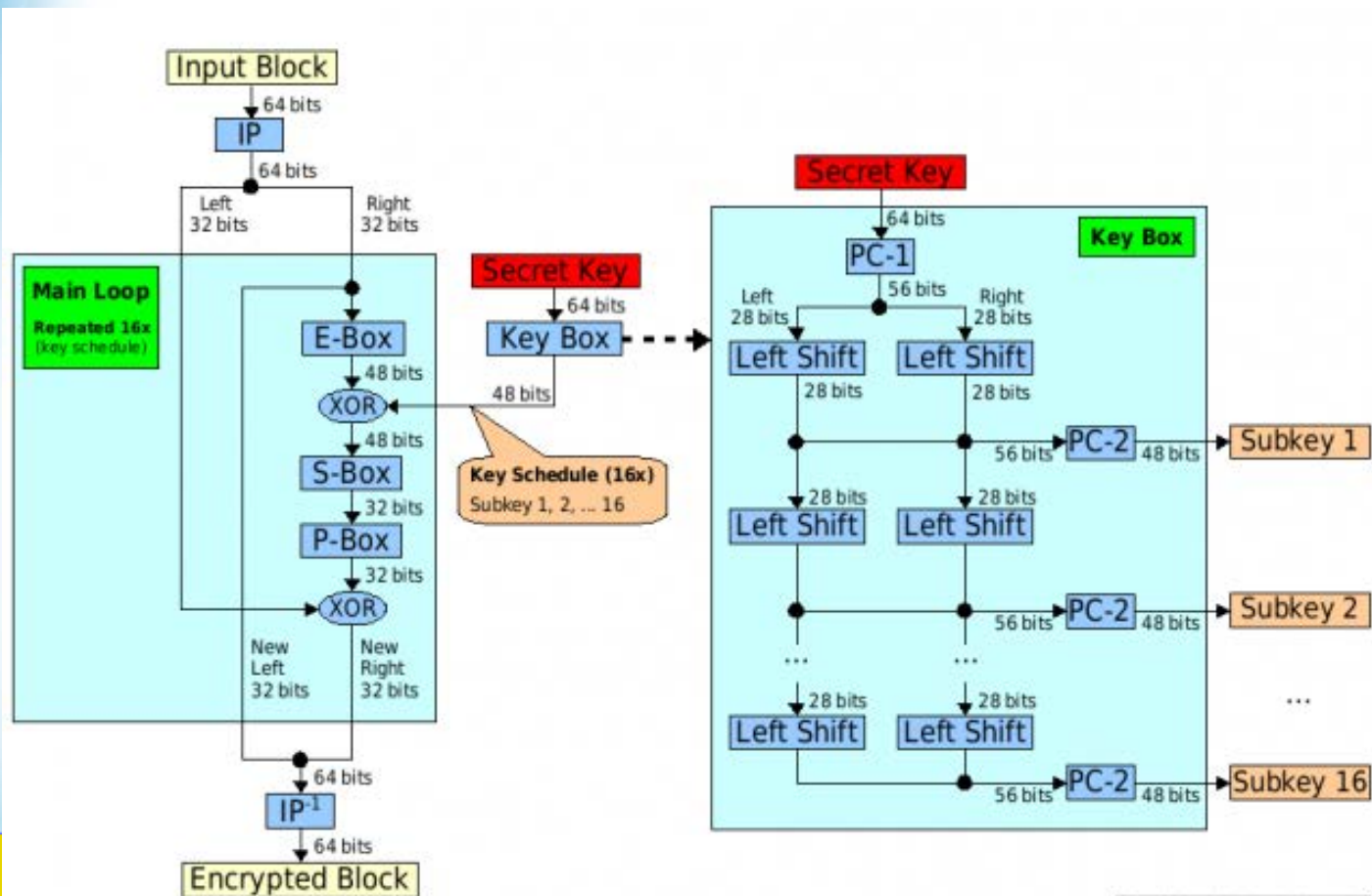

現今密碼應用



One-time pad

- 稱**一次性密碼本**，是一種加密的演算法
- 特性：金鑰是**隨機產生且只用一次**
- 夏農 (Shannon)於1948年證明此種加密是俱有完美的安全性(perfect security)，亦即猜金鑰的機率和猜明文的機率是一樣。

明文：01101001 01110110
金鑰：01100101 01111000
密文：00001100 00001110

XOR

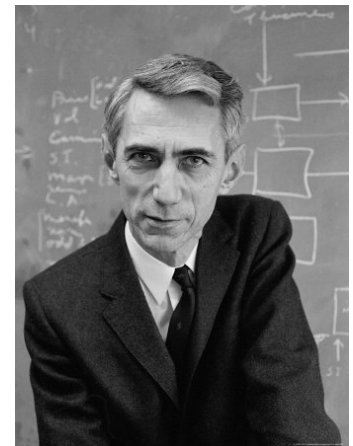
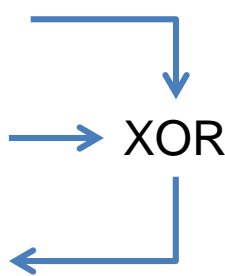

1916-2001



XOR 的秘密

XOR	0	1
0	0	1
1	1	0

OR	0	1
0	0	1
1	1	1

AND	0	1
0	0	0
1	0	1



用OR模擬XOR

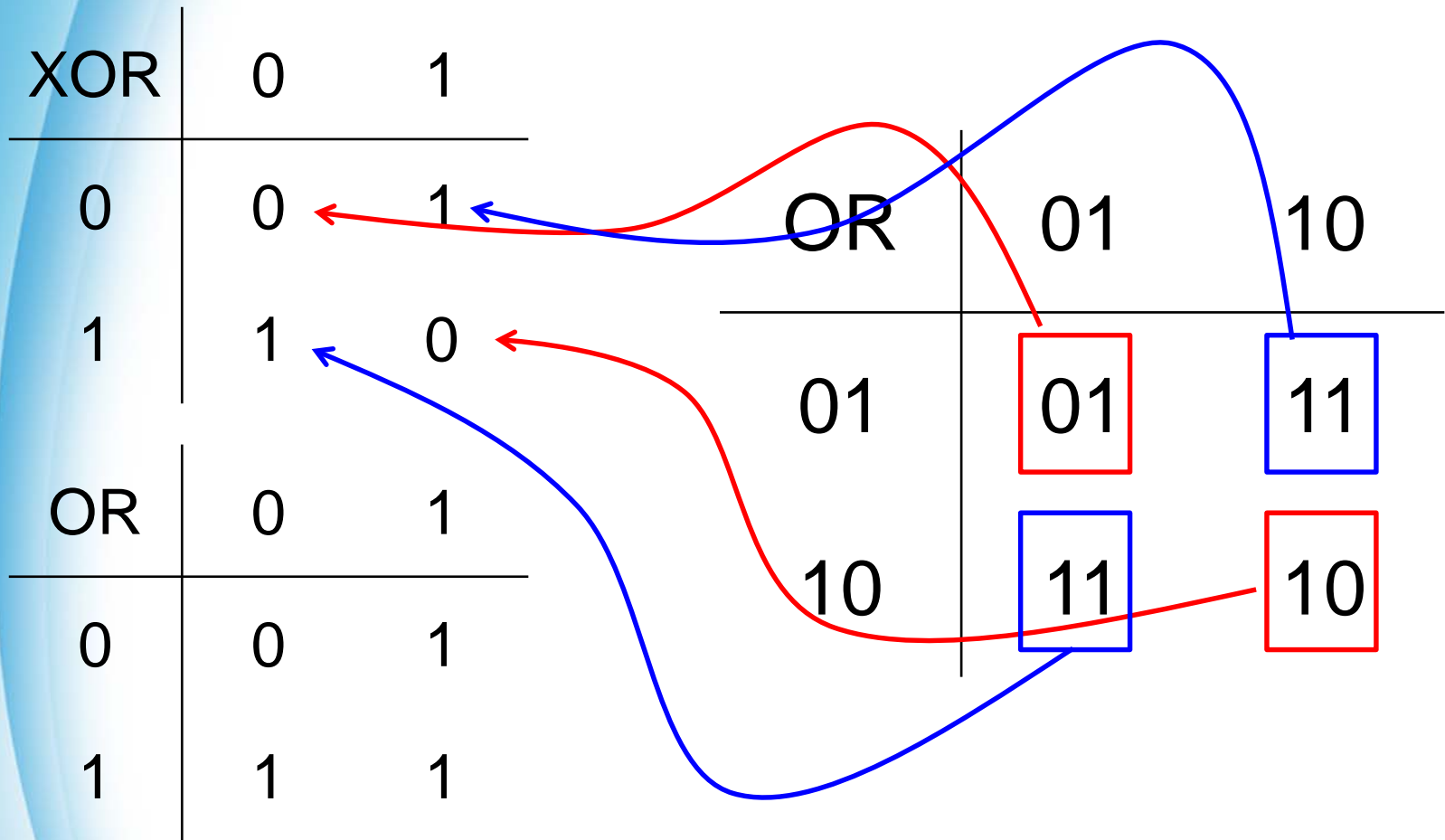

視覺密碼

- 1995年由 Naor 和 Shamir 所提出
- 不同於傳統的密碼學，在於解密時不需要任何的計算，直接利用人的眼睛即可看的出機密

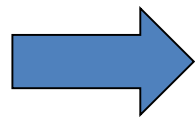

解密

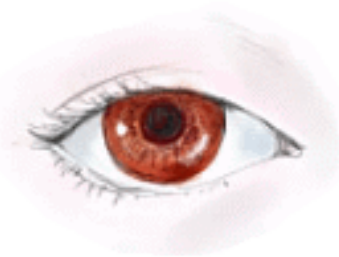



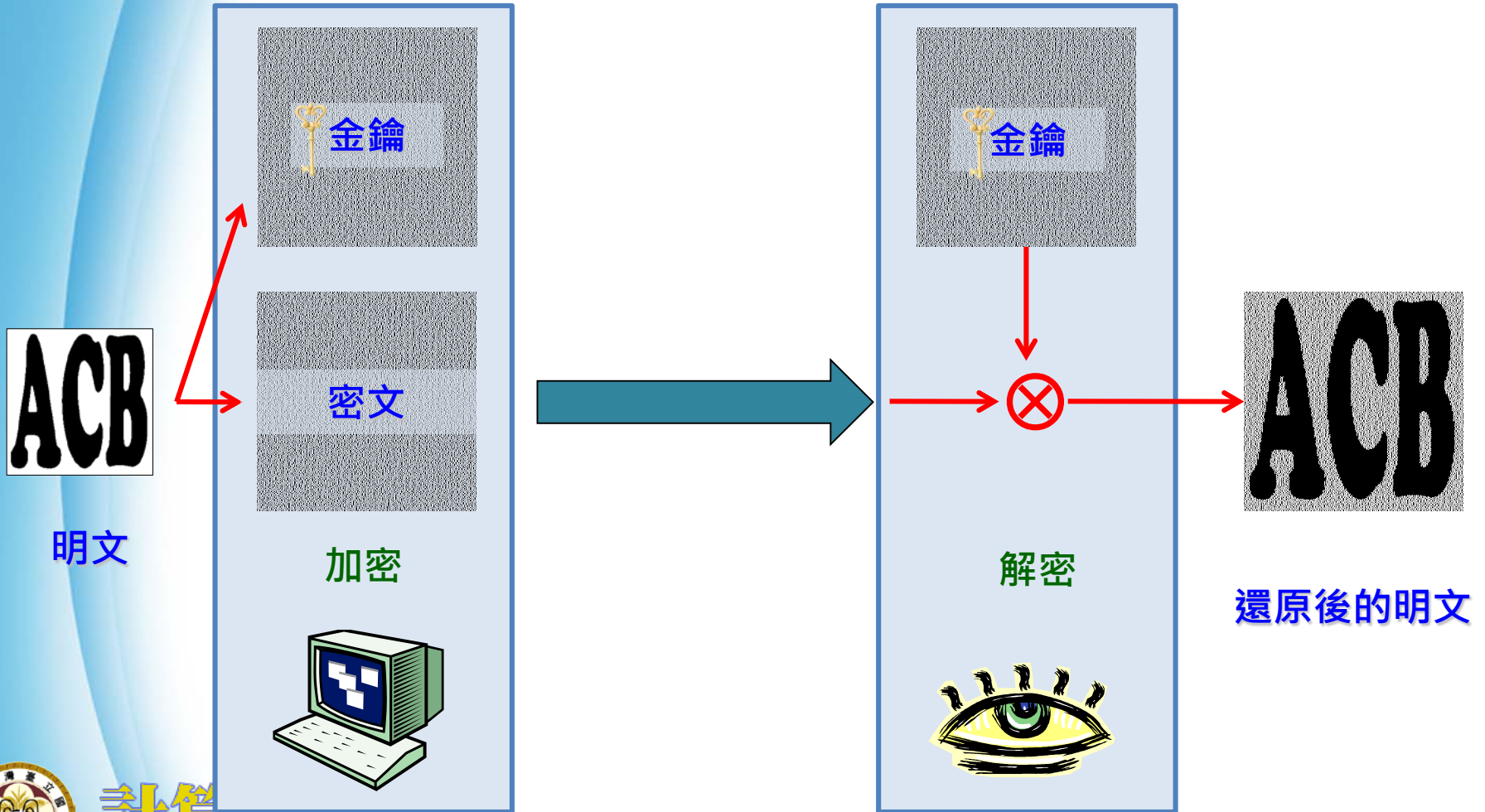





視覺密碼的流程











投影片的效果

OR	0	1
0	0	1
1	1	1

疊合		
		
		

模擬	01	10
01	01	11
10	11	10

疊合		
		
		



視覺密碼的例子

p	s_1	s_2	s_1+s_2
□			
■			

codebook

機密影像

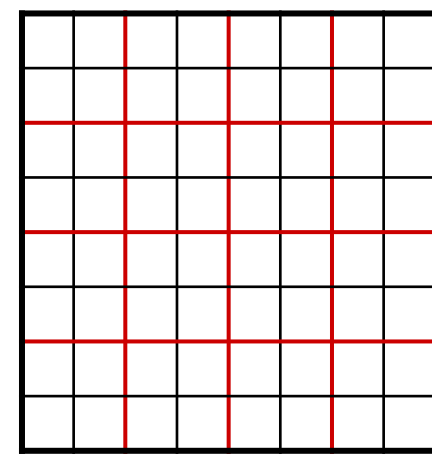
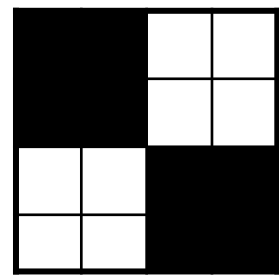

S_1

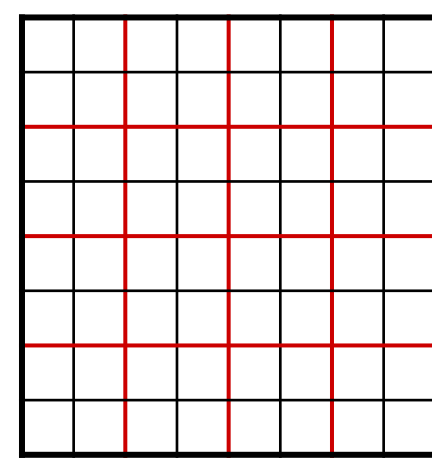

S_2



視覺密碼的例子

p	s_1	s_2	s_1+s_2
□			
■			

codebook

機密影像

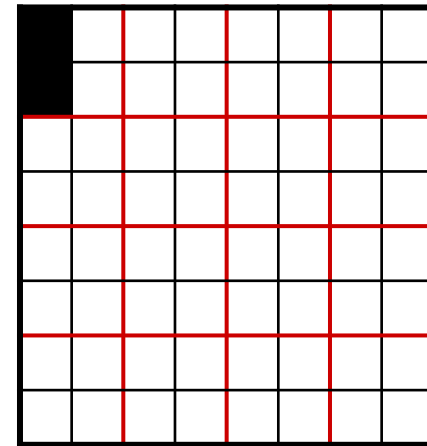
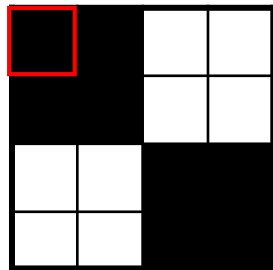



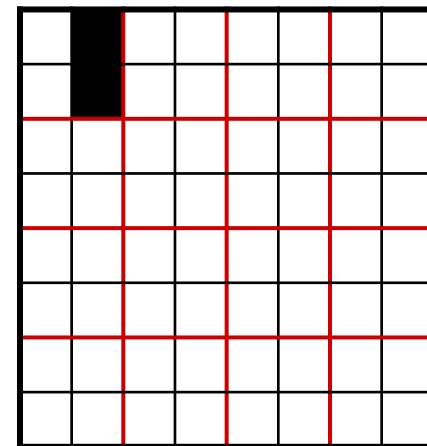













S_1



S_2



視覺密碼的例子

p	s_1	s_2	s_1+s_2
			
			
			
			
			

codebook

機密影像

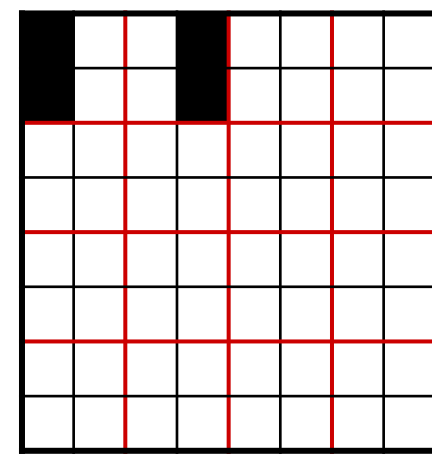
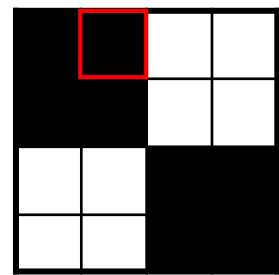



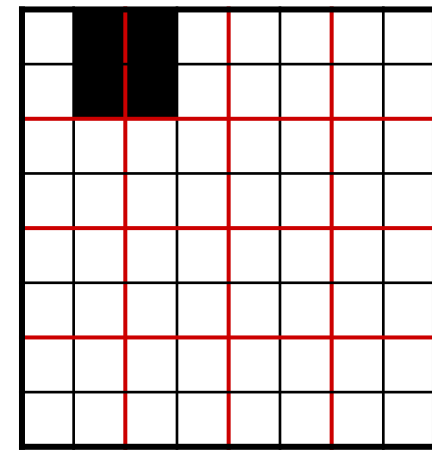













S_1



S_2



視覺密碼的例子

p	s_1	s_2	s_1+s_2
			
			
			
			
			

codebook

機密影像

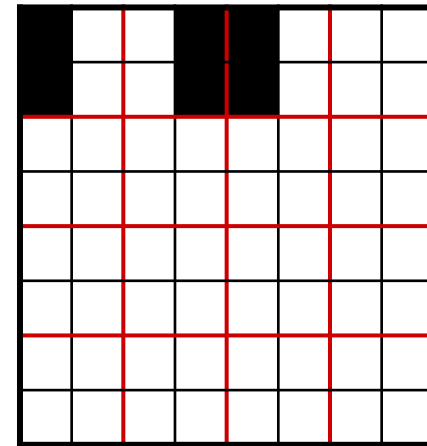
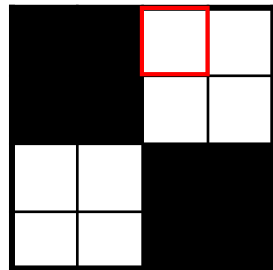



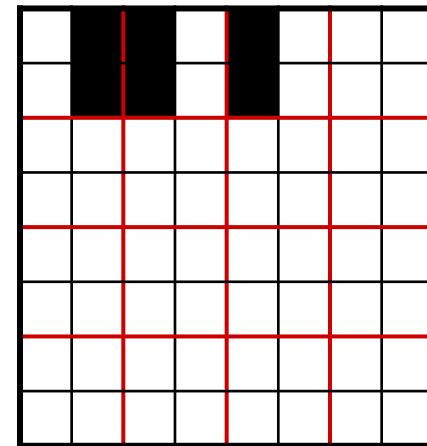











S_1



S_2



視覺密碼的例子

p	s_1	s_2	s_1+s_2
			
			
			
			

codebook

機密影像

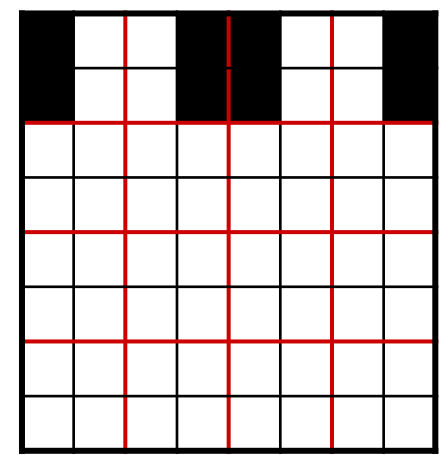
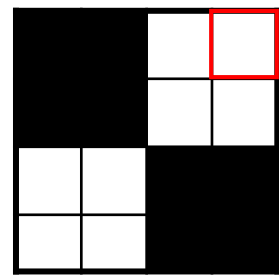



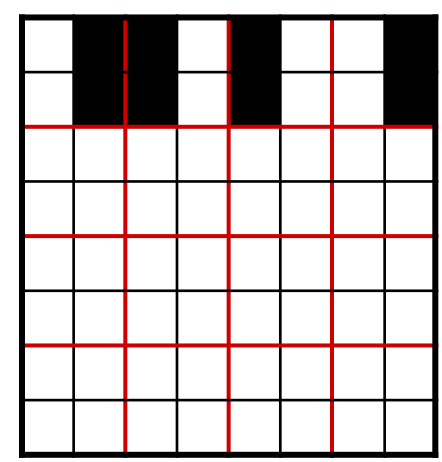













S_1



S_2



視覺密碼的例子

p	s_1	s_2	s_1+s_2
			
			
			
			
			

codebook

機密影像

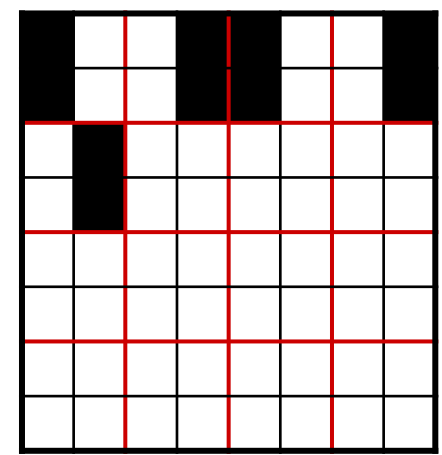
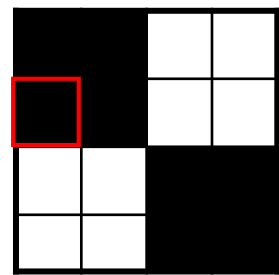

S_1

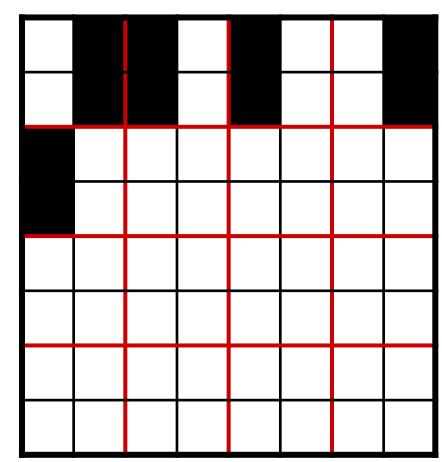

S_2



視覺密碼的例子

p	s_1	s_2	s_1+s_2
□			
■			

codebook

機密影像

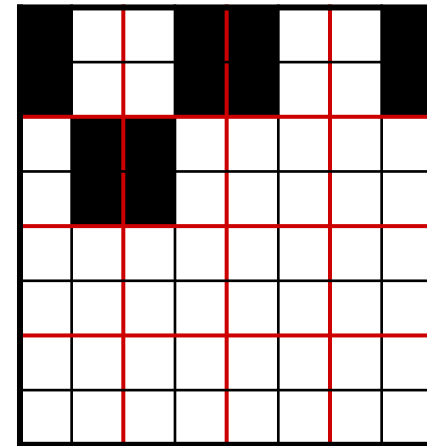
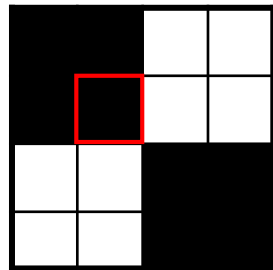



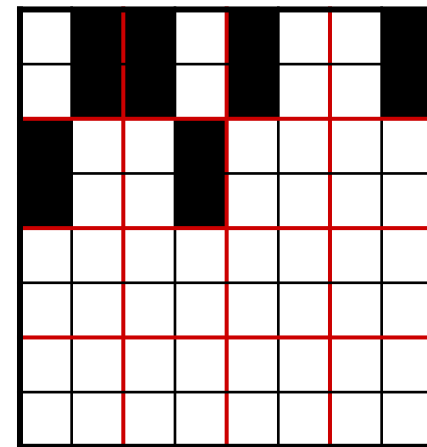











S_1



S_2



視覺密碼的例子

p	s_1	s_2	s_1+s_2
			
			
			
			

codebook

機密影像

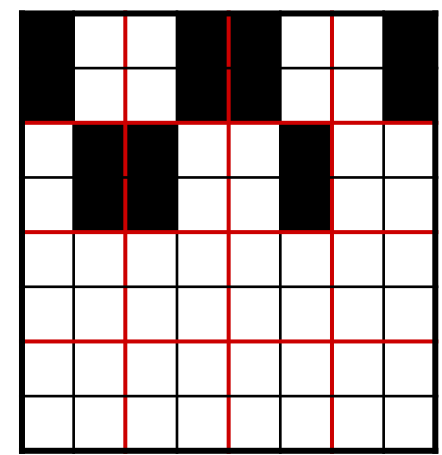
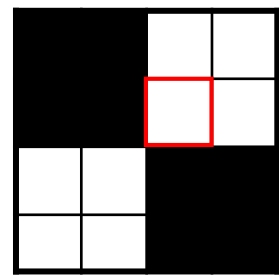



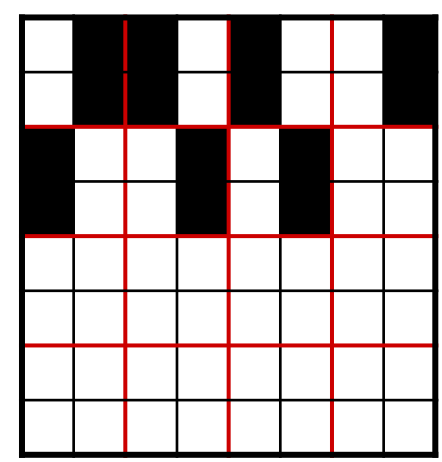







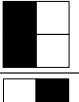

S_1



S_2



視覺密碼的例子

p	s_1	s_2	s_1+s_2
			
			
			
			

codebook

機密影像

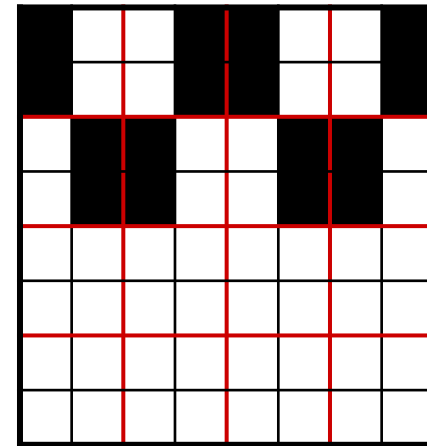
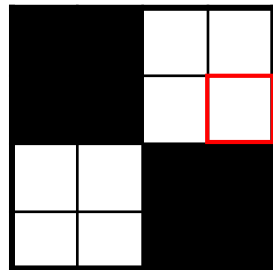



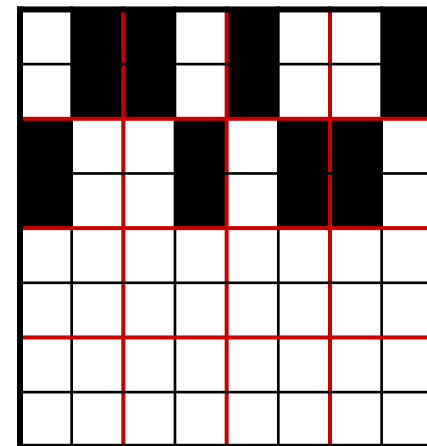











S_1



S_2



視覺密碼的例子

p	s_1	s_2	s_1+s_2
			
			
			
			

codebook

機密影像

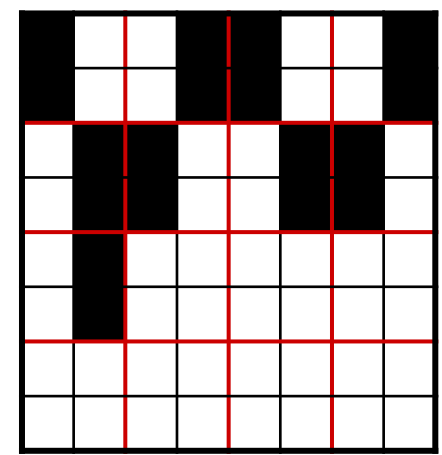
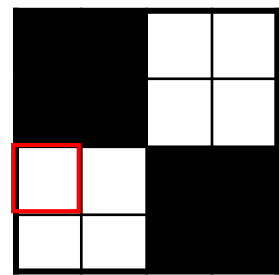



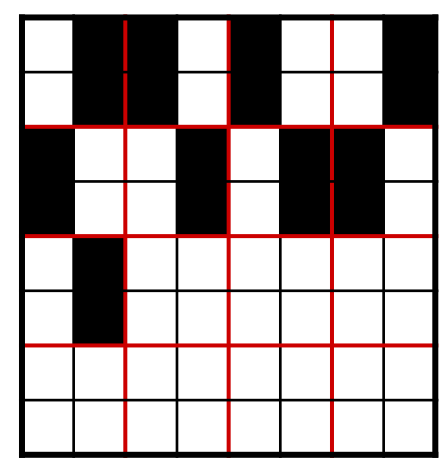











S_1



S_2



視覺密碼的例子

p	s_1	s_2	s_1+s_2
			
			
			
			

codebook

機密影像

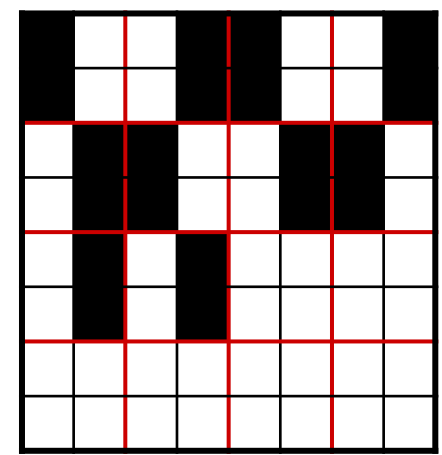
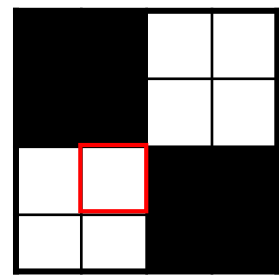

S_1

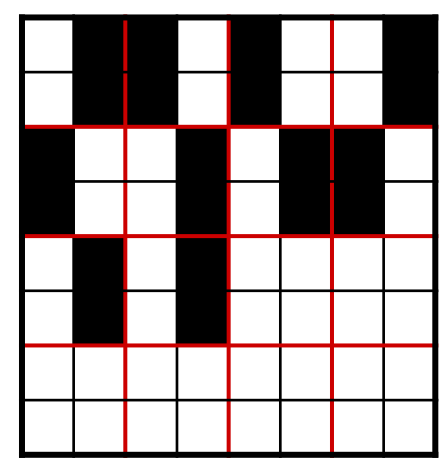

S_2



視覺密碼的例子

p	s_1	s_2	s_1+s_2
□			
■			

codebook

機密影像

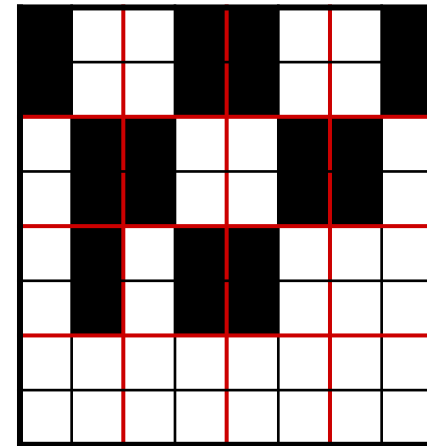
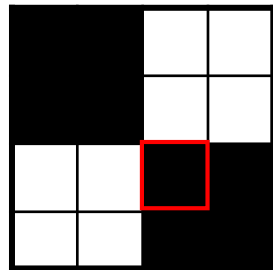

S_1

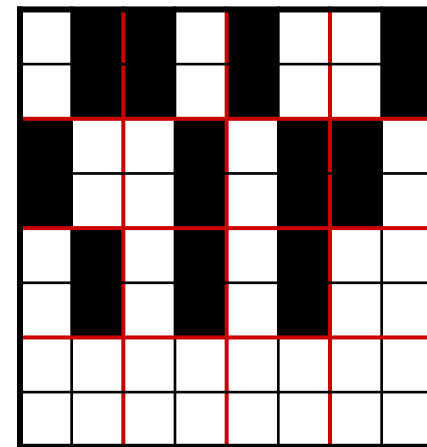

S_2



視覺密碼的例子

p	s_1	s_2	s_1+s_2
□			
■			

codebook

機密影像

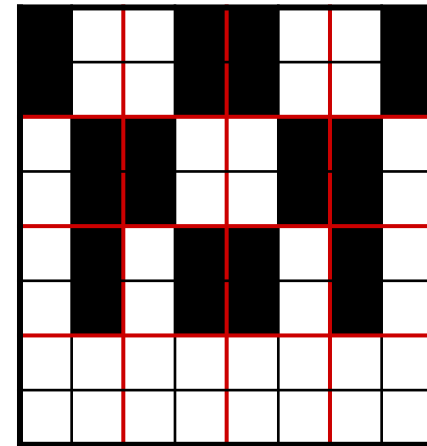
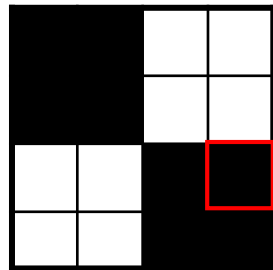



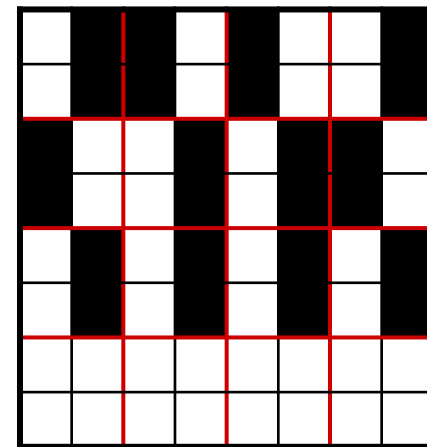







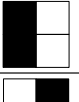

S_1

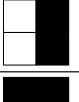

S_2



視覺密碼的例子

p	s_1	s_2	s_1+s_2
			
			
			
			

codebook

機密影像

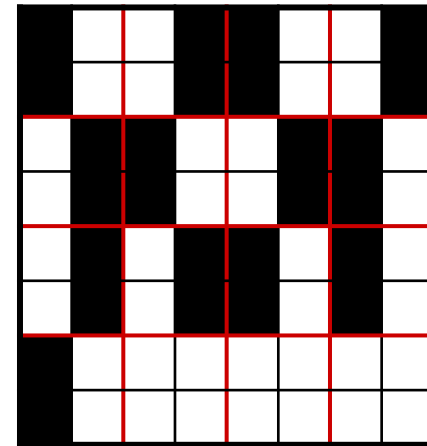
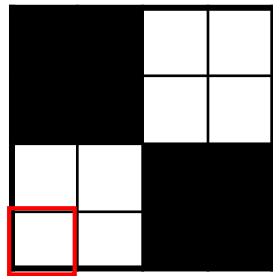



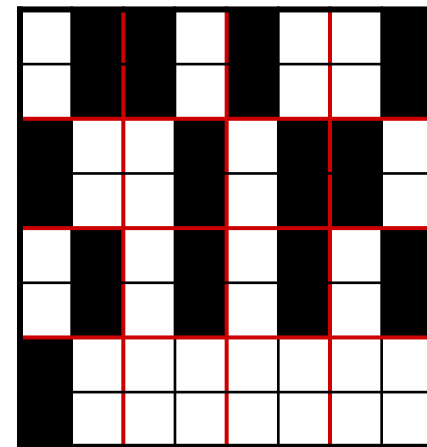











S_1



S_2



視覺密碼的例子

p	s_1	s_2	s_1+s_2
			
			
			
			

codebook

機密影像

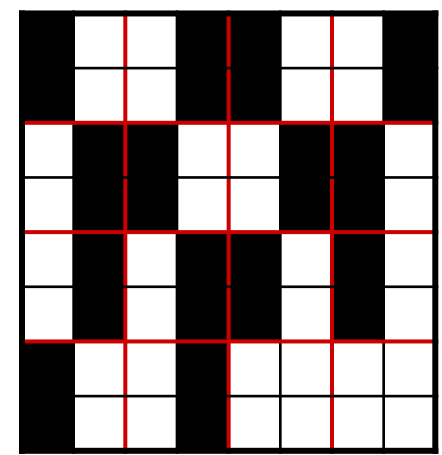
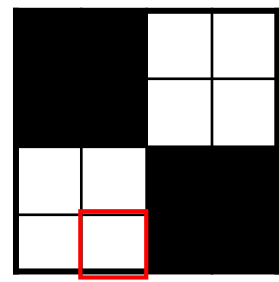



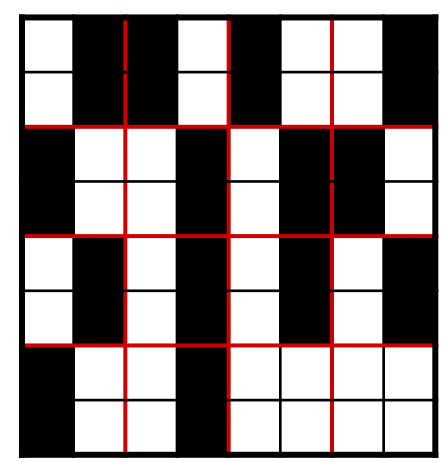











S_1



S_2



視覺密碼的例子

p	s_1	s_2	s_1+s_2
			
			
			
			

codebook

機密影像

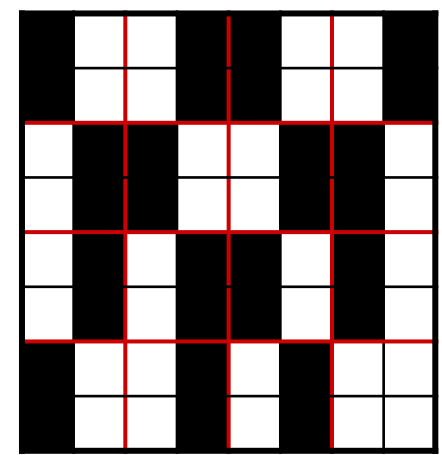
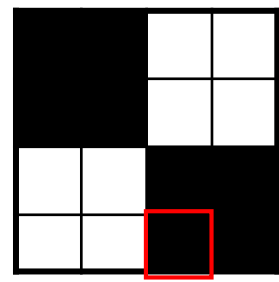

S_1

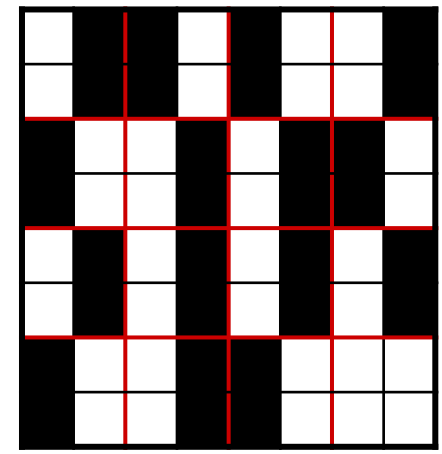

S_2



視覺密碼的例子

p	s_1	s_2	s_1+s_2
□			
■			

codebook

機密影像

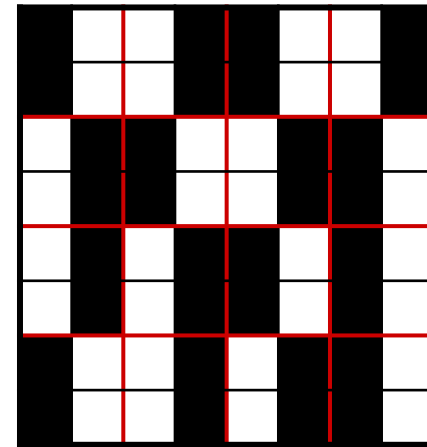
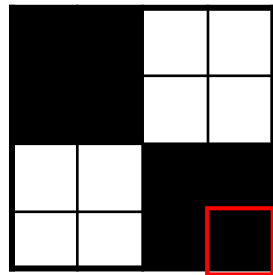

S_1

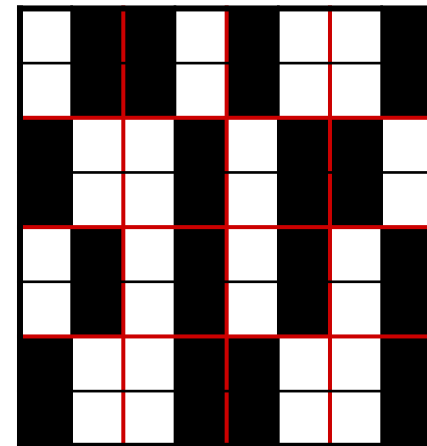

S_2



視覺密碼的例子

p	s_1	s_2	s_1+s_2
□			
■			

codebook

機密影像

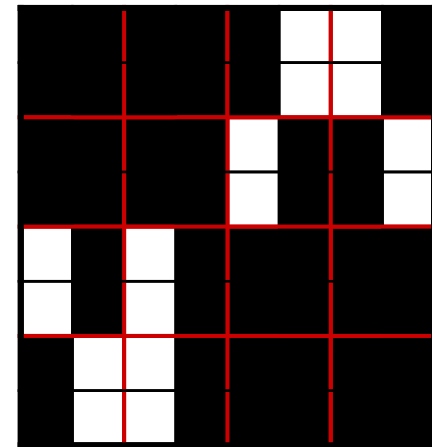
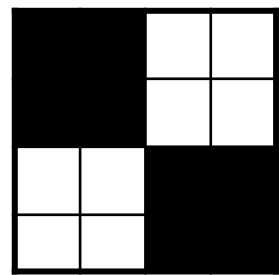

S_1

S_2



視覺機密分享

- $(2, 2)$ 視覺機密分享機制
- (n, n) 視覺機密分享機制
- (k, n) 視覺機密分享機制
- GAS(General Access Structure)視覺機密分享機制



視覺機密分享

- (2, 2) 視覺機密分享機制
- (n, n) 視覺機密分享機制
- (k, n) 視覺機密分享機制
- GAS (Group Access Structure) 視覺機密分享機制

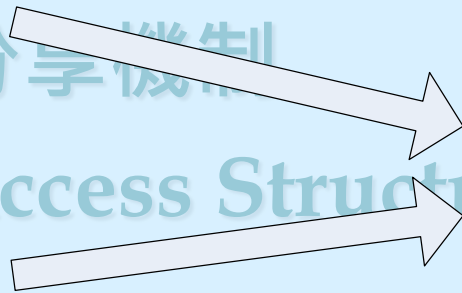
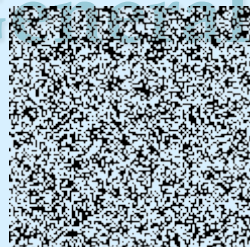
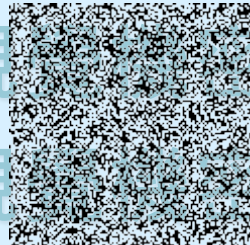

視覺機密分享

- (2, 2) 視覺機密分享機制
- (n, n) 視覺機密分享機制
- (k, n) 視覺機密分享機制
- GAS (General Access Structure) 視覺機密分享機制

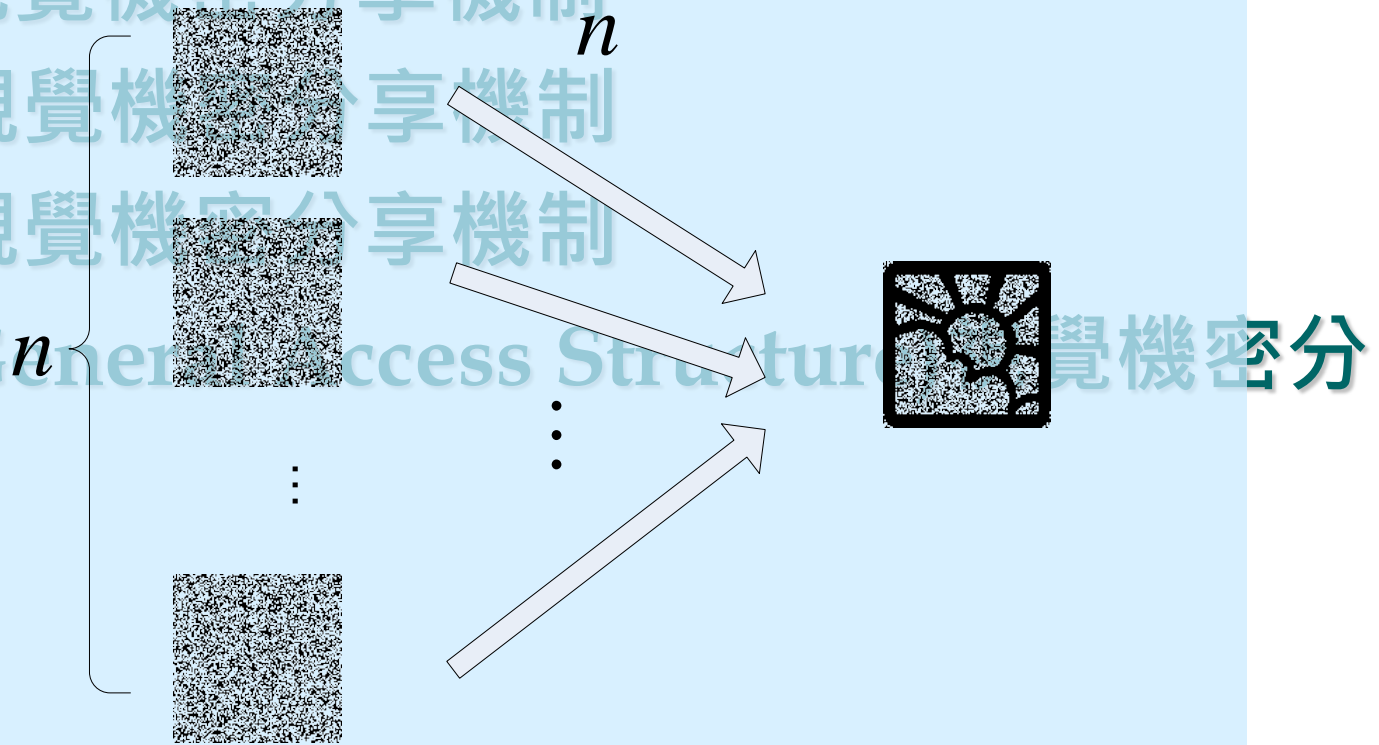

視覺機密分享

- (2, 2) 視覺機密分享機制
- (n, n) 視覺機密分享機制
- (k, n) 視覺機密分享機制
- GAS (General Access Structure) 視覺機密分享機制

n

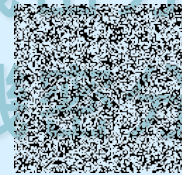

k

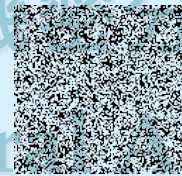

⋮

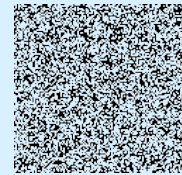

⋮

$k \leq n$



視覺機密分

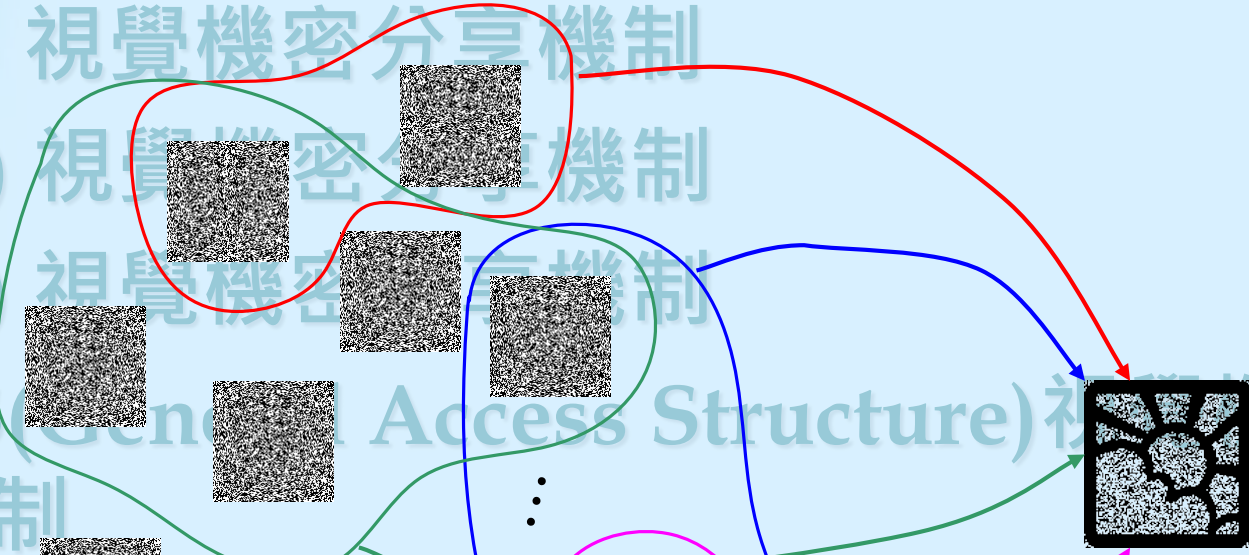

視覺機密分享

- $(2, 2)$ 視覺機密分享機制
 - (n, n) 視覺機密分享機制
 - (k, n) 視覺機密分享機制
 - GAS (General Access Structure) 視覺機密分享機制
- 
- The diagram illustrates the visual secret sharing process. On the left, there is a grid of small square shares. On the right, there is a larger square representing the reconstructed image. Colored arrows (red, blue, green, magenta) connect specific shares to the reconstructed image, representing different access structures: $(2, 2)$, (n, n) , (k, n) , and GAS (General Access Structure).





機密影像

$$S_0 \in C_0 \begin{bmatrix} 0 & 1 & 1 & 0 \\ 0 & 1 & 0 & 1 \\ 0 & 0 & 1 & 1 \\ 1 & 0 & 0 & 1 \end{bmatrix}$$

$$S_1 \in C_1 \begin{bmatrix} 0 & 1 & 0 & 1 \\ 0 & 1 & 0 & 1 \\ 0 & 0 & 1 & 1 \end{bmatrix}$$







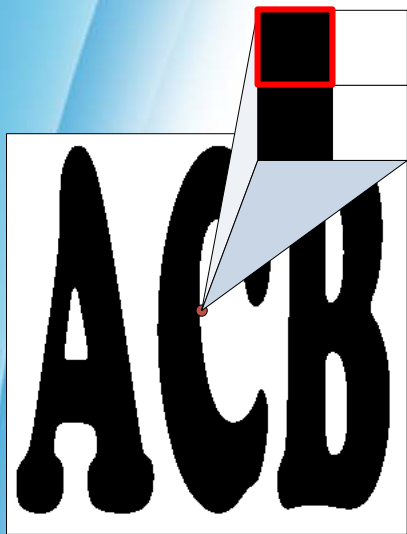

機密影像

$$S_0 \in C_0 \begin{bmatrix} 0 & 1 & 1 & 0 \\ 0 & 1 & 0 & 1 \\ 0 & 0 & 1 & 1 \\ 1 & 0 & 0 & 1 \end{bmatrix}$$

$$S_1 \in C_1 \begin{bmatrix} 0 & 1 & 0 & 1 \\ 0 & 1 & 0 & 1 \\ 0 & 0 & 1 & 1 \end{bmatrix}$$







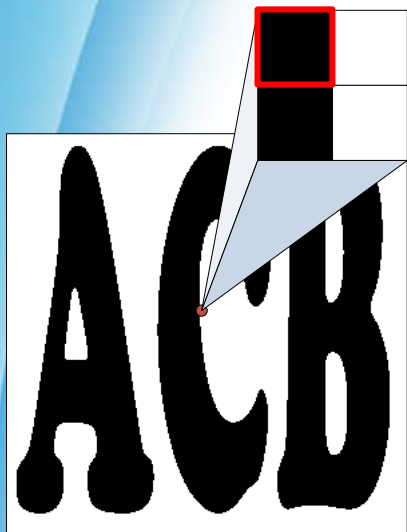

機密影像

$$S_0 \in C_0 \begin{bmatrix} 0 & 1 & 1 & 0 \\ 0 & 1 & 0 & 1 \\ 0 & 0 & 1 & 1 \end{bmatrix}$$

$$S_1 \in C_1 \begin{bmatrix} 1 & 0 & 1 & 0 \\ 1 & 1 & 0 & 0 \\ 1 & 0 & 0 & 1 \end{bmatrix}$$







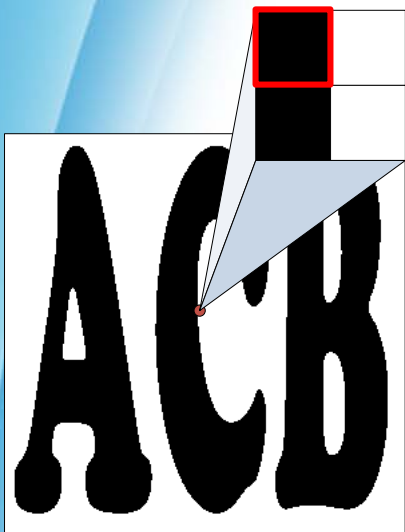

機密影像

$S_0 \in C_0$

0	1	1	0
0	1	0	1
0	0	1	1

$S_1 \in C_1$

1	0	1	0
1	1	0	0
1	0	0	1

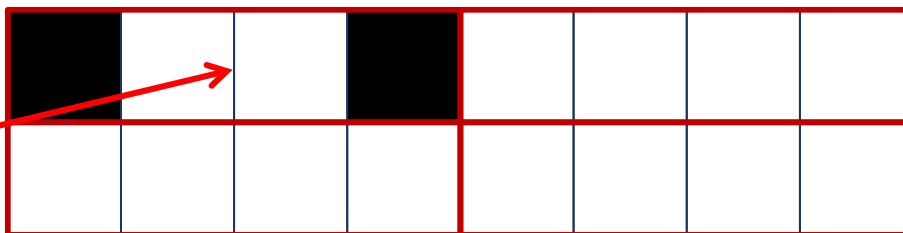

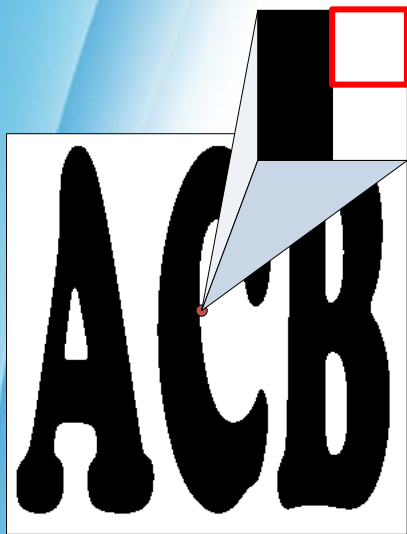

機密影像

$$S_0 \in C_0 \begin{bmatrix} 0 & 1 & 1 & 0 \\ 0 & 1 & 0 & 1 \\ 0 & 0 & 1 & 1 \end{bmatrix}$$

$$S_1 \in C_1 \begin{bmatrix} 1 & 0 & 1 & 0 \\ 1 & 1 & 0 & 0 \\ 1 & 0 & 0 & 1 \end{bmatrix}$$

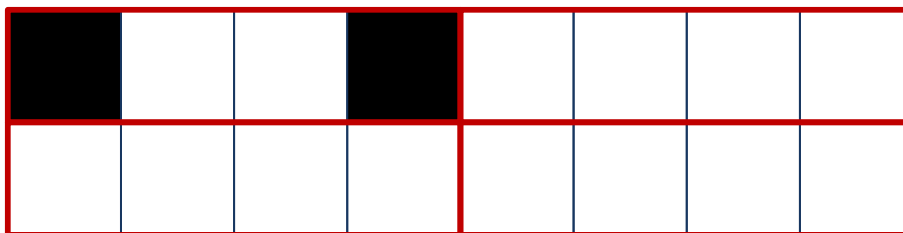

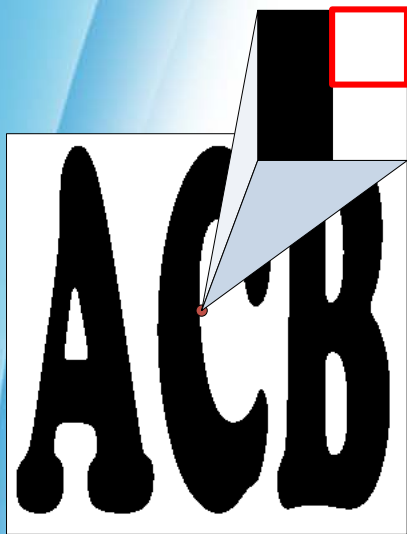

機密影像

$S_0 \in C_0$

1	0	0	1
1	0	1	0
0	0	1	1

$S_1 \in C_1$

1	0	1	0
1	1	0	0
1	0	0	1

■		■					



■	■						



■			■				



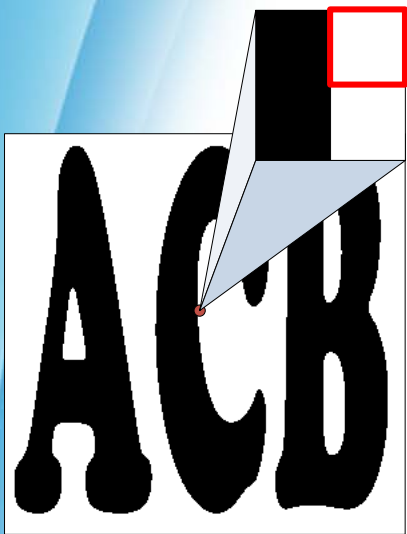

機密影像

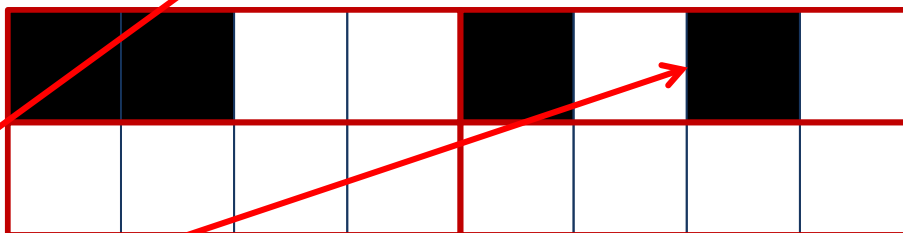
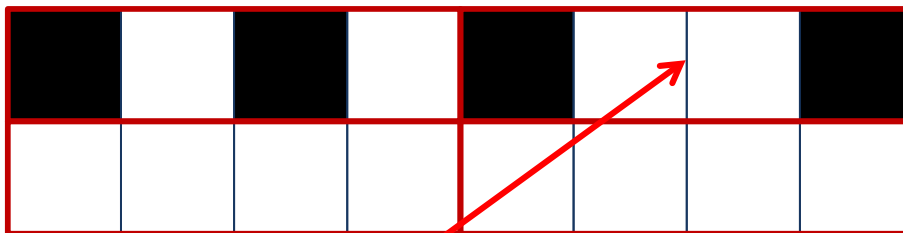

$S_0 \in C_0$

1	0	0	1
1	0	1	0
0	0	1	1

$S_1 \in C_1$

1	0	1	0
1	1	0	0
1	0	0	1

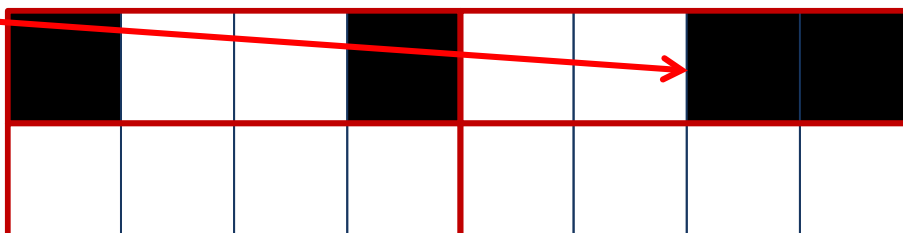

計算機概論



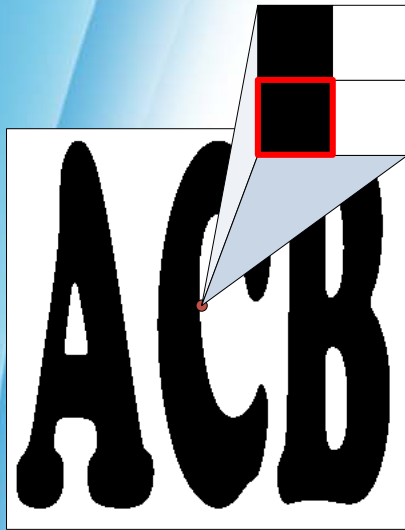

機密影像

$$S_0 \in C_0 \begin{bmatrix} 1 & 0 & 0 & 1 \\ 1 & 0 & 1 & 0 \\ 0 & 0 & 1 & 1 \end{bmatrix}$$

$$S_1 \in C_1 \begin{bmatrix} 1 & 0 & 1 & 0 \\ 1 & 1 & 0 & 0 \\ 1 & 0 & 0 & 1 \end{bmatrix}$$

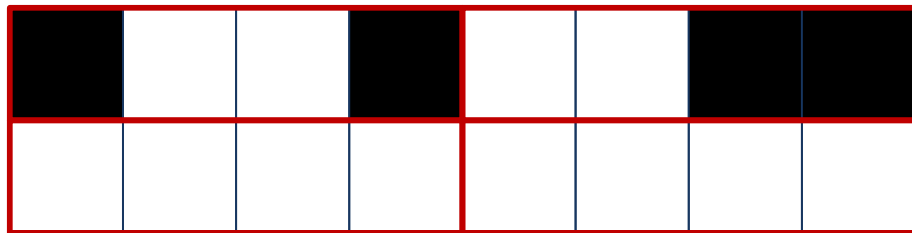
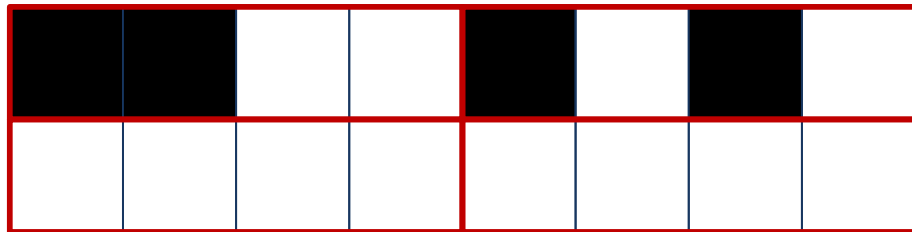
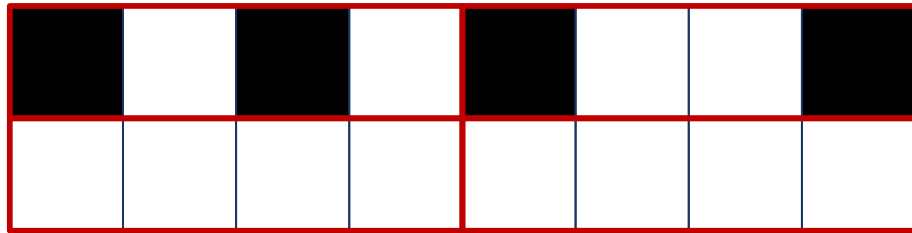

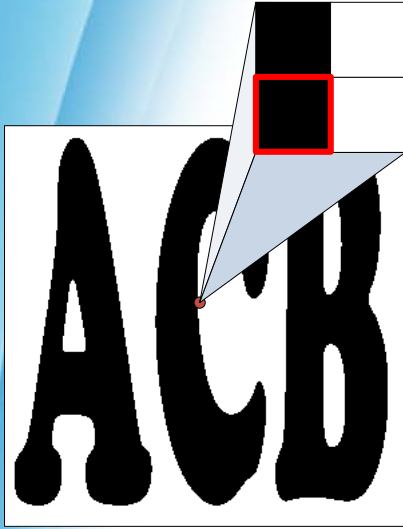

機密影像

$$S_0 \in C_0 \begin{bmatrix} 1 & 0 & 0 & 1 \\ 1 & 0 & 1 & 0 \\ 0 & 0 & 1 & 1 \\ 0 & 1 & 0 & 1 \end{bmatrix}$$

$$S_1 \in C_1 \begin{bmatrix} 1 & 1 & 0 & 0 \\ 0 & 1 & 1 & 0 \end{bmatrix}$$

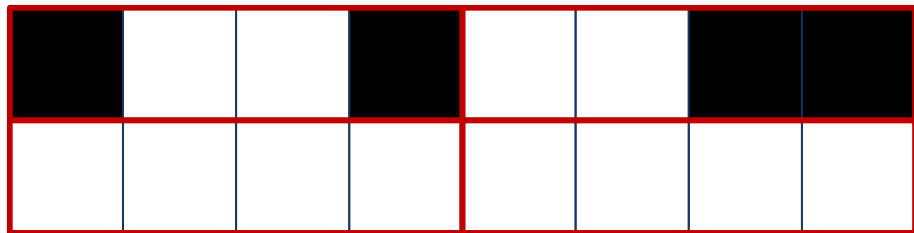
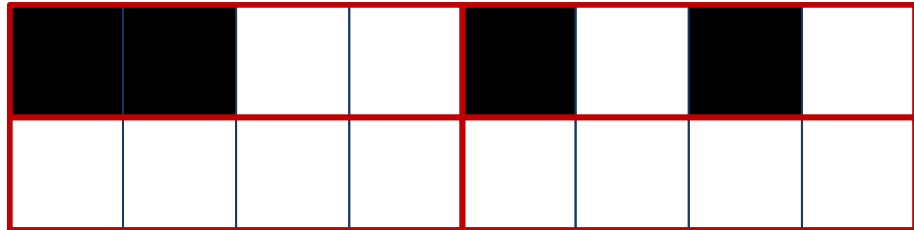
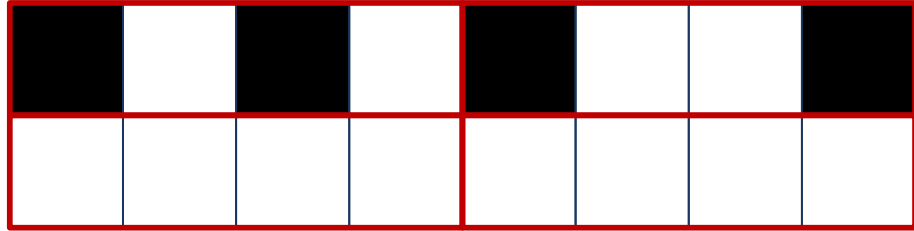

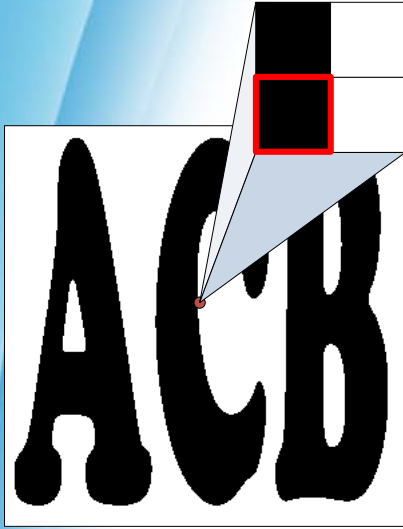

機密影像

$S_0 \in C_0$

$$\begin{bmatrix} 1 & 0 & 0 & 1 \\ 1 & 0 & 1 & 0 \\ 0 & 0 & 1 & 1 \end{bmatrix}$$

$S_1 \in C_1$

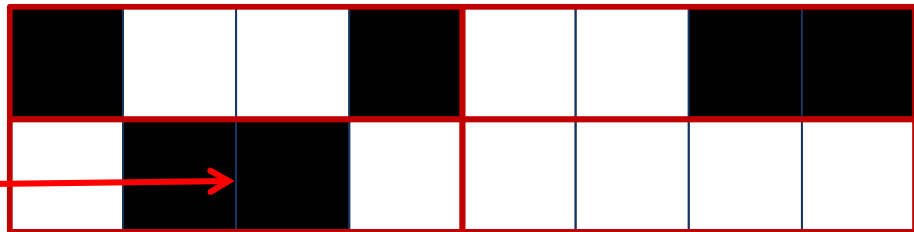
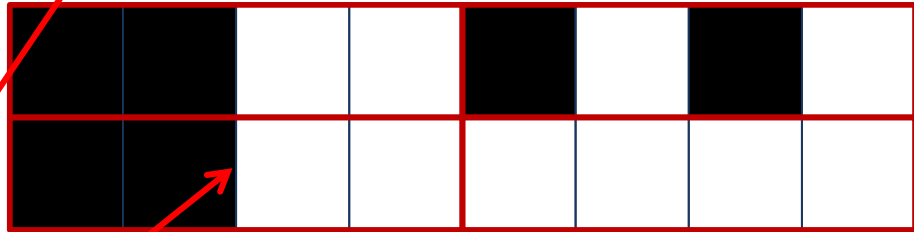
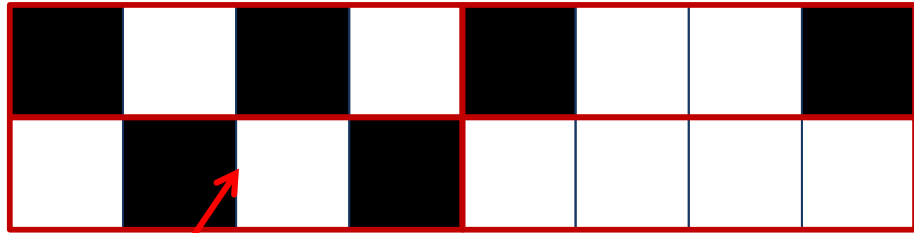
$$\begin{bmatrix} 0 & 1 & 0 & 1 \\ 1 & 1 & 0 & 0 \\ 0 & 1 & 1 & 0 \end{bmatrix}$$

計算機概論



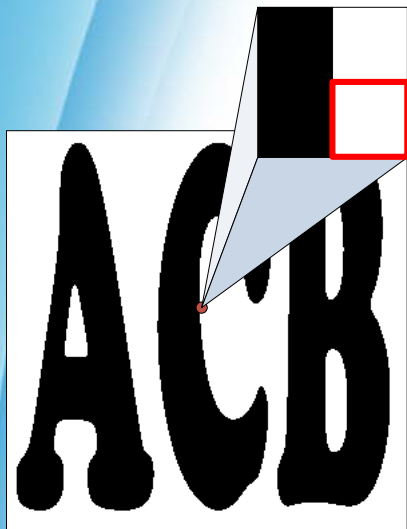

機密影像

$$S_0 \in C_0 \begin{bmatrix} 1 & 0 & 0 & 1 \\ 1 & 0 & 1 & 0 \\ 0 & 0 & 1 & 1 \\ 0 & 1 & 0 & 1 \end{bmatrix}$$

$$S_1 \in C_1 \begin{bmatrix} 1 & 1 & 0 & 0 \\ 1 & 1 & 0 & 0 \\ 0 & 1 & 1 & 0 \end{bmatrix}$$

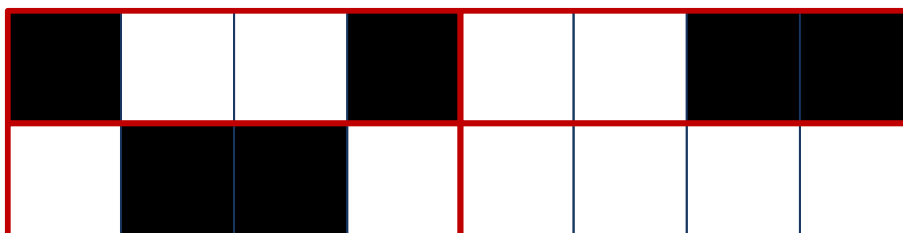
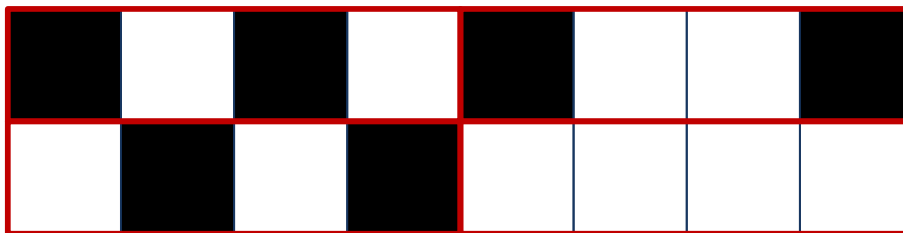

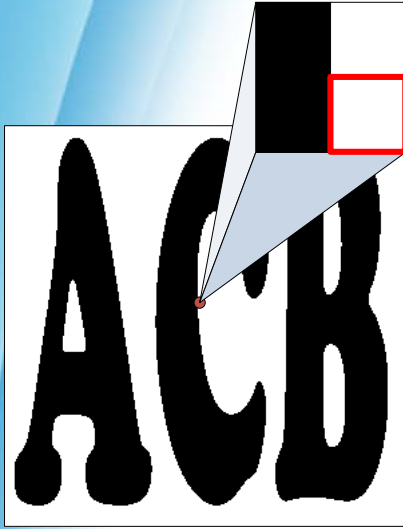

機密影像

$S_0 \in C_0$

0	1	0	1
1	0	0	1
1	1	0	0

$S_1 \in C_1$

0	1	0	1
1	1	0	0
0	1	1	0

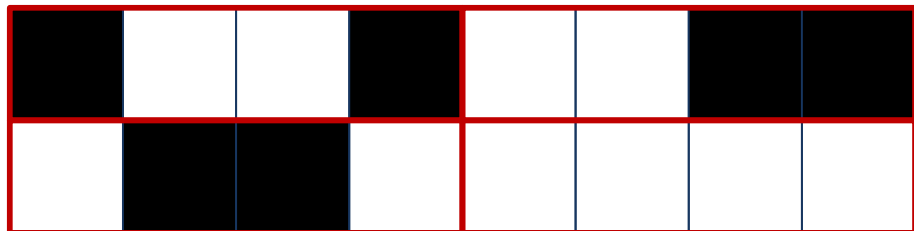
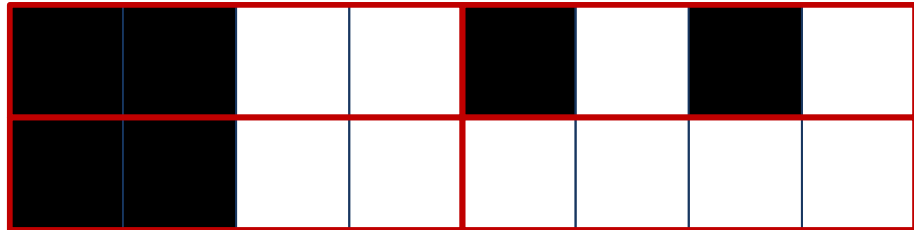
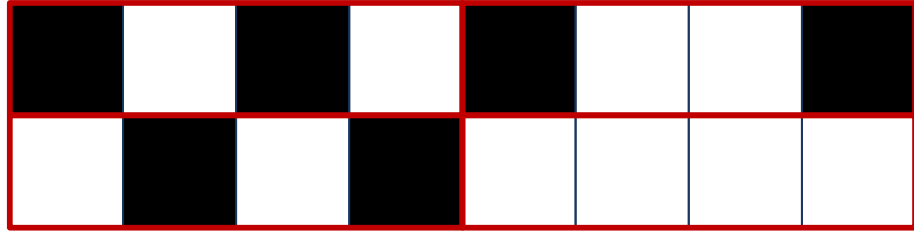

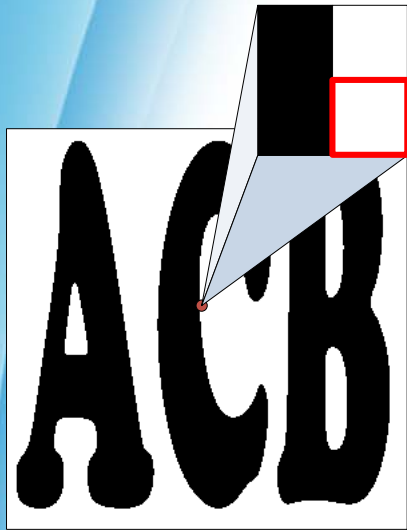

機密影像

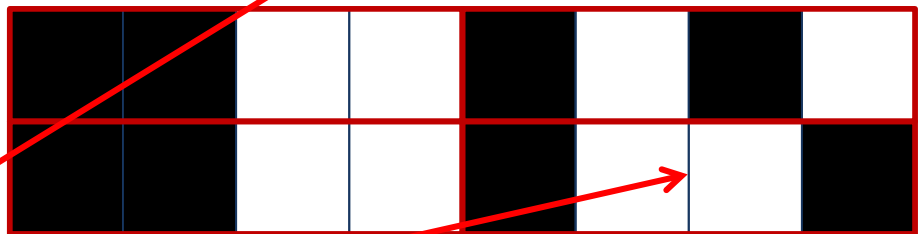
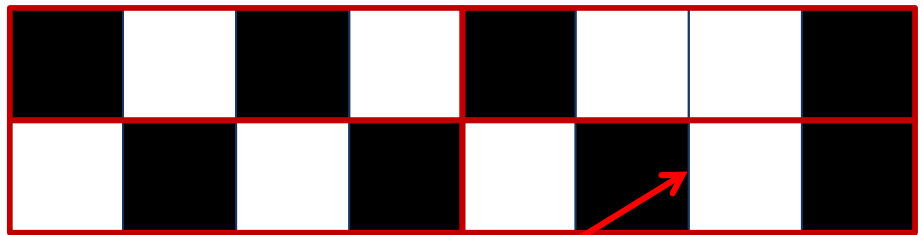

$S_0 \in C_0$

0	1	0	1
1	0	0	1
1	1	0	0

$S_1 \in C_1$

0	1	0	1
1	1	0	0
0	1	1	0

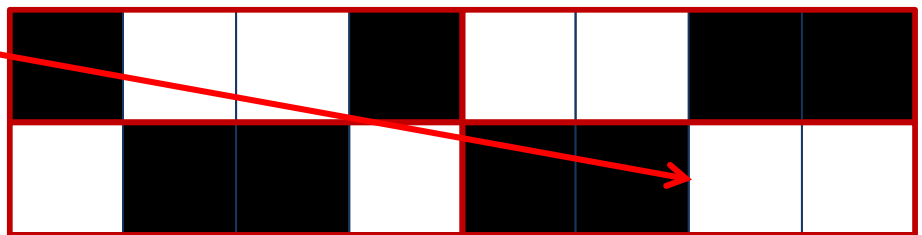

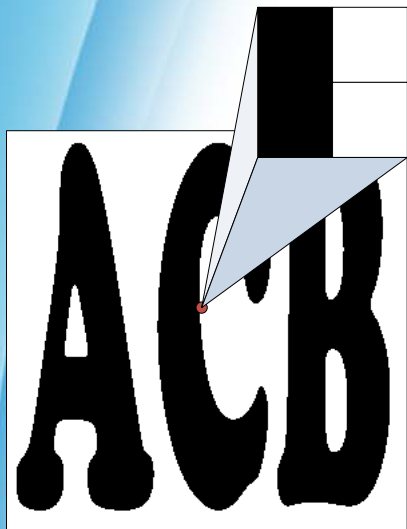

機密影像

$$S_0 \in C_0 \begin{bmatrix} 0 & 1 & 0 & 1 \\ 1 & 0 & 0 & 1 \\ 1 & 1 & 0 & 0 \end{bmatrix}$$

$$S_1 \in C_1 \begin{bmatrix} 0 & 1 & 0 & 1 \\ 1 & 1 & 0 & 0 \\ 0 & 1 & 1 & 0 \end{bmatrix}$$

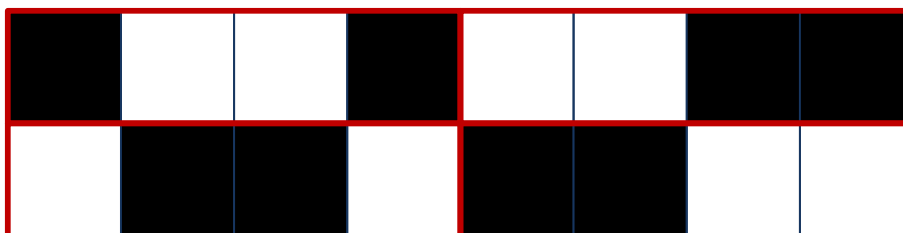
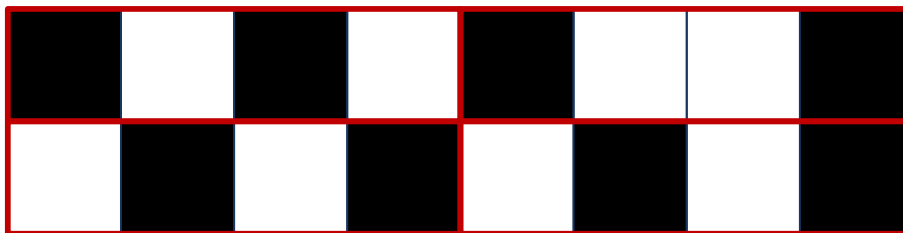

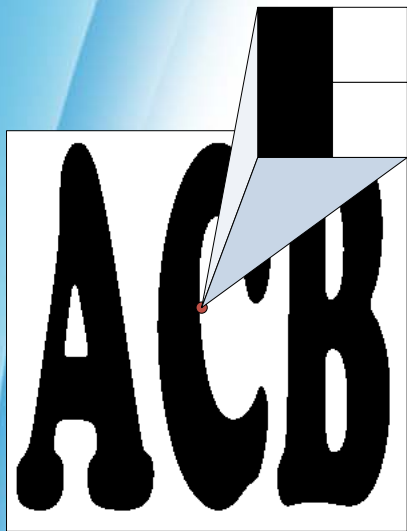

機密影像

$$S_0 \in C_0 \begin{bmatrix} 0 & 1 & 0 & 1 \\ 1 & 0 & 0 & 1 \\ 1 & 1 & 0 & 0 \end{bmatrix}$$

$$S_1 \in C_1 \begin{bmatrix} 0 & 1 & 0 & 1 \\ 1 & 1 & 0 & 0 \\ 0 & 1 & 1 & 0 \end{bmatrix}$$

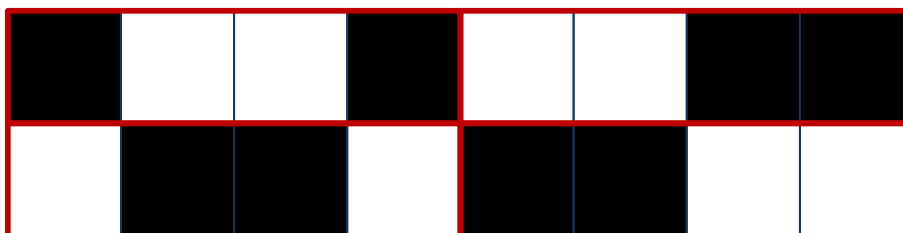
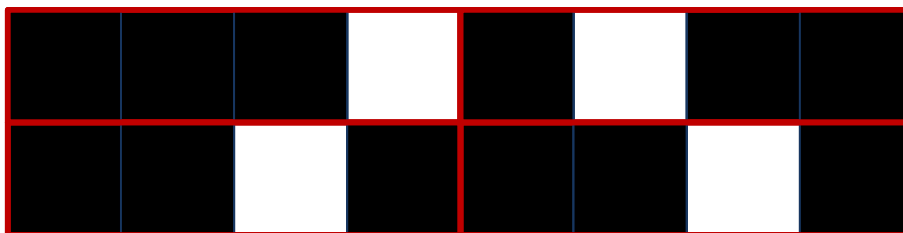

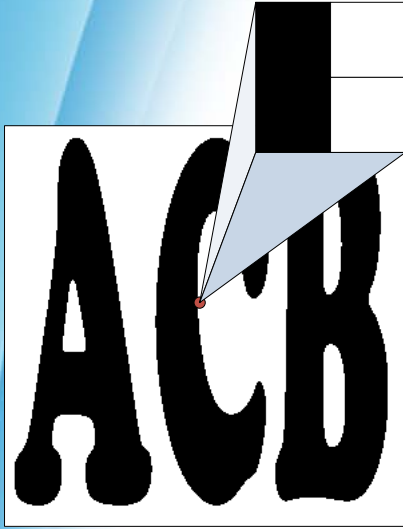

機密影像

$$S_0 \in C_0 \begin{bmatrix} 0 & 1 & 0 & 1 \\ 1 & 0 & 0 & 1 \\ 1 & 1 & 0 & 0 \end{bmatrix}$$

$$S_1 \in C_1 \begin{bmatrix} 0 & 1 & 0 & 1 \\ 1 & 1 & 0 & 0 \\ 0 & 1 & 1 & 0 \end{bmatrix}$$

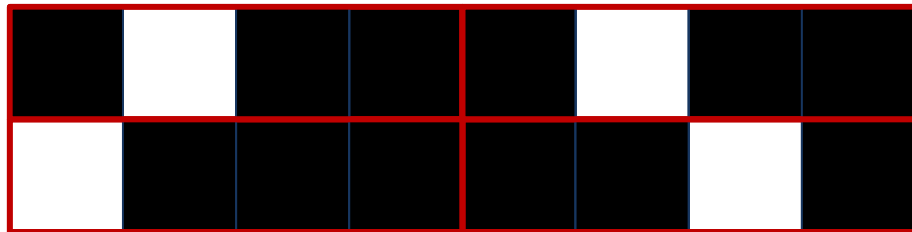
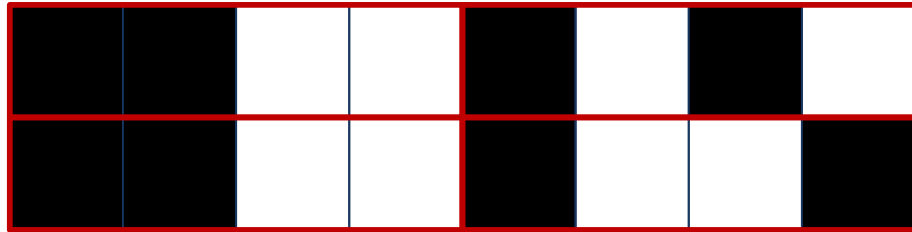



機密影像

$$S_0 \in C_0 \begin{bmatrix} 0 & 1 & 0 & 1 \\ 1 & 0 & 0 & 1 \\ 1 & 1 & 0 & 0 \end{bmatrix}$$

$$S_1 \in C_1 \begin{bmatrix} 0 & 1 & 0 & 1 \\ 1 & 1 & 0 & 0 \\ 0 & 1 & 1 & 0 \end{bmatrix}$$

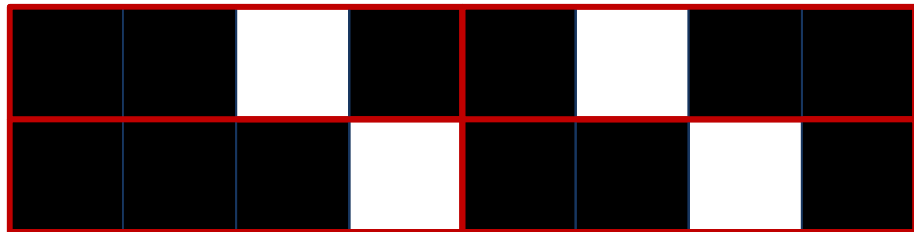
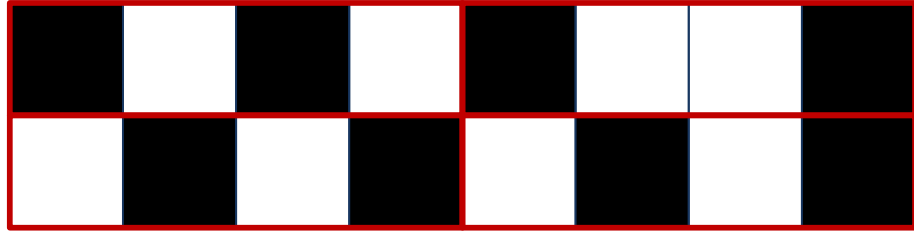

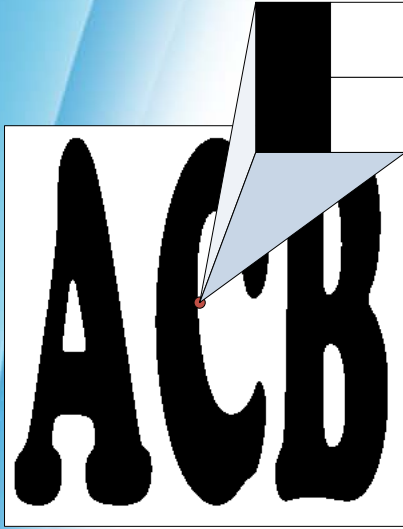

機密影像

$$S_0 \in C_0 \begin{bmatrix} 0 & 1 & 0 & 1 \\ 1 & 0 & 0 & 1 \\ 1 & 1 & 0 & 0 \end{bmatrix}$$

$$S_1 \in C_1 \begin{bmatrix} 0 & 1 & 0 & 1 \\ 1 & 1 & 0 & 0 \\ 0 & 1 & 1 & 0 \end{bmatrix}$$

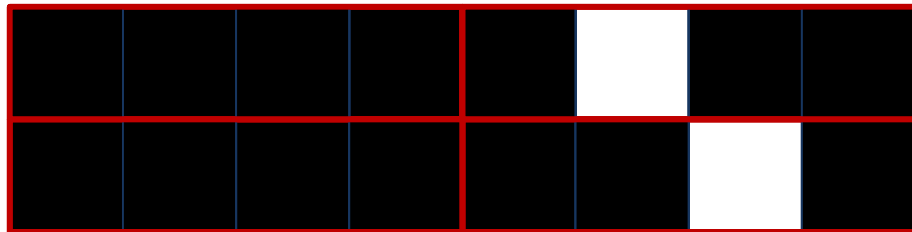

旋轉式視覺密碼

(Wu and Chen, 1998)

p_1	□	□	■	■	□	□	■	■	□	□	■	■	□	□	■	■
p_2	□	■	□	■	□	■	□	■	□	■	□	■	□	■	□	■
s_1	■	■	■	■	■	■	■	■	■	■	■	■	■	■	■	■
s_2	■	■	■	■	■	■	■	■	■	■	■	■	■	■	■	■

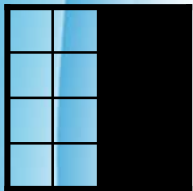

P_1

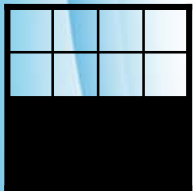
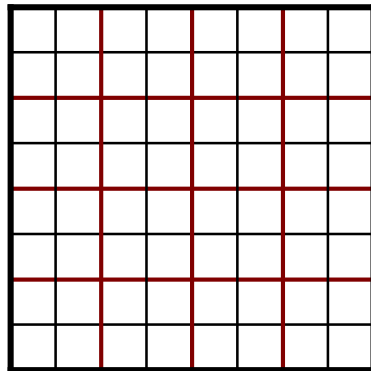

P_2

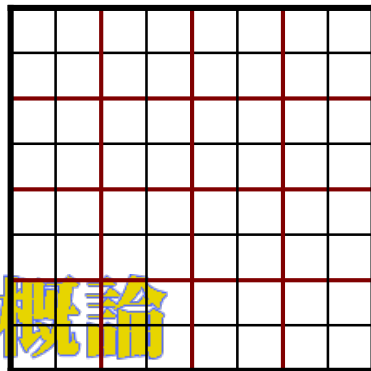

旋轉式視覺密碼

(Wu and Chen, 1998)

p_1	□	□	■	■	□	□	■	■	□	□	■	■	□	□	■	■
p_2	□	■	□	■	□	■	□	■	□	■	□	■	□	■	□	■
s_1	■	■	■	■	■	■	■	■	■	■	■	■	■	■	■	■
s_2	■	■	■	■	■	■	■	■	■	■	■	■	■	■	■	■

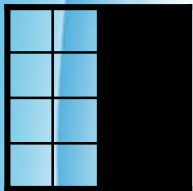

P_1

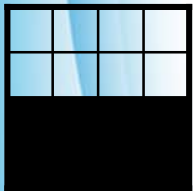
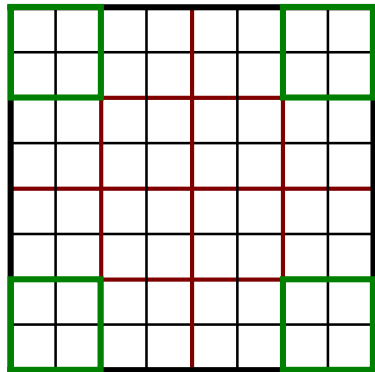

P_2

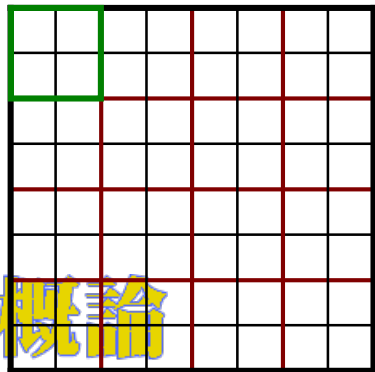

旋轉式視覺密碼

(Wu and Chen, 1998)

p_1	□	□	■	■	□	□	■	■	□	□	■	■	□	□	■	■
p_2	□	■	□	■	□	■	□	■	□	■	□	■	□	■	□	■
s_1	■	■	■	■	■	■	■	■	■	■	■	■	■	■	■	■
s_2	■	■	■	■	■	■	■	■	■	■	■	■	■	■	■	■

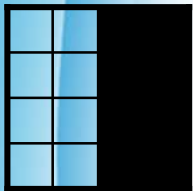

P_1

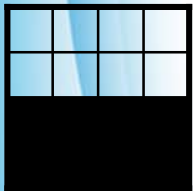
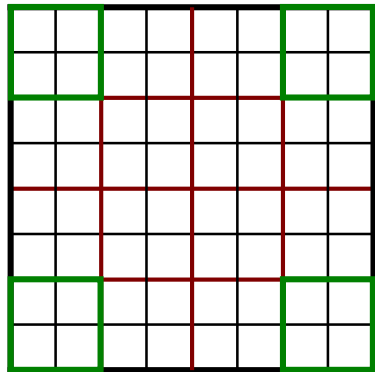

P_2

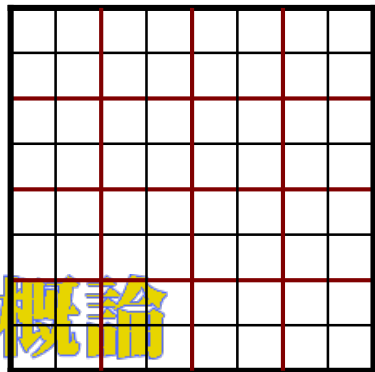

旋轉式視覺密碼

(Wu and Chen, 1998)

p_1	□	□	■	■	□	□	■	■	□	□	■	■	□	□	■	■
p_2	□	■	□	■	□	■	□	■	□	■	□	■	□	■	□	■
s_1	■	■	■	■	■	■	■	■	■	■	■	■	■	■	■	■
s_2	■	■	■	■	■	■	■	■	■	■	■	■	■	■	■	■

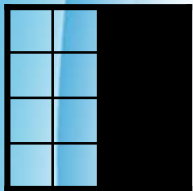

P_1

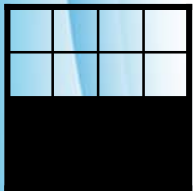
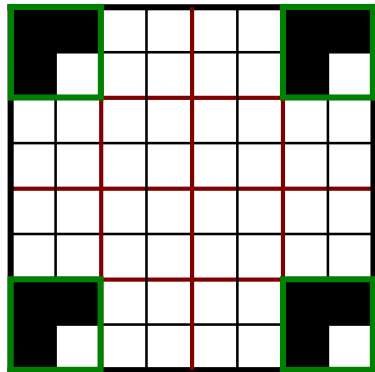

P_2

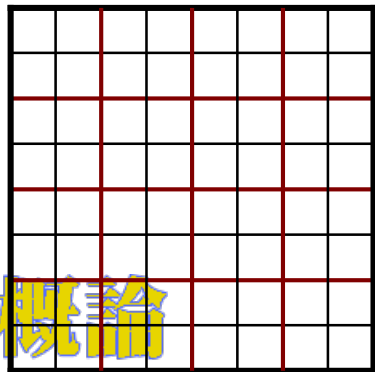

旋轉式視覺密碼

(Wu and Chen, 1998)

p_1	□	□	■	■	□	□	■	■	□	□	■	■	□	□	■	■
p_2	□	■	□	■	□	■	□	■	□	■	□	■	□	■	□	■
s_1	■	■	■	■	■	■	■	■	■	■	■	■	■	■	■	■
s_2	■	■	■	■	■	■	■	■	■	■	■	■	■	■	■	■

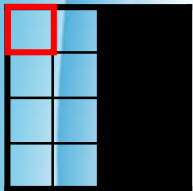

P_1

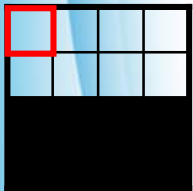
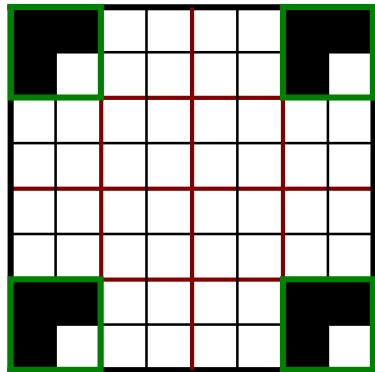

P_2

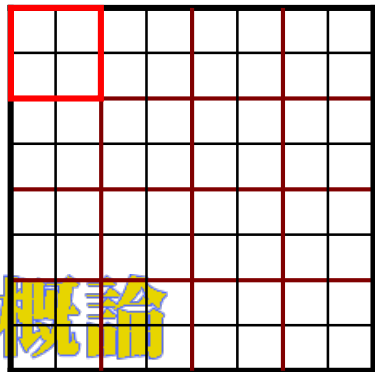

旋轉式視覺密碼

(Wu and Chen, 1998)

p_1	□	□	■	■	□	□	■	■	□	□	■	■	□	□	■	■
p_2	□	■	□	■	□	■	□	■	□	■	□	■	□	■	□	■
s_1	■	■	■	■	■	■	■	■	■	■	■	■	■	■	■	■
s_2	■	■	■	■	■	■	■	■	■	■	■	■	■	■	■	■

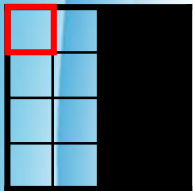

P_1

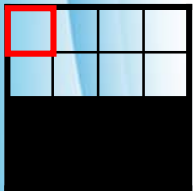
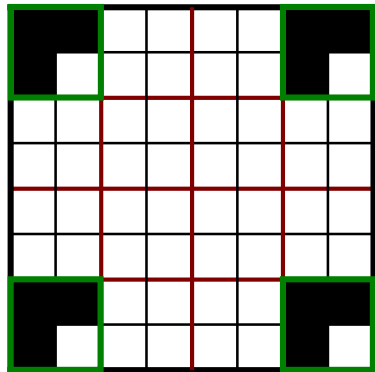

P_2

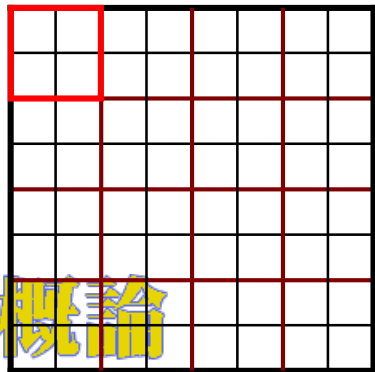

計算機概論



旋轉式視覺密碼

(Wu and Chen, 1998)

p_1	□	□	■	■	□	□	■	■	□	□	■	■	□	□	■	■
p_2	□	■	□	■	□	■	□	■	□	■	□	■	□	■	□	■
s_1	■	■	■	■	■	■	■	■	■	■	■	■	■	■	■	■
s_2	■	■	■	■	■	■	■	■	■	■	■	■	■	■	■	■

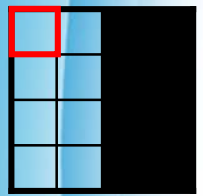

P_1

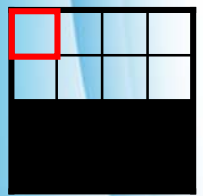
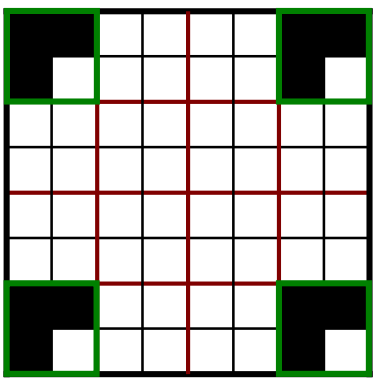

P_2

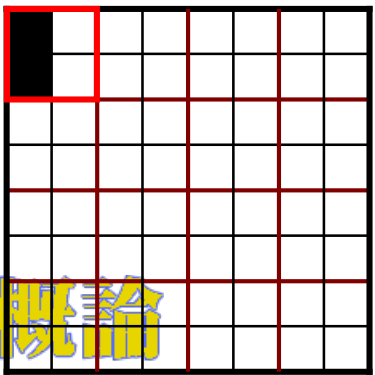

旋轉式視覺密碼

(Wu and Chen, 1998)

p_1	□	□	■	■	□	□	■	■	□	□	■	■	□	□	■	■
p_2	□	■	□	■	□	■	□	■	□	■	□	■	□	■	□	■
s_1	■	■	■	■	■	■	■	■	■	■	■	■	■	■	■	■
s_2	■	■	■	■	■	■	■	■	■	■	■	■	■	■	■	■

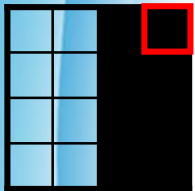

P_1

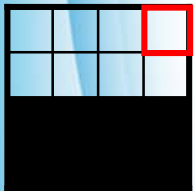
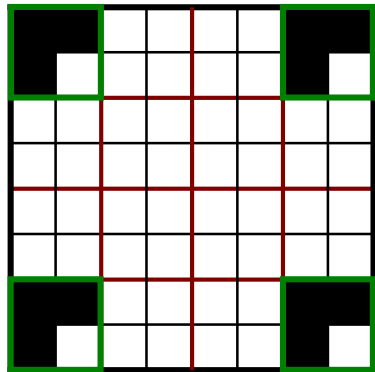

P_2

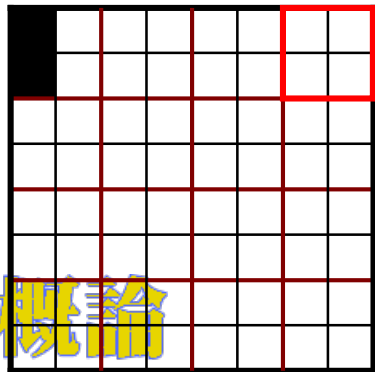

旋轉式視覺密碼

(Wu and Chen, 1998)

p_1	□	□	■	■	□	□	■	■	□	□	■	■	□	□	■	■
p_2	□	■	□	■	□	■	□	■	□	■	□	■	□	■	□	■
s_1	■	■	■	■	■	■	■	■	■	■	■	■	■	■	■	■
s_2	■	■	■	■	■	■	■	■	■	■	■	■	■	■	■	■

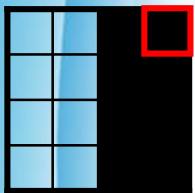

P_1

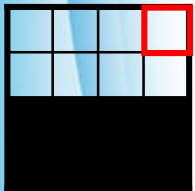
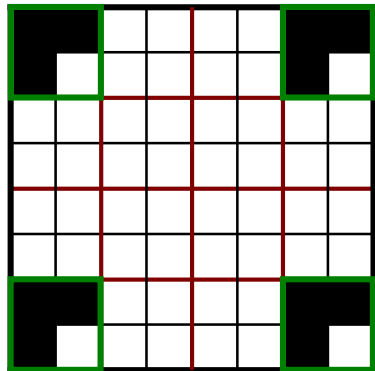

P_2

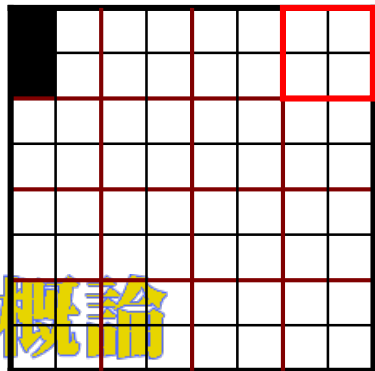

旋轉式視覺密碼

(Wu and Chen, 1998)

p_1	□	□	■	■	□	□	■	■	□	□	■	■	□	□	■	■
p_2	□	■	□	■	□	■	□	■	□	■	□	■	□	■	□	■
s_1	■	■	■	■	■	■	■	■	■	■	■	■	■	■	■	■
s_2	■	■	■	■	■	■	■	■	■	■	■	■	■	■	■	■

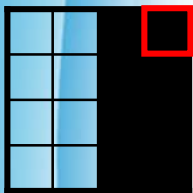

P_1

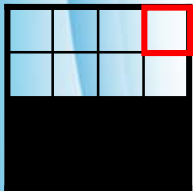
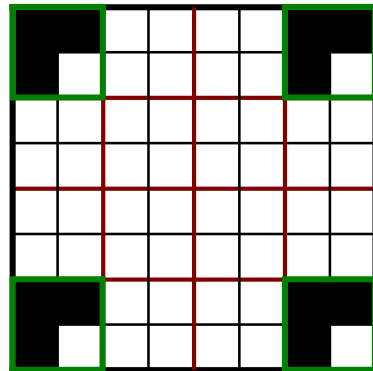

P_2

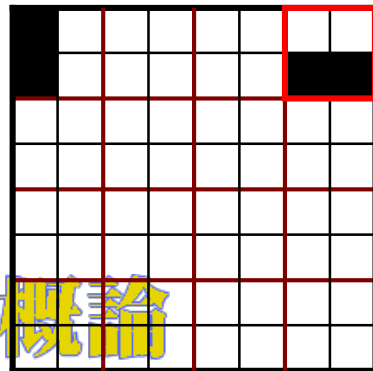

旋轉式視覺密碼

(Wu and Chen, 1998)

p_1	□	□	■	■	□	□	■	■	□	□	■	■	□	□	■	■
p_2	□	■	□	■	□	■	□	■	□	■	□	■	□	■	□	■
s_1	■	■	■	■	■	■	■	■	■	■	■	■	■	■	■	■
s_2	■	■	■	■	■	■	■	■	■	■	■	■	■	■	■	■

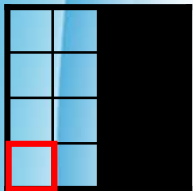

P_1

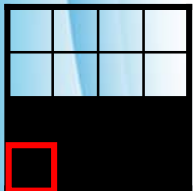
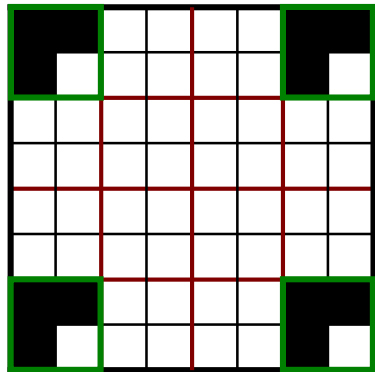

P_2

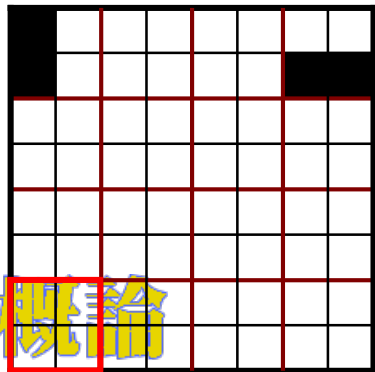

旋轉式視覺密碼

(Wu and Chen, 1998)

p_1	□	□	■	■	□	□	■	■	□	□	■	■	□	□	■	■
p_2	□	■	□	■	□	■	□	■	□	■	□	■	□	■	□	■
s_1	■	■	■	■	■	■	■	■	■	■	■	■	■	■	■	■
s_2	■	■	■	■	■	■	■	■	■	■	■	■	■	■	■	■

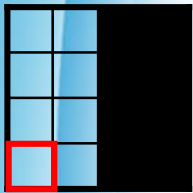

P_1

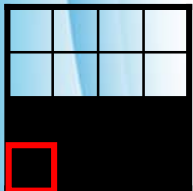
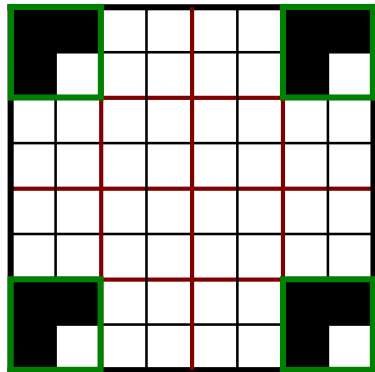

P_2

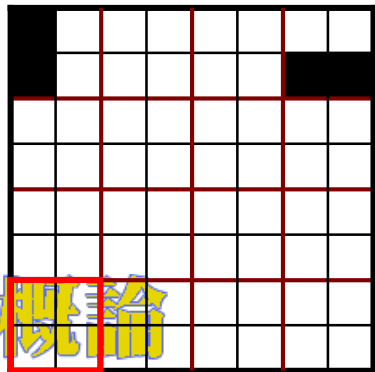

計算機概論



旋轉式視覺密碼

(Wu and Chen, 1998)

p_1	□	□	■	■	□	□	■	■	□	□	■	■	□	□	■	■
p_2	□	■	□	■	□	■	□	■	□	■	□	■	□	■	□	■
s_1	■	■	■	■	■	■	■	■	■	■	■	■	■	■	■	■
s_2	■	■	■	■	■	■	■	■	■	■	■	■	■	■	■	■

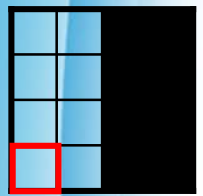

P_1

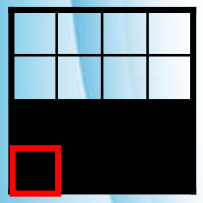
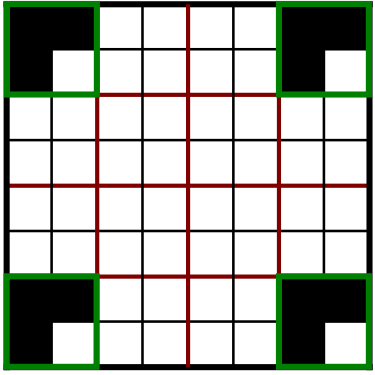

P_2

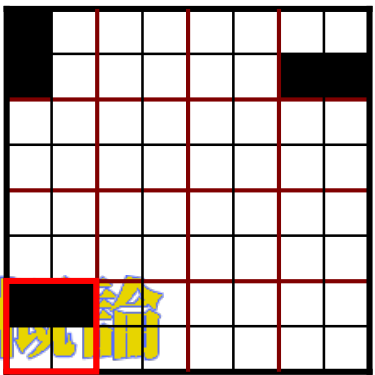

旋轉式視覺密碼

(Wu and Chen, 1998)

p_1	□	□	■	■	□	□	■	■	□	□	■	■	□	□	■	■
p_2	□	■	□	■	□	■	□	■	□	■	□	■	□	■	□	■
s_1	■	■	■	■	■	■	■	■	■	■	■	■	■	■	■	■
s_2	■	■	■	■	■	■	■	■	■	■	■	■	■	■	■	■

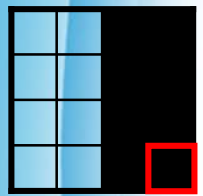

P_1

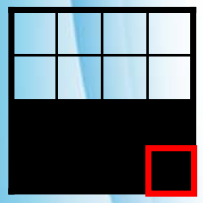
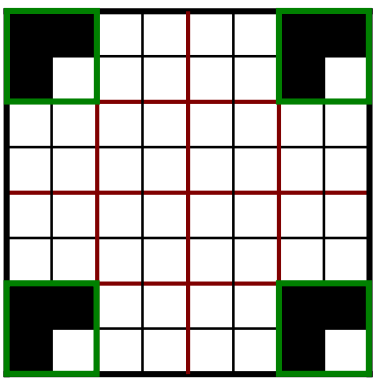

P_2

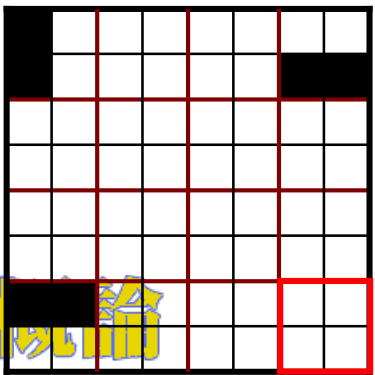

旋轉式視覺密碼

(Wu and Chen, 1998)

p_1	□	□	■	■	□	□	■	■	□	□	■	■	□	□	■	■
p_2	□	■	□	■	□	■	□	■	□	■	□	■	□	■	□	■
s_1	■	■	■	■	■	■	■	■	■	■	■	■	■	■	■	■
s_2	■	■	■	■	■	■	■	■	■	■	■	■	■	■	■	■

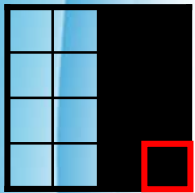

P_1

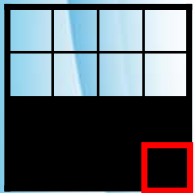
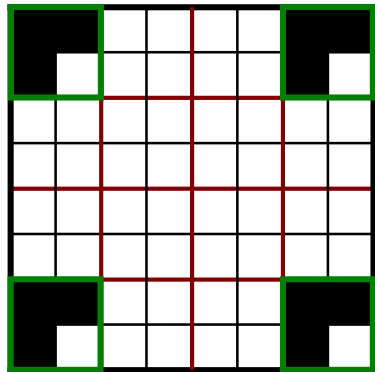

P_2

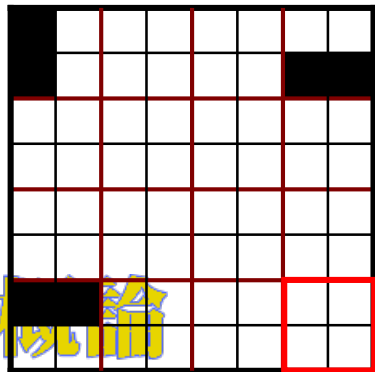

旋轉式視覺密碼

(Wu and Chen, 1998)

p_1	□	□	■	■	□	□	■	■	□	□	■	■	□	□	■	■
p_2	□	■	□	■	□	■	□	■	□	■	□	■	□	■	□	■
s_1	■	■	■	■	■	■	■	■	■	■	■	■	■	■	■	■
s_2	■	■	■	■	■	■	■	■	■	■	■	■	■	■	■	■

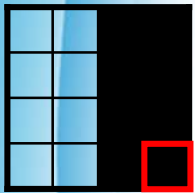

P_1

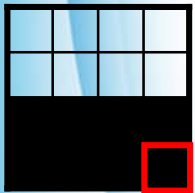
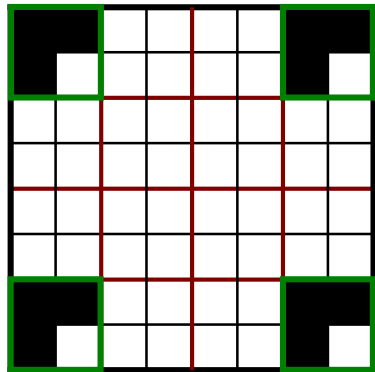

P_2

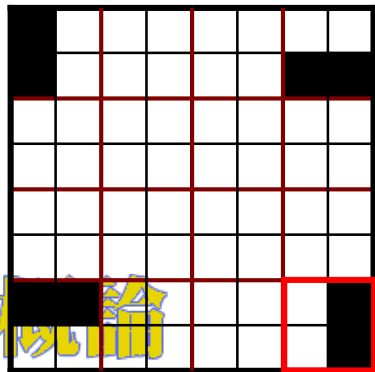

旋轉式視覺密碼

(Wu and Chen, 1998)

p_1	□	□	■	■	□	□	■	■	□	□	■	■	□	□	■	■
p_2	□	■	□	■	□	■	□	■	□	■	□	■	□	■	□	■
s_1	■	■	■	■	■	■	■	■	■	■	■	■	■	■	■	■
s_2	■	■	■	■	■	■	■	■	■	■	■	■	■	■	■	■

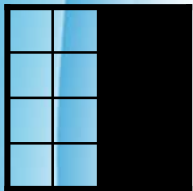

P_1

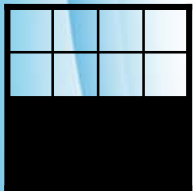
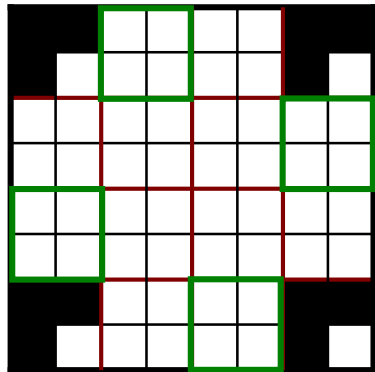

P_2

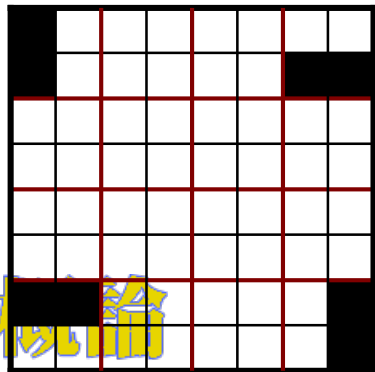

旋轉式視覺密碼

(Wu and Chen, 1998)

p_1	□	□	■	■	□	□	■	■	□	□	■	■	□	□	■	■
p_2	□	■	□	■	□	■	□	■	□	■	□	■	□	■	□	■
s_1	■	■	■	■	■	■	■	■	■	■	■	■	■	■	■	■
s_2	■	■	■	■	■	■	■	■	■	■	■	■	■	■	■	■

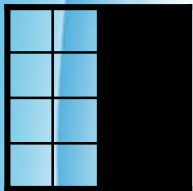

P_1

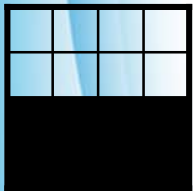
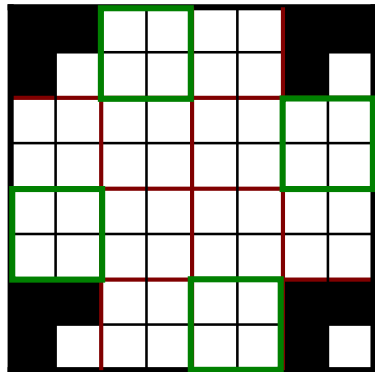

P_2

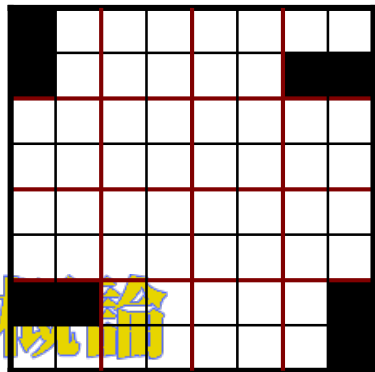

旋轉式視覺密碼

(Wu and Chen, 1998)

p_1	□	□	■	■	□	□	■	■	□	□	■	■	□	□	■	■
p_2	□	■	□	■	□	■	□	■	□	■	□	■	□	■	□	■
s_1	■	■	■	■	■	■	■	■	■	■	■	■	■	■	■	■
s_2	■	■	■	■	■	■	■	■	■	■	■	■	■	■	■	■

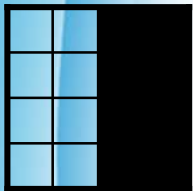

P_1

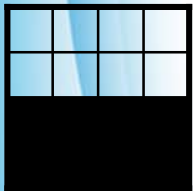
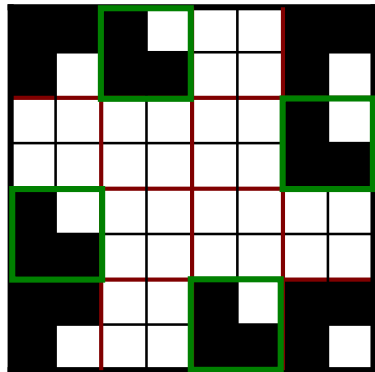

P_2

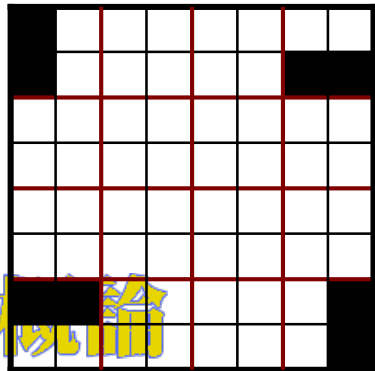

旋轉式視覺密碼

(Wu and Chen, 1998)

p_1	□	□	■	■	□	□	■	■	□	□	■	■	□	□	■	■
p_2	□	■	□	■	□	■	□	■	□	■	□	■	□	■	□	■
s_1	■	■	■	■	■	■	■	■	■	■	■	■	■	■	■	■
s_2	■	■	■	■	■	■	■	■	■	■	■	■	■	■	■	■

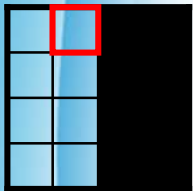

P_1

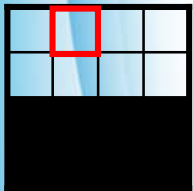
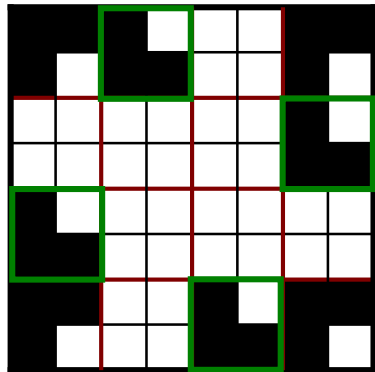

P_2

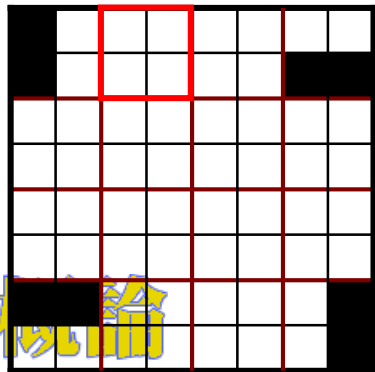

旋轉式視覺密碼

(Wu and Chen, 1998)

p_1	□	□	■	■	□	□	■	■	□	□	■	■	□	□	■	■
p_2	□	■	□	■	□	■	□	■	□	■	□	■	□	■	□	■
s_1	■	■	■	■	■	■	■	■	■	■	■	■	■	■	■	■
s_2	■	■	■	■	■	■	■	■	■	■	■	■	■	■	■	■

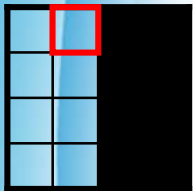

P_1

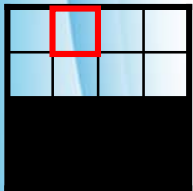
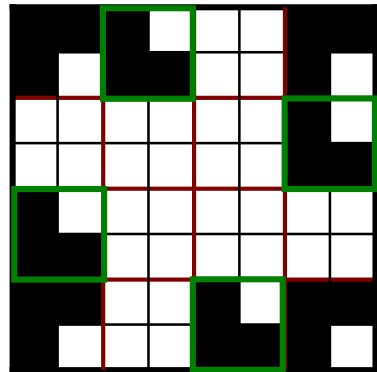

P_2

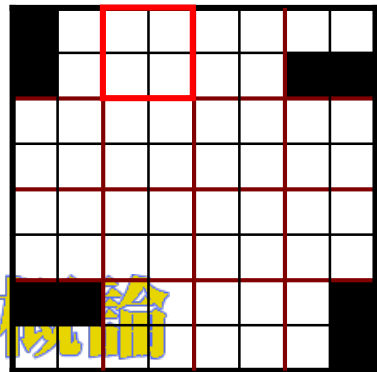

旋轉式視覺密碼

(Wu and Chen, 1998)

p_1	□	□	■	■	□	□	■	■	□	□	■	■	□	□	■	■
p_2	□	■	□	■	□	■	□	■	□	■	□	■	□	■	□	■
s_1	■	■	■	■	■	■	■	■	■	■	■	■	■	■	■	■
s_2	■	■	■	■	■	■	■	■	■	■	■	■	■	■	■	■

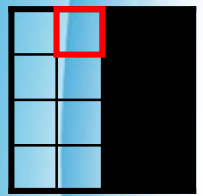

P_1

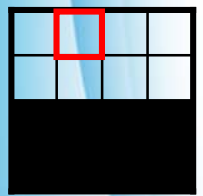
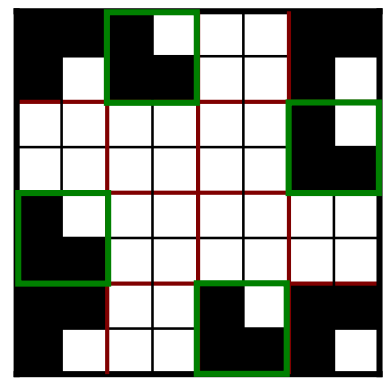

P_2

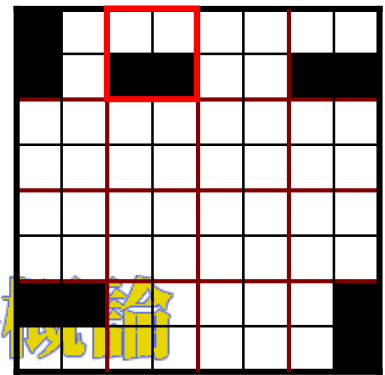

旋轉式視覺密碼

(Wu and Chen, 1998)

p_1	□	□	■	■	□	□	■	■	□	□	■	■	□	□	■	■
p_2	□	■	□	■	□	■	□	■	□	■	□	■	□	■	□	■
s_1	■	■	■	■	■	■	■	■	■	■	■	■	■	■	■	■
s_2	■	■	■	■	■	■	■	■	■	■	■	■	■	■	■	■

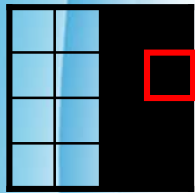

P_1

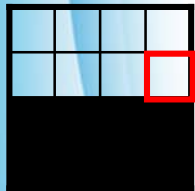
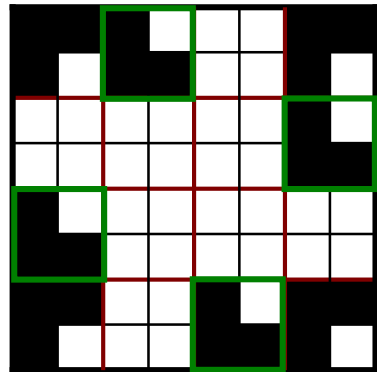

P_2

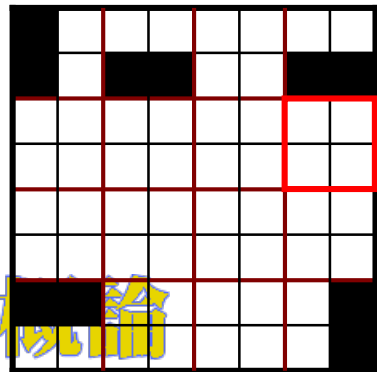

旋轉式視覺密碼

(Wu and Chen, 1998)

p_1	□	□	■	■	□	□	■	■	□	□	■	■	□	□	■	■
p_2	□	■	□	■	□	■	□	■	□	■	□	■	□	■	□	■
s_1	■	■	■	■	■	■	■	■	■	■	■	■	■	■	■	■
s_2	■	■	■	■	■	■	■	■	■	■	■	■	■	■	■	■

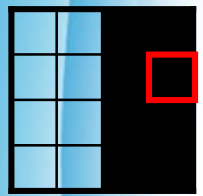

P_1

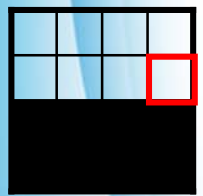
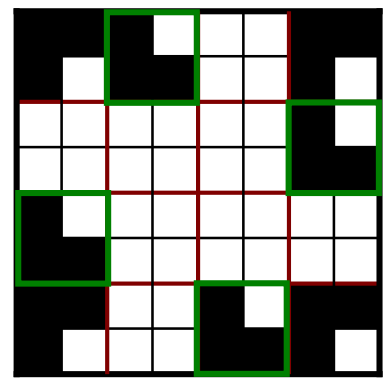

P_2

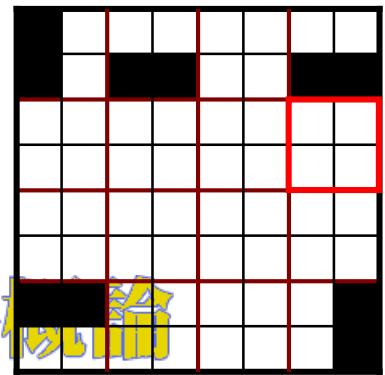

旋轉式視覺密碼

(Wu and Chen, 1998)

p_1	□	□	■	■	□	□	■	■	□	□	■	■	□	□	■	■
p_2	□	■	□	■	□	■	□	■	□	■	□	■	□	■	□	■
s_1	■	■	■	■	■	■	■	■	■	■	■	■	■	■	■	■
s_2	■	■	■	■	■	■	■	■	■	■	■	■	■	■	■	■

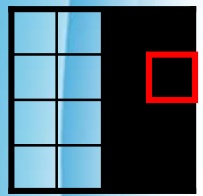

P_1

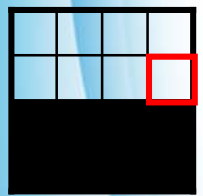
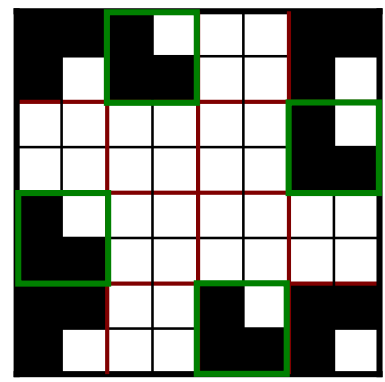

P_2

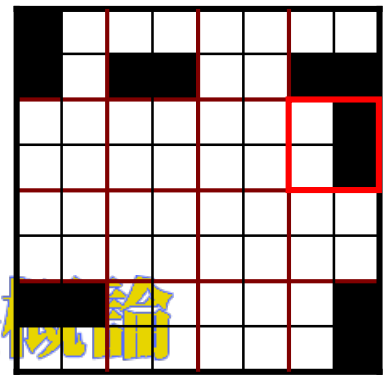

旋轉式視覺密碼

(Wu and Chen, 1998)

p_1	□	□	■	■	□	□	■	■	□	□	■	■	□	□	■	■
p_2	□	■	□	■	□	■	□	■	□	■	□	■	□	■	□	■
s_1	■	■	■	■	■	■	■	■	■	■	■	■	■	■	■	■
s_2	■	■	■	■	■	■	■	■	■	■	■	■	■	■	■	■

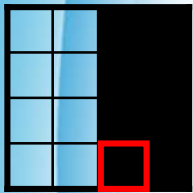

P_1

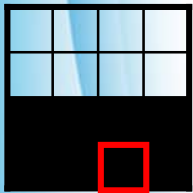
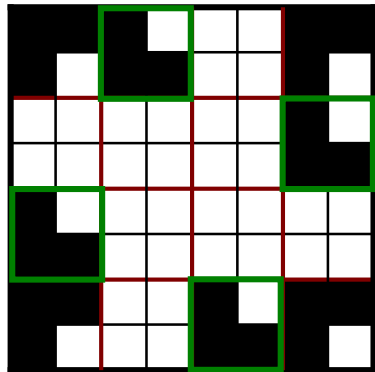

P_2

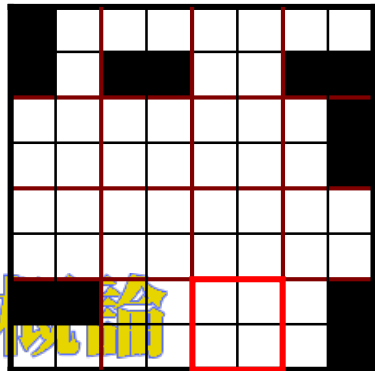

旋轉式視覺密碼

(Wu and Chen, 1998)

p_1	□	□	■	■	□	□	■	■	□	□	■	■	□	□	■	■
p_2	□	■	□	■	□	■	□	■	□	■	□	■	□	■	□	■
s_1	■	■	■	■	■	■	■	■	■	■	■	■	■	■	■	■
s_2	■	■	■	■	■	■	■	■	■	■	■	■	■	■	■	■

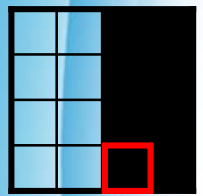

P_1

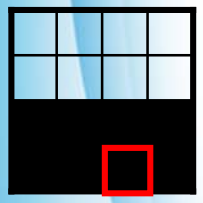
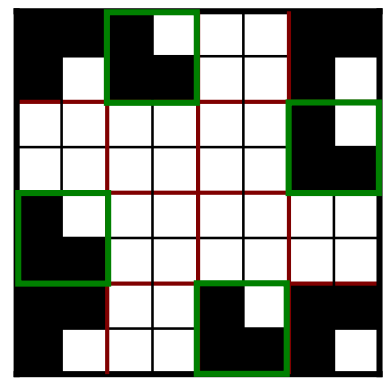

P_2

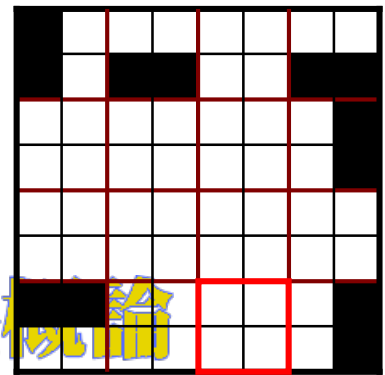

旋轉式視覺密碼

(Wu and Chen, 1998)

p_1	□	□	■	■	□	□	■	■	□	□	■	■	□	□	■	■
p_2	□	■	□	■	□	■	□	■	□	■	□	■	□	■	□	■
s_1	■	■	■	■	■	■	■	■	■	■	■	■	■	■	■	■
s_2	■	■	■	■	■	■	■	■	■	■	■	■	■	■	■	■

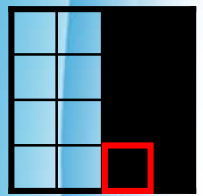

P_1

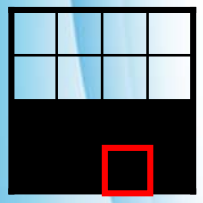
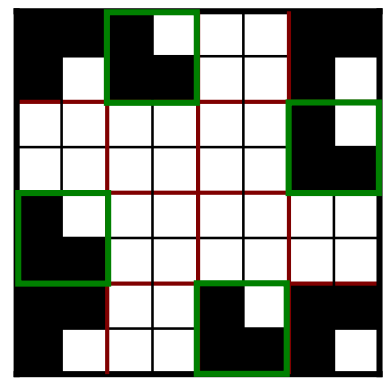

P_2

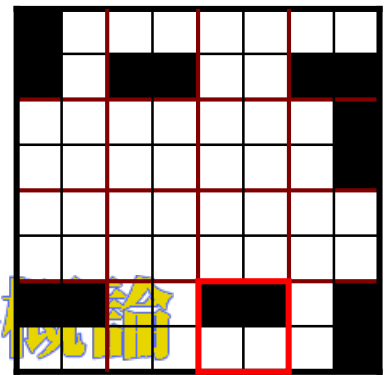

旋轉式視覺密碼

(Wu and Chen, 1998)

p_1	□	□	■	■	□	□	■	■	□	□	■	■	□	□	■	■
p_2	□	■	□	■	□	■	□	■	□	■	□	■	□	■	□	■
s_1	■	■	■	■	■	■	■	■	■	■	■	■	■	■	■	■
s_2	■	■	■	■	■	■	■	■	■	■	■	■	■	■	■	■

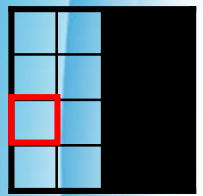

P_1

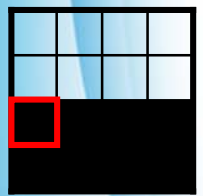
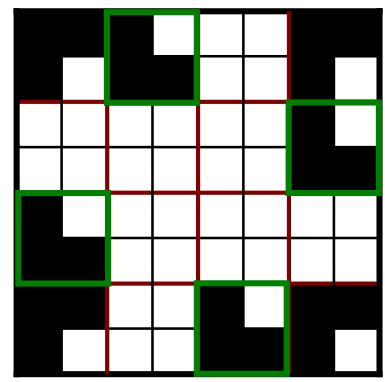

P_2

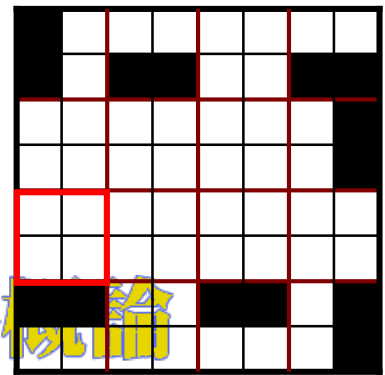

旋轉式視覺密碼

(Wu and Chen, 1998)

p_1	□	□	■	■	□	□	■	■	□	□	■	■	□	□	■	■
p_2	□	■	□	■	□	■	□	■	□	■	□	■	□	■	□	■
s_1	■	■	■	■	■	■	■	■	■	■	■	■	■	■	■	■
s_2	■	■	■	■	■	■	■	■	■	■	■	■	■	■	■	■

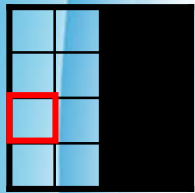

P_1

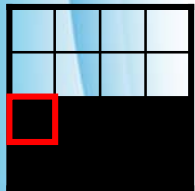
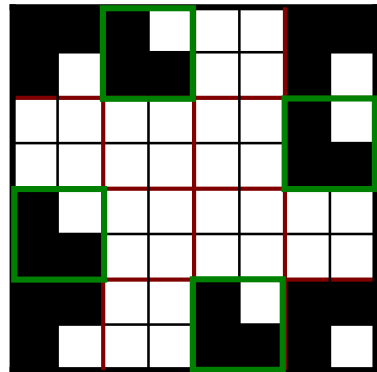

P_2

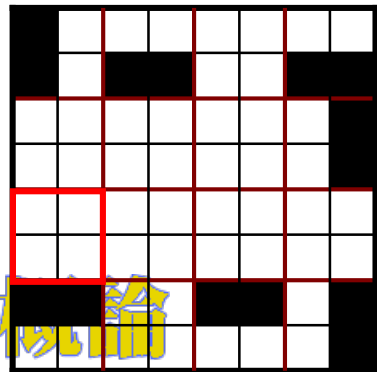

旋轉式視覺密碼

(Wu and Chen, 1998)

p_1	□	□	■	■	□	□	■	■	□	□	■	■	□	□	■	■
p_2	□	■	□	■	□	■	□	■	□	■	□	■	□	■	□	■
s_1	■	■	■	■	■	■	■	■	■	■	■	■	■	■	■	■
s_2	■	■	■	■	■	■	■	■	■	■	■	■	■	■	■	■

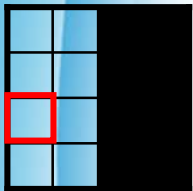

P_1

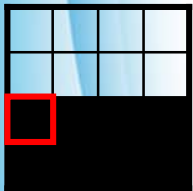
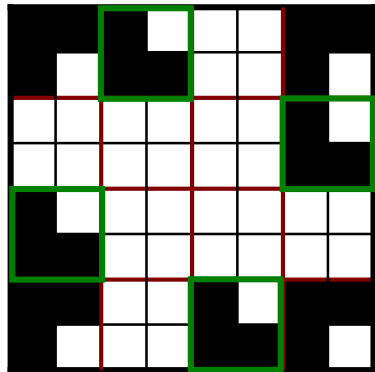

P_2

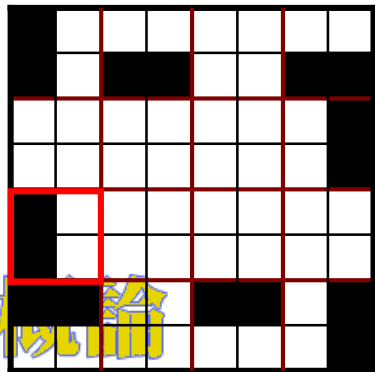

旋轉式視覺密碼

(Wu and Chen, 1998)

p_1	□	□	■	■	□	□	■	■	□	□	■	■	□	□	■	■
p_2	□	■	□	■	□	■	□	■	□	■	□	■	□	■	□	■
s_1	■	■	■	■	■	■	■	■	■	■	■	■	■	■	■	■
s_2	■	■	■	■	■	■	■	■	■	■	■	■	■	■	■	■

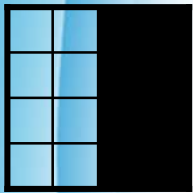

P_1

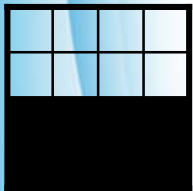
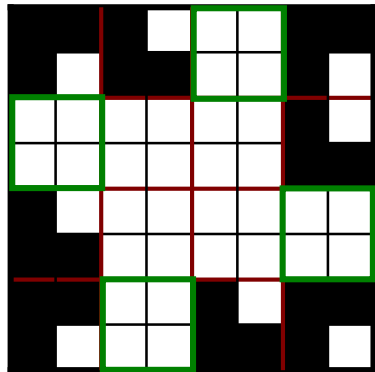

P_2

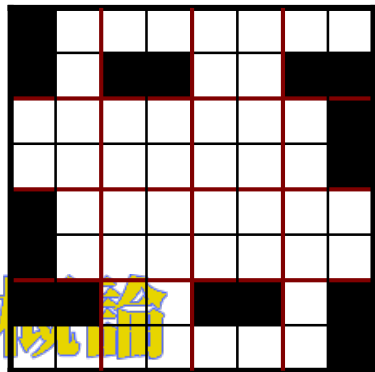

旋轉式視覺密碼

(Wu and Chen, 1998)

p_1	□	□	■	■	□	□	■	■	□	□	■	■	□	□	■	■
p_2	□	■	□	■	□	■	□	■	□	■	□	■	□	■	□	■
s_1	■	■	■	■	■	■	■	■	■	■	■	■	■	■	■	■
s_2	■	■	■	■	■	■	■	■	■	■	■	■	■	■	■	■

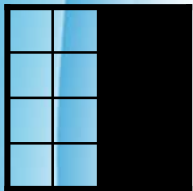

P_1

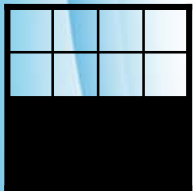
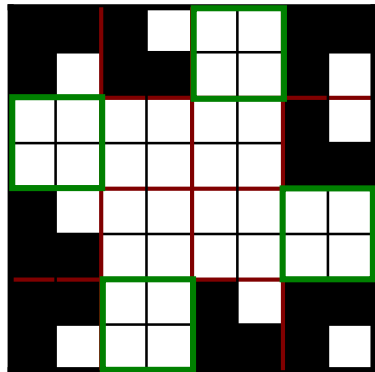

P_2

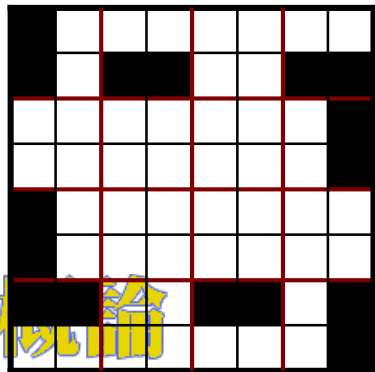

旋轉式視覺密碼

(Wu and Chen, 1998)

p_1	□	□	■	■	□	□	■	■	□	□	■	■	□	□	■	■
p_2	□	■	□	■	□	■	□	■	□	■	□	■	□	■	□	■
s_1	■	■	■	■	■	■	■	■	■	■	■	■	■	■	■	■
s_2	■	■	■	■	■	■	■	■	■	■	■	■	■	■	■	■

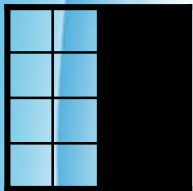

P_1

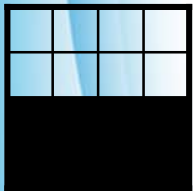
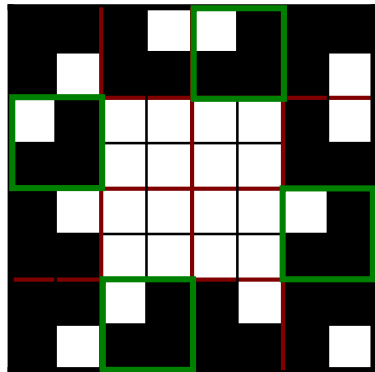

P_2

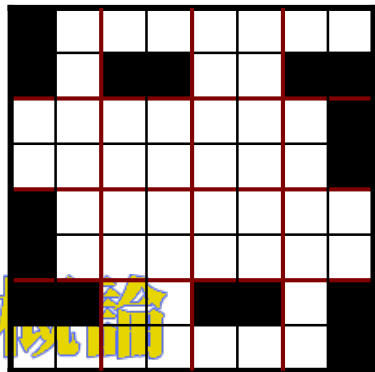

旋轉式視覺密碼

(Wu and Chen, 1998)

p_1	□	□	■	■	□	□	■	■	□	□	■	■	□	□	■	■
p_2	□	■	□	■	□	■	□	■	□	■	□	■	□	■	□	■
s_1	■	■	■	■	■	■	■	■	■	■	■	■	■	■	■	■
s_2	■	■	■	■	■	■	■	■	■	■	■	■	■	■	■	■

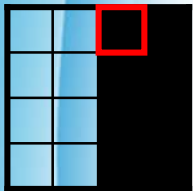

P_1

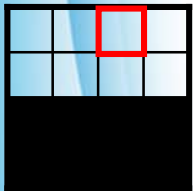
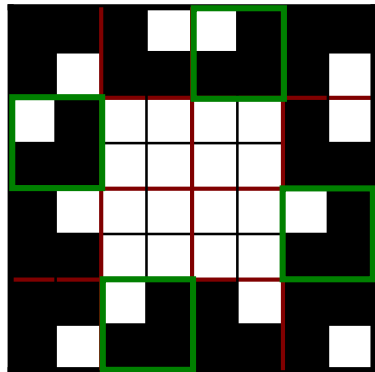

P_2

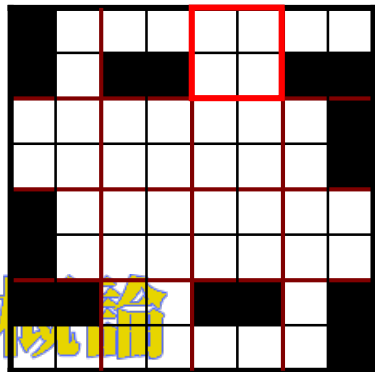

旋轉式視覺密碼

(Wu and Chen, 1998)

p_1	□	□	■	■	□	□	■	■	□	□	■	■	□	□	■	■
p_2	□	■	□	■	□	■	□	■	□	■	□	■	□	■	□	■
s_1	■	■	■	■	■	■	■	■	■	■	■	■	■	■	■	■
s_2	■	■	■	■	■	■	■	■	■	■	■	■	■	■	■	■

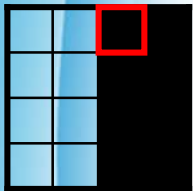

P_1

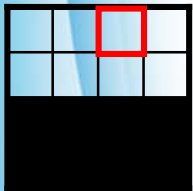
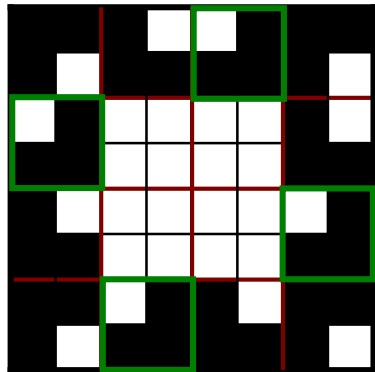

P_2

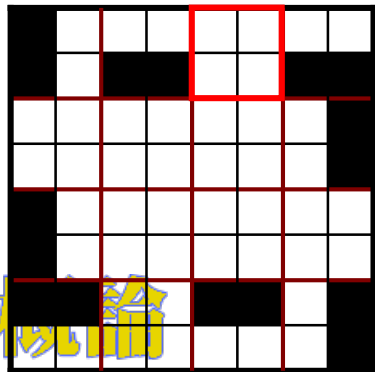

旋轉式視覺密碼

(Wu and Chen, 1998)

p_1	□	□	■	■	□	□	■	■	□	□	■	■	□	□	■	■
p_2	□	■	□	■	□	■	□	■	□	■	□	■	□	■	□	■
s_1	■	■	■	■	■	■	■	■	■	■	■	■	■	■	■	■
s_2	■	■	■	■	■	■	■	■	■	■	■	■	■	■	■	■

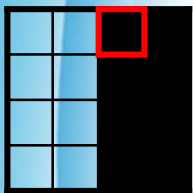

P_1

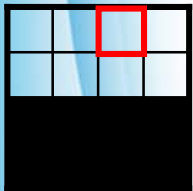
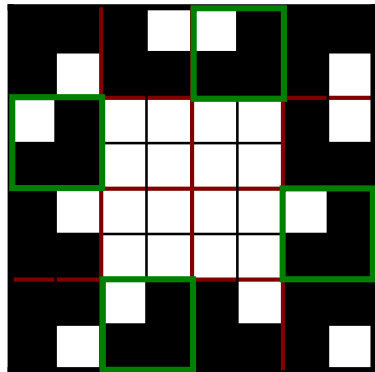

P_2

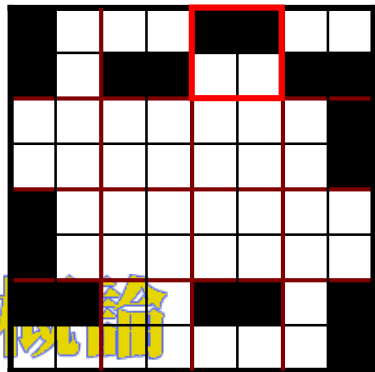

旋轉式視覺密碼

(Wu and Chen, 1998)

p_1	□	□	■	■	□	□	■	■	□	□	■	■	□	□	■	■
p_2	□	■	□	■	□	■	□	■	□	■	□	■	□	■	□	■
s_1	■	■	■	■	■	■	■	■	■	■	■	■	■	■	■	■
s_2	■	■	■	■	■	■	■	■	■	■	■	■	■	■	■	■

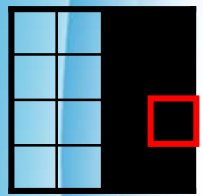

P_1

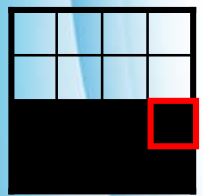
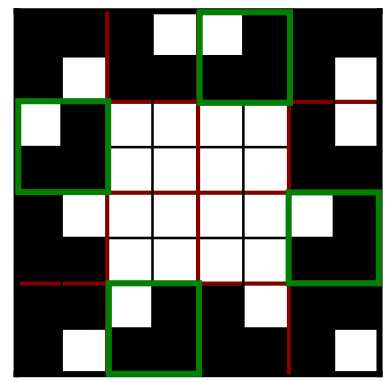

P_2

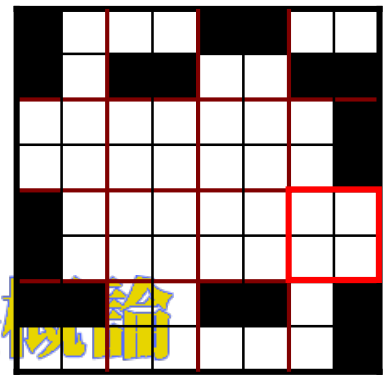

旋轉式視覺密碼

(Wu and Chen, 1998)

p_1	□	□	■	■	□	□	■	■	□	□	■	■	□	□	■	■
p_2	□	■	□	■	□	■	□	■	□	■	□	■	□	■	□	■
s_1	■	■	■	■	■	■	■	■	■	■	■	■	■	■	■	■
s_2	■	■	■	■	■	■	■	■	■	■	■	■	■	■	■	■

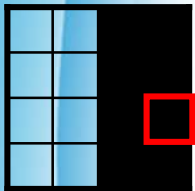

P_1

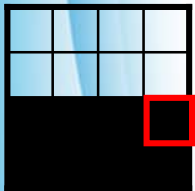
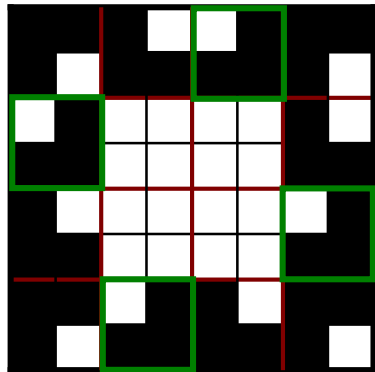

P_2

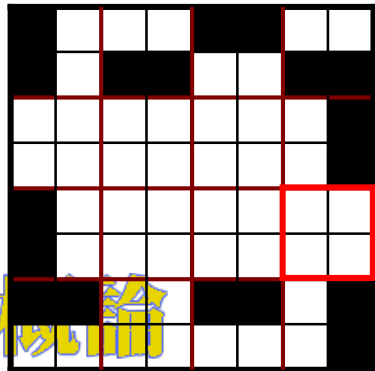

計算機概論



旋轉式視覺密碼

(Wu and Chen, 1998)

p_1	□	□	■	■	□	□	■	■	□	□	■	■	□	□	■	■
p_2	□	■	□	■	□	■	□	■	□	■	□	■	□	■	□	■
s_1	■	■	■	■	■	■	■	■	■	■	■	■	■	■	■	■
s_2	■	■	■	■	■	■	■	■	■	■	■	■	■	■	■	■

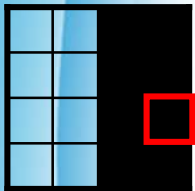

P_1

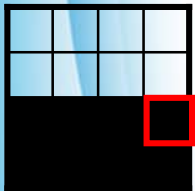
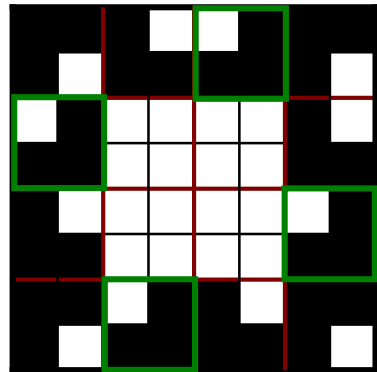

P_2

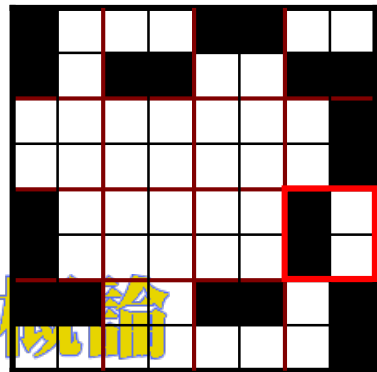

計算機概論



旋轉式視覺密碼

(Wu and Chen, 1998)

p_1	□	□	■	■	□	□	■	■	□	□	■	■	□	□	■	■
p_2	□	■	□	■	□	■	□	■	□	■	□	■	□	■	□	■
s_1	■	■	■	■	■	■	■	■	■	■	■	■	■	■	■	■
s_2	■	■	■	■	■	■	■	■	■	■	■	■	■	■	■	■

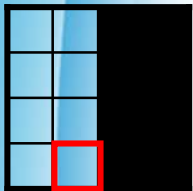

P_1

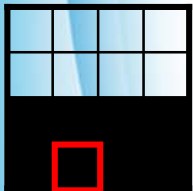
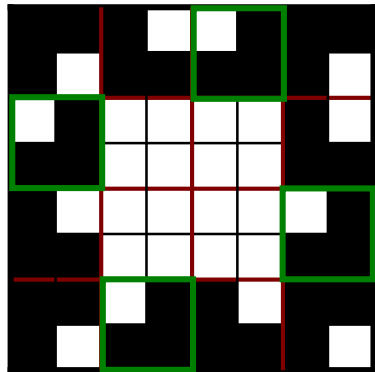

P_2

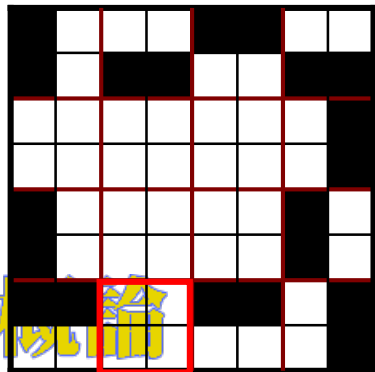

計算機概論



旋轉式視覺密碼

(Wu and Chen, 1998)

p_1	□	□	■	■	□	□	■	■	□	□	■	■	□	□	■	■
p_2	□	■	□	■	□	■	□	■	□	■	□	■	□	■	□	■
s_1	■	■	■	■	■	■	■	■	■	■	■	■	■	■	■	■
s_2	■	■	■	■	■	■	■	■	■	■	■	■	■	■	■	■

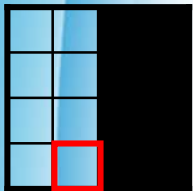

P_1

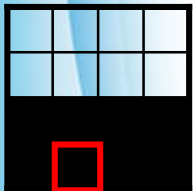
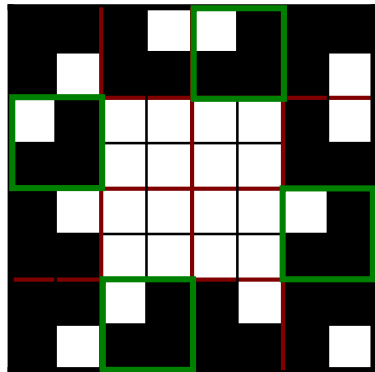

P_2

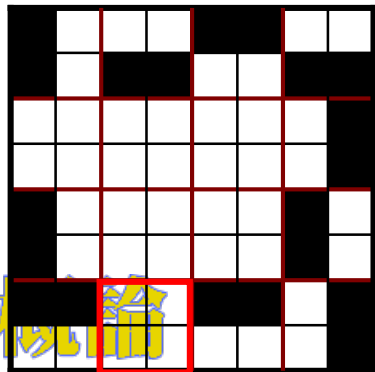

計算機概論



旋轉式視覺密碼

(Wu and Chen, 1998)

p_1	□	□	■	■	□	□	■	■	□	□	■	■	□	□	■	■
p_2	□	■	□	■	□	■	□	■	□	■	□	■	□	■	□	■
s_1	■	■	■	■	■	■	■	■	■	■	■	■	■	■	■	■
s_2	■	■	■	■	■	■	■	■	■	■	■	■	■	■	■	■

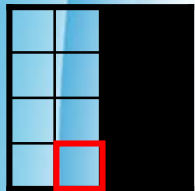

P_1

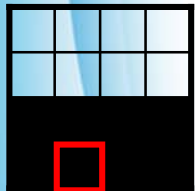
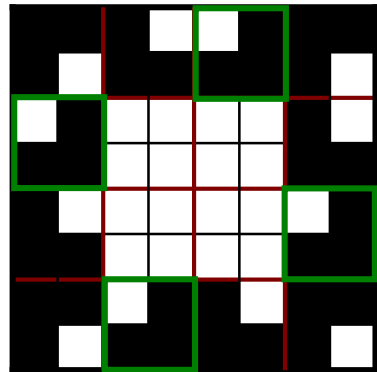

P_2

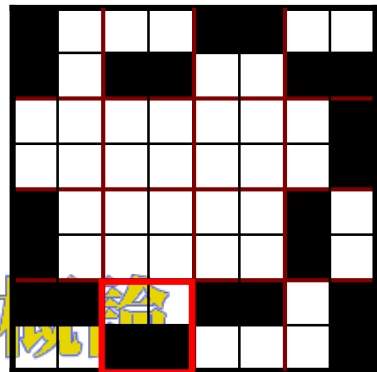

旋轉式視覺密碼

(Wu and Chen, 1998)

p_1	□	□	■	■	□	□	■	■	□	□	■	■	□	□	■	■
p_2	□	■	□	■	□	■	□	■	□	■	□	■	□	■	□	■
s_1	■	■	■	■	■	■	■	■	■	■	■	■	■	■	■	■
s_2	■	■	■	■	■	■	■	■	■	■	■	■	■	■	■	■

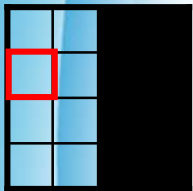

P_1

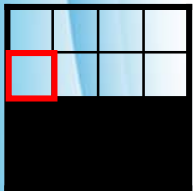
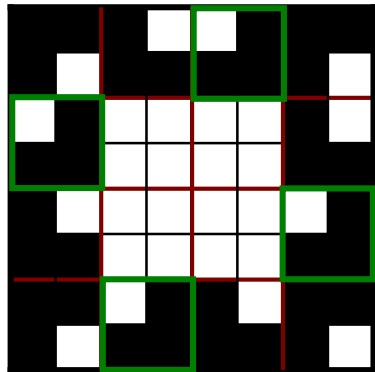

P_2

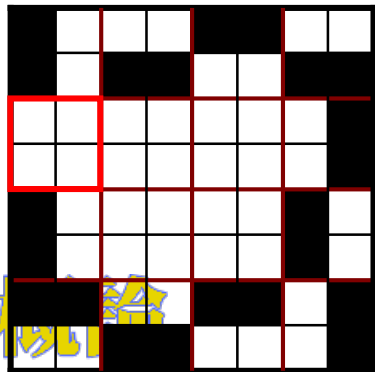

旋轉式視覺密碼

(Wu and Chen, 1998)

p_1	□	□	■	■	□	□	■	■	□	□	■	■	□	□	■	■
p_2	□	■	□	■	□	■	□	■	□	■	□	■	□	■	□	■
s_1	■	■	■	■	■	■	■	■	■	■	■	■	■	■	■	■
s_2	■	■	■	■	■	■	■	■	■	■	■	■	■	■	■	■

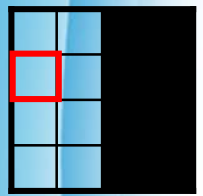

P_1

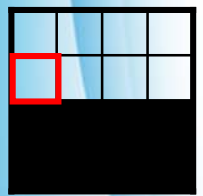
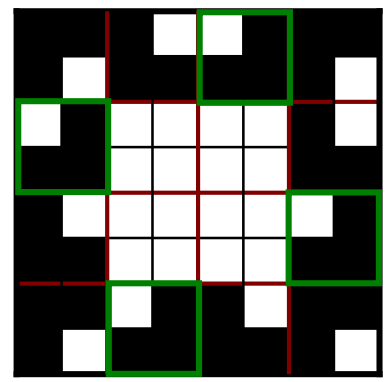

P_2

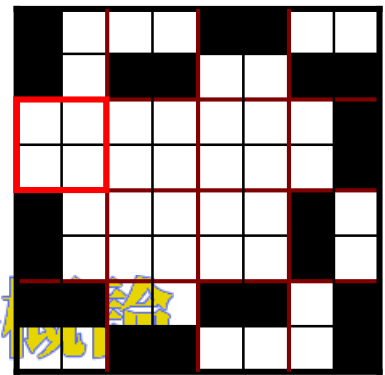

旋轉式視覺密碼

(Wu and Chen, 1998)

p_1	□	□	■	■	□	□	■	■	□	□	■	■	□	□	■	■
p_2	□	■	□	■	□	■	□	■	□	■	□	■	□	■	□	■
s_1	■	■	■	■	■	■	■	■	■	■	■	■	■	■	■	■
s_2	■	■	■	■	■	■	■	■	■	■	■	■	■	■	■	■

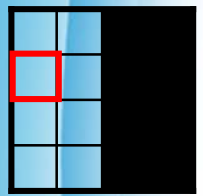

P_1

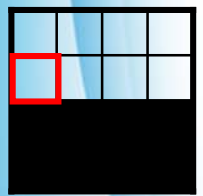
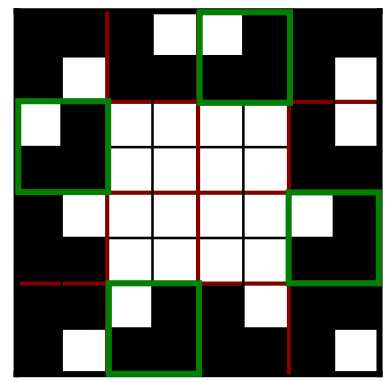

P_2

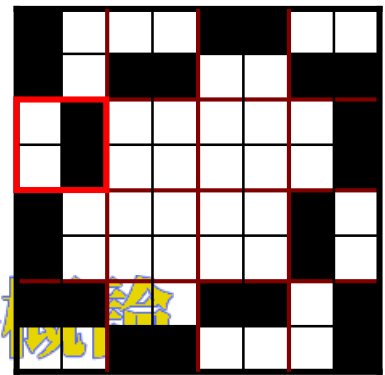

旋轉式視覺密碼

(Wu and Chen, 1998)

p_1	□	□	■	■	□	□	■	■	□	□	■	■	□	□	■	■
p_2	□	■	□	■	□	■	□	■	□	■	□	■	□	■	□	■
s_1	■	■	■	■	■	■	■	■	■	■	■	■	■	■	■	■
s_2	■	■	■	■	■	■	■	■	■	■	■	■	■	■	■	■

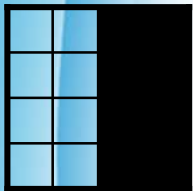

P_1

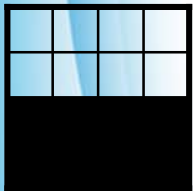
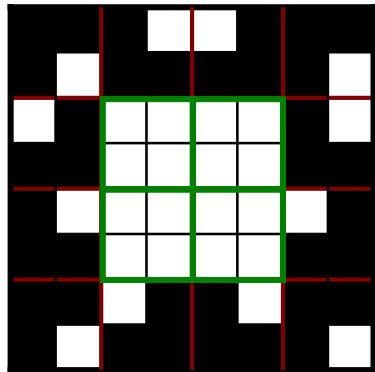

P_2

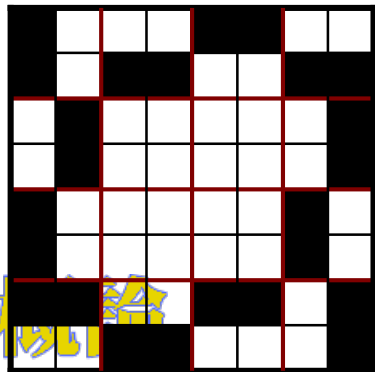

旋轉式視覺密碼

(Wu and Chen, 1998)

p_1	□	□	■	■	□	□	■	■	□	□	■	■	□	□	■	■
p_2	□	■	□	■	□	■	□	■	□	■	□	■	□	■	□	■
s_1	■	■	■	■	■	■	■	■	■	■	■	■	■	■	■	■
s_2	■	■	■	■	■	■	■	■	■	■	■	■	■	■	■	■

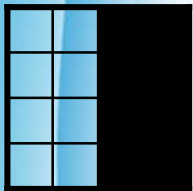

P_1

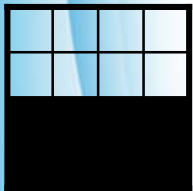
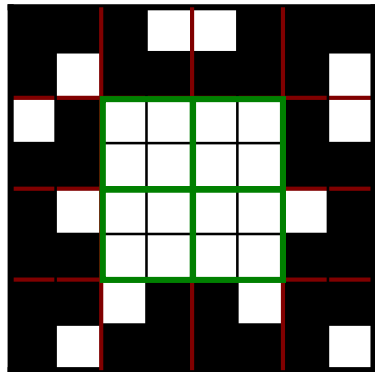

P_2

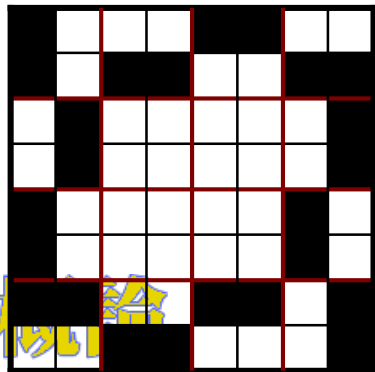

旋轉式視覺密碼

(Wu and Chen, 1998)

p_1	□	□	■	■	□	□	■	■	□	□	■	■	□	□	■	■
p_2	□	■	□	■	□	■	□	■	□	■	□	■	□	■	□	■
s_1	■	■	■	■	■	■	■	■	■	■	■	■	■	■	■	■
s_2	■	■	■	■	■	■	■	■	■	■	■	■	■	■	■	■

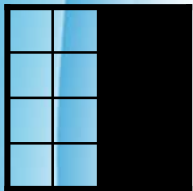

P_1

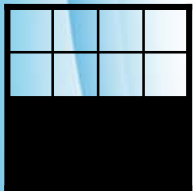
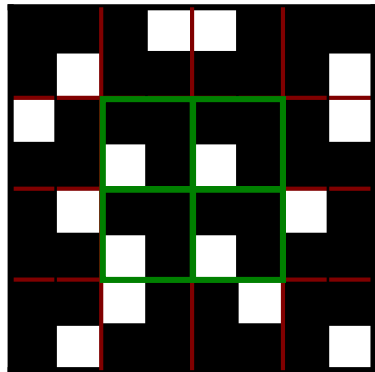

P_2

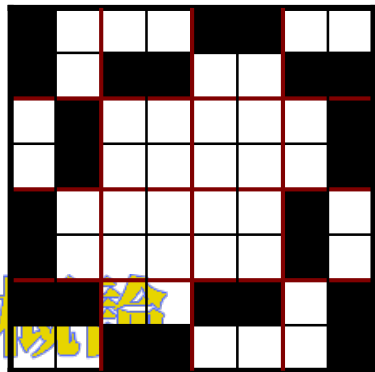

旋轉式視覺密碼

(Wu and Chen, 1998)

p_1	□	□	■	■	□	□	■	■	□	□	■	■	□	□	■	■
p_2	□	■	□	■	□	■	□	■	□	■	□	■	□	■	□	■
s_1	■	■	■	■	■	■	■	■	■	■	■	■	■	■	■	■
s_2	■	■	■	■	■	■	■	■	■	■	■	■	■	■	■	■

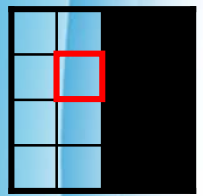

P_1

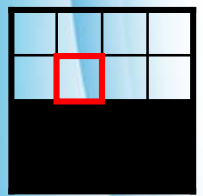
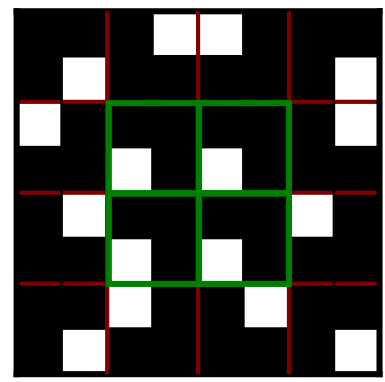

P_2

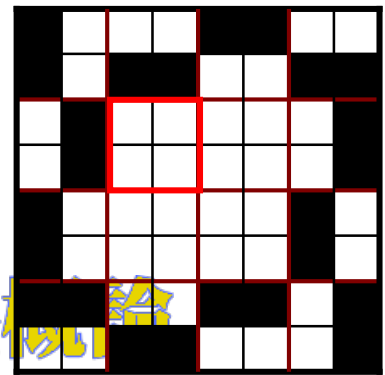

旋轉式視覺密碼

(Wu and Chen, 1998)

p_1	□	□	■	■	□	□	■	■	□	□	■	■	□	□	■	■
p_2	□	■	□	■	□	■	□	■	□	■	□	■	□	■	□	■
s_1	■	■	■	■	■	■	■	■	■	■	■	■	■	■	■	■
s_2	■	■	■	■	■	■	■	■	■	■	■	■	■	■	■	■

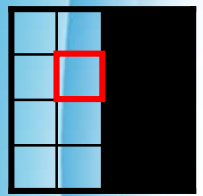

P_1

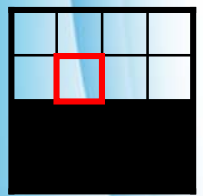
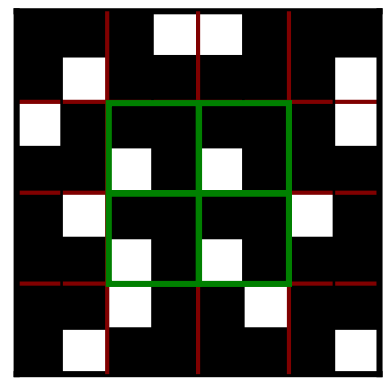

P_2

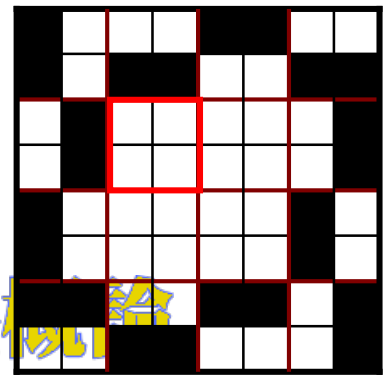

旋轉式視覺密碼

(Wu and Chen, 1998)

p_1	□	□	■	■	□	□	■	■	□	□	■	■	□	□	■	■
p_2	□	■	□	■	□	■	□	■	□	■	□	■	□	■	□	■
s_1	■	■	■	■	■	■	■	■	■	■	■	■	■	■	■	■
s_2	■	■	■	■	■	■	■	■	■	■	■	■	■	■	■	■

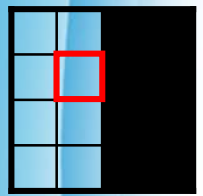

P_1

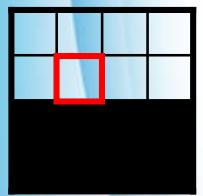
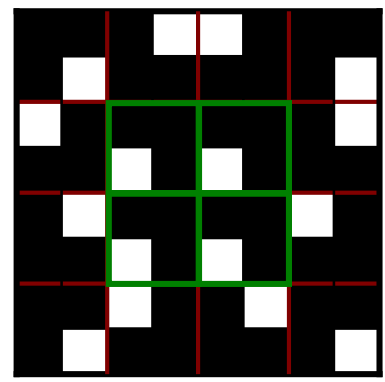

P_2

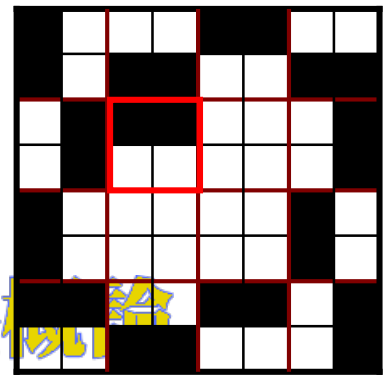

旋轉式視覺密碼

(Wu and Chen, 1998)

p_1	□	□	■	■	□	□	■	■	□	□	■	■	□	□	■	■
p_2	□	■	□	■	□	■	□	■	□	■	□	■	□	■	□	■
s_1	■	■	■	■	■	■	■	■	■	■	■	■	■	■	■	■
s_2	■	■	■	■	■	■	■	■	■	■	■	■	■	■	■	■

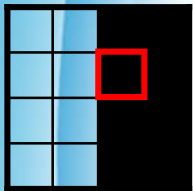

P_1

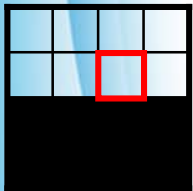
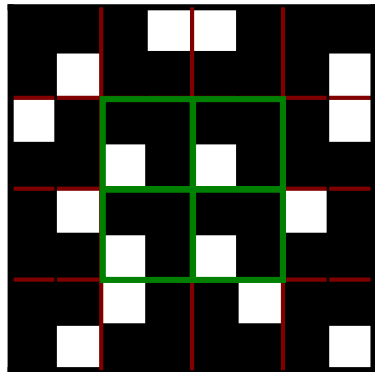

P_2

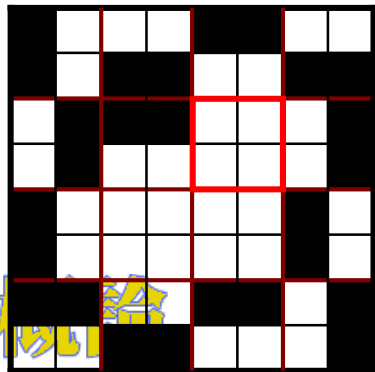

旋轉式視覺密碼

(Wu and Chen, 1998)

p_1	□	□	■	■	□	□	■	■	□	□	■	■	□	□	■	■
p_2	□	■	□	■	□	■	□	■	□	■	□	■	□	■	□	■
s_1	■	■	■	■	■	■	■	■	■	■	■	■	■	■	■	■
s_2	■	■	■	■	■	■	■	■	■	■	■	■	■	■	■	■

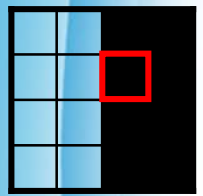

P_1

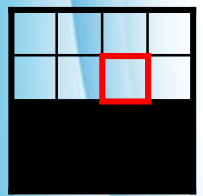
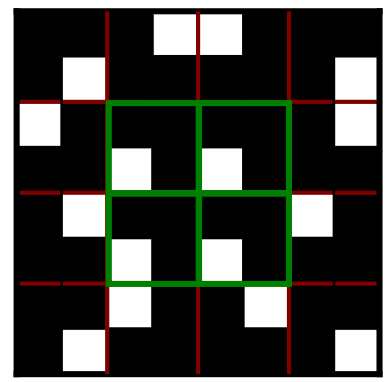

P_2

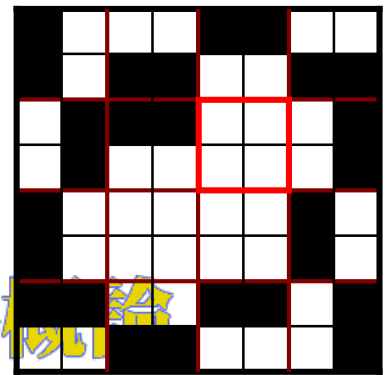

旋轉式視覺密碼

(Wu and Chen, 1998)

p_1	□	□	■	■	□	□	■	■	□	□	■	■	□	□	■	■
p_2	□	■	□	■	□	■	□	■	□	■	□	■	□	■	□	■
s_1	■	■	■	■	■	■	■	■	■	■	■	■	■	■	■	■
s_2	■	■	■	■	■	■	■	■	■	■	■	■	■	■	■	■

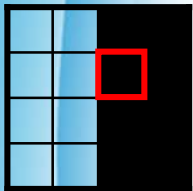

P_1

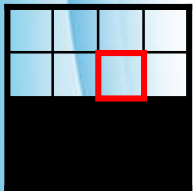
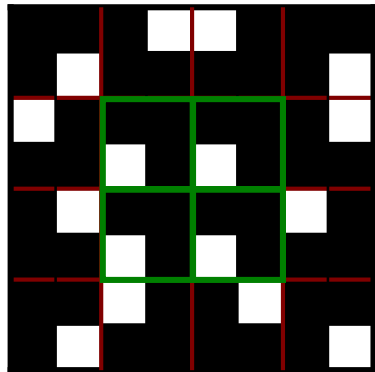

P_2

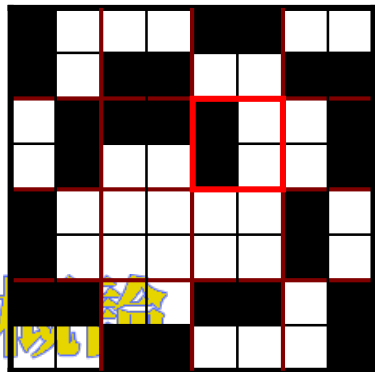

旋轉式視覺密碼

(Wu and Chen, 1998)

p_1	□	□	■	■	□	□	■	■	□	□	■	■	□	□	■	■
p_2	□	■	□	■	□	■	□	■	□	■	□	■	□	■	□	■
s_1	■	■	■	■	■	■	■	■	■	■	■	■	■	■	■	■
s_2	■	■	■	■	■	■	■	■	■	■	■	■	■	■	■	■

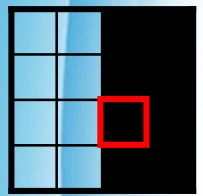

P_1

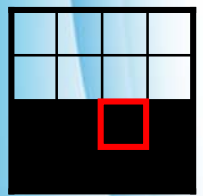
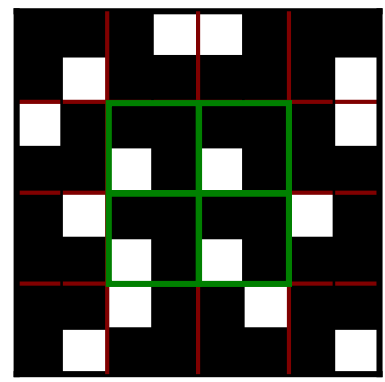

P_2

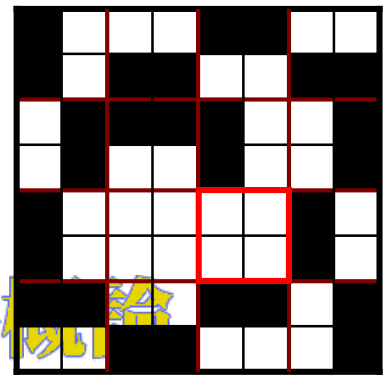

旋轉式視覺密碼

(Wu and Chen, 1998)

p_1	□	□	■	■	□	□	■	■	□	□	■	■	□	□	■	■
p_2	□	■	□	■	□	■	□	■	□	■	□	■	□	■	□	■
s_1	■	■	■	■	■	■	■	■	■	■	■	■	■	■	■	■
s_2	■	■	■	■	■	■	■	■	■	■	■	■	■	■	■	■

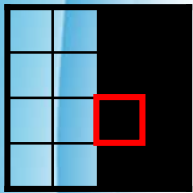

P_1

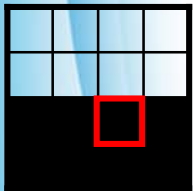
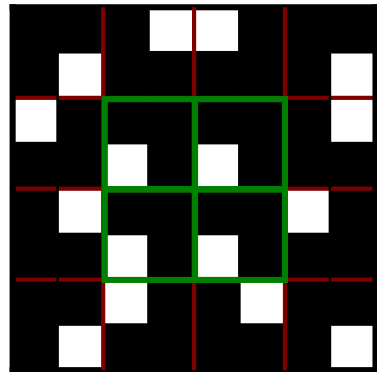

P_2

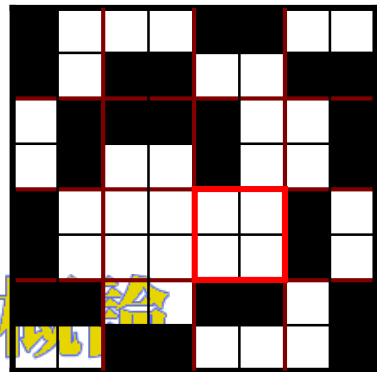

計算機概論



旋轉式視覺密碼

(Wu and Chen, 1998)

p_1	□	□	■	■	□	□	■	■	□	□	■	■	□	□	■	■
p_2	□	■	□	■	□	■	□	■	□	■	□	■	□	■	□	■
s_1	■	■	■	■	■	■	■	■	■	■	■	■	■	■	■	■
s_2	■	■	■	■	■	■	■	■	■	■	■	■	■	■	■	■

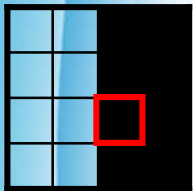

P_1

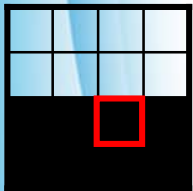
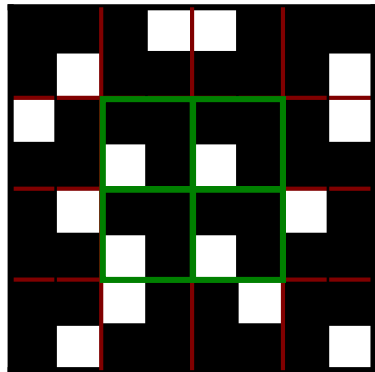

P_2

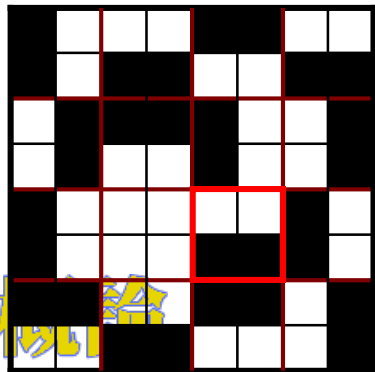

計算機概論



旋轉式視覺密碼

(Wu and Chen, 1998)

p_1	□	□	■	■	□	□	■	■	□	□	■	■	□	□	■	■
p_2	□	■	□	■	□	■	□	■	□	■	□	■	□	■	□	■
s_1	■	■	■	■	■	■	■	■	■	■	■	■	■	■	■	■
s_2	■	■	■	■	■	■	■	■	■	■	■	■	■	■	■	■

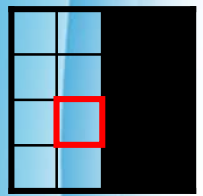

P_1

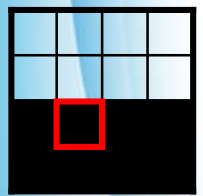
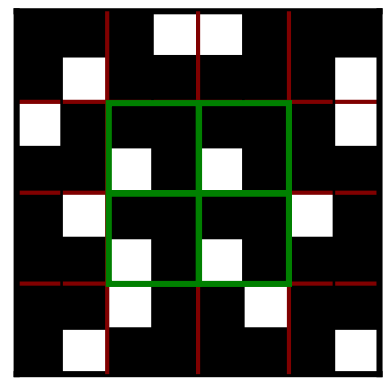

P_2

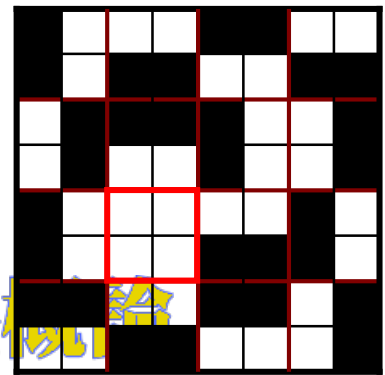

旋轉式視覺密碼

(Wu and Chen, 1998)

p_1	□	□	■	■	□	□	■	■	□	□	■	■	□	□	■	■
p_2	□	■	□	■	□	■	□	■	□	■	□	■	□	■	□	■
s_1	■	■	■	■	■	■	■	■	■	■	■	■	■	■	■	■
s_2	■	■	■	■	■	■	■	■	■	■	■	■	■	■	■	■

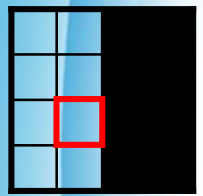

P_1

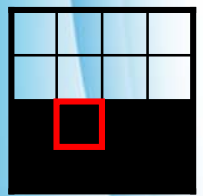
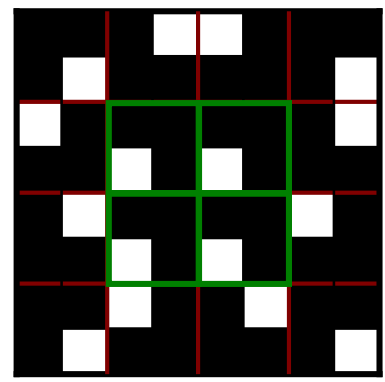

P_2

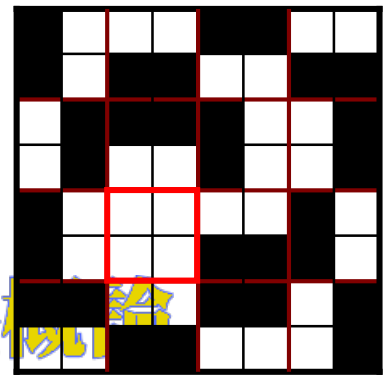

旋轉式視覺密碼

(Wu and Chen, 1998)

p_1	□	□	■	■	□	□	■	■	□	□	■	■	□	□	■	■
p_2	□	■	□	■	□	■	□	■	□	■	□	■	□	■	□	■
s_1	■	■	■	■	■	■	■	■	■	■	■	■	■	■	■	■
s_2	■	■	■	■	■	■	■	■	■	■	■	■	■	■	■	■

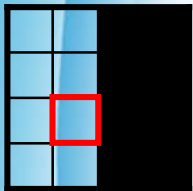

P_1

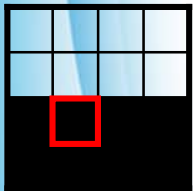
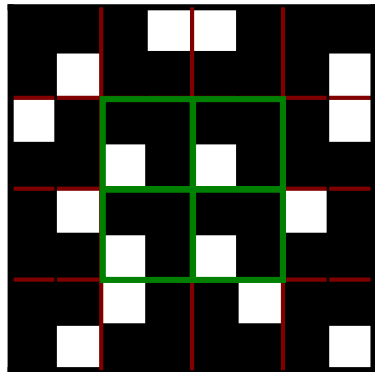

P_2

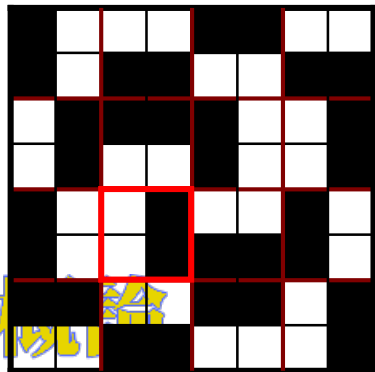

計算機概論



旋轉式視覺密碼

(Wu and Chen, 1998)

p_1	□	□	■	■	□	□	■	■	□	□	■	■	□	□	■	■
p_2	□	■	□	■	□	■	□	■	□	■	□	■	□	■	□	■
s_1	■	■	■	■	■	■	■	■	■	■	■	■	■	■	■	■
s_2	■	■	■	■	■	■	■	■	■	■	■	■	■	■	■	■

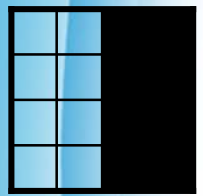

P_1

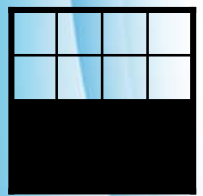
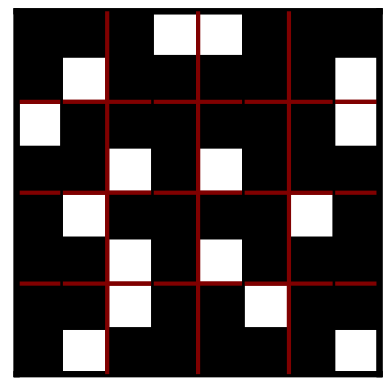

P_2

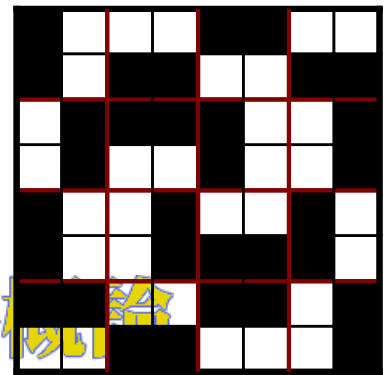

旋轉式視覺密碼

(Wu and Chen, 1998)

p_1	□	□	■	■	□	□	■	■	□	□	■	■	□	□	■	■
p_2	□	■	□	■	□	■	□	■	□	■	□	■	□	■	□	■
s_1	■	■	■	■	■	■	■	■	■	■	■	■	■	■	■	■
s_2	■	■	■	■	■	■	■	■	■	■	■	■	■	■	■	■



P_1

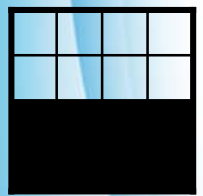
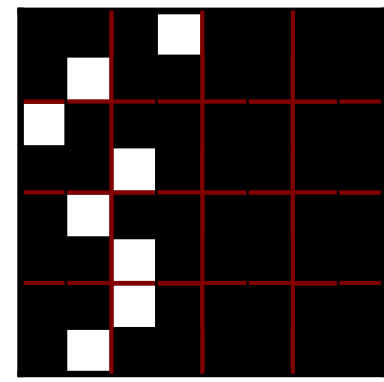
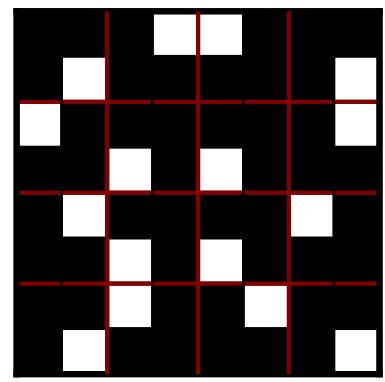

P_2

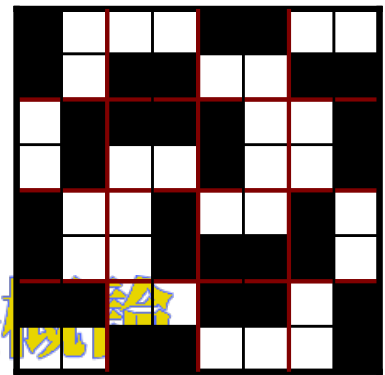

旋轉式視覺密碼

(Wu and Chen, 1998)

p_1	□	□	■	■	□	□	■	■	□	□	■	■	□	□	■	■
p_2	□	■	□	■	□	■	□	■	□	■	□	■	□	■	□	■
s_1	■	■	■	■	■	■	■	■	■	■	■	■	■	■	■	■
s_2	■	■	■	■	■	■	■	■	■	■	■	■	■	■	■	■

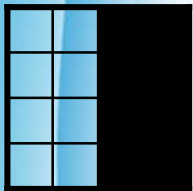

P_1

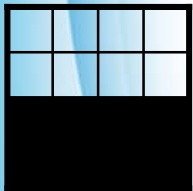
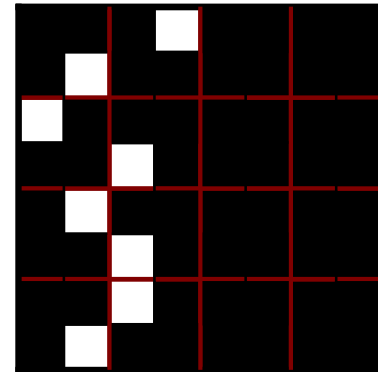
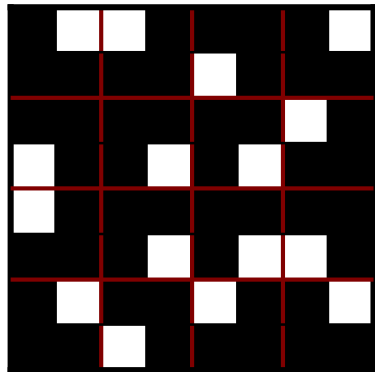

P_2

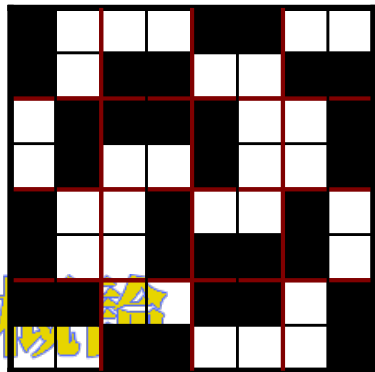

旋轉式視覺密碼

(Wu and Chen, 1998)

p_1	□	□	■	■	□	□	■	■	□	□	■	■	□	□	■	■
p_2	□	■	□	■	□	■	□	■	□	■	□	■	□	■	□	■
s_1	■	■	■	■	■	■	■	■	■	■	■	■	■	■	■	■
s_2	■	■	■	■	■	■	■	■	■	■	■	■	■	■	■	■

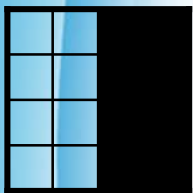

P_1

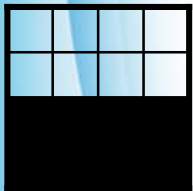

P_2

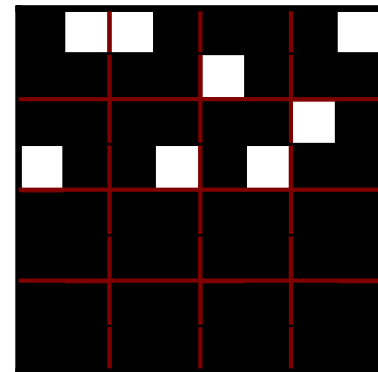
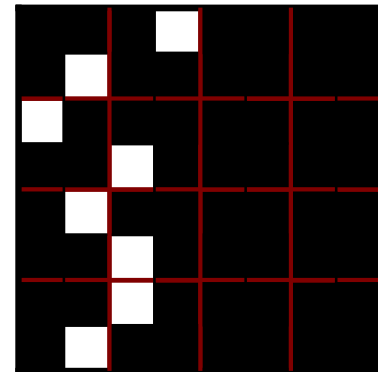

作業二 – 第一階段

- 請利用視覺密碼的編碼技巧，實作出兩張投影片，當兩張投影片疊合後可看到一張機密影像。
- 請使用線上編碼器
 - <http://goo.gl/2li1CO>
- 製作完請將原圖、投影片一、投影片二和疊合結果下載圖片，**壓縮檔名為 學號-姓名-HW2.zip (or rar)**。
 - 收件人：kchen@csie.org
 - 主旨：**[bcc14spr][hw][2] 學號-姓名**



作業二 – 第二階段

- 6月4日 將會發投影片實體，並且會在資工系 432室 張貼分享影像海報。
- 請利用發放的投影片與分享影像海報疊合，取得作業二認證碼。
- 並於 6月11日 之前至指定網站填寫認證碼，取得作業二成績。



愛情樹

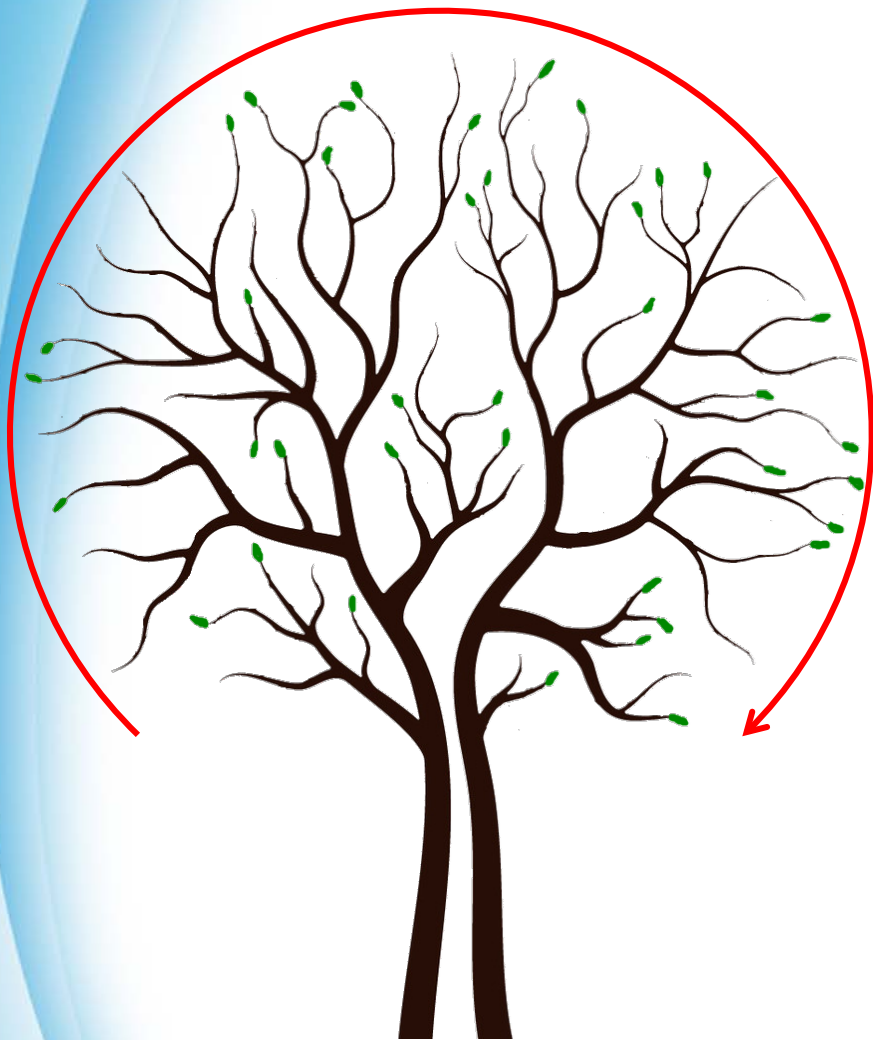

金鑰：
有葉為壹，無葉為零，
順時旋轉，ASCII。

01101001 i

01101100 l

01101111 o

01110110 v

01100101 e

01111001 y

01101111 o

01110101 u



Reference

- [1] M. Naor, A. Shamir, Visual Cryptography, *Advances in Cryptology: Eurpocrypt'94*, LNCS 950, 1-12, 1995.
- [2] C.C. Wu and L.H. Chen, A Study on Visual Cryptography, *Master thesis*, Institute of Computer and Information Science, National Chiao Tung University, Taiwan, R.O.C, 1998.
- [3] H.-C. Wu and C.-C. Chang, Sharing visual multi-secrets using circle shares, *Computer Standards & Interfaces*, 134(28), 123-135, 2005.
- [4] A. H. C. Wu, H. C. Wang and C. S. Tsai, Multiple image sharing based on colour visual cryptography, *The Imaging Science Journal*, 54(3), 164-177, 2006.
- [5] S. J. Shyu, S.-Y. Huang, Y.-K. Lee, R.-Z. Wang, K. Chen, Sharing multiple secrets in visual cryptography, *Pattern Recognition*, 40, 3633-3651, 2007
- [6] B. J. B. Feng, H. C. Wu, C. S. Tsai, Y. F. Chang and Y. P. Chu, Visual secret sharing for multiple secrets, *Pattern Recognition*, 41, 3572-3581, 2008.
- [7] J.Chen, T.S. Chen, H. C. Hsu, Y. H. Lin, Using multi-ringed shadow image of visual cryptography to hide more secret messages, *The Image Science Journal*, 57, 101-108, 2009
- [8] S. J. Shyu, K. Chen, Visual multiple secrets sharing by circle random grids, to appear in *SIAM Journal on Imaging Sciences*, 2010.

