

Motion estimation

Digital Visual Effects

Yung-Yu Chuang

with slides by Michael Black and P. Anandan

Motion estimation

- Parametric motion (image alignment)
- Tracking
- Optical flow

Parametric motion

direct method for image stitching

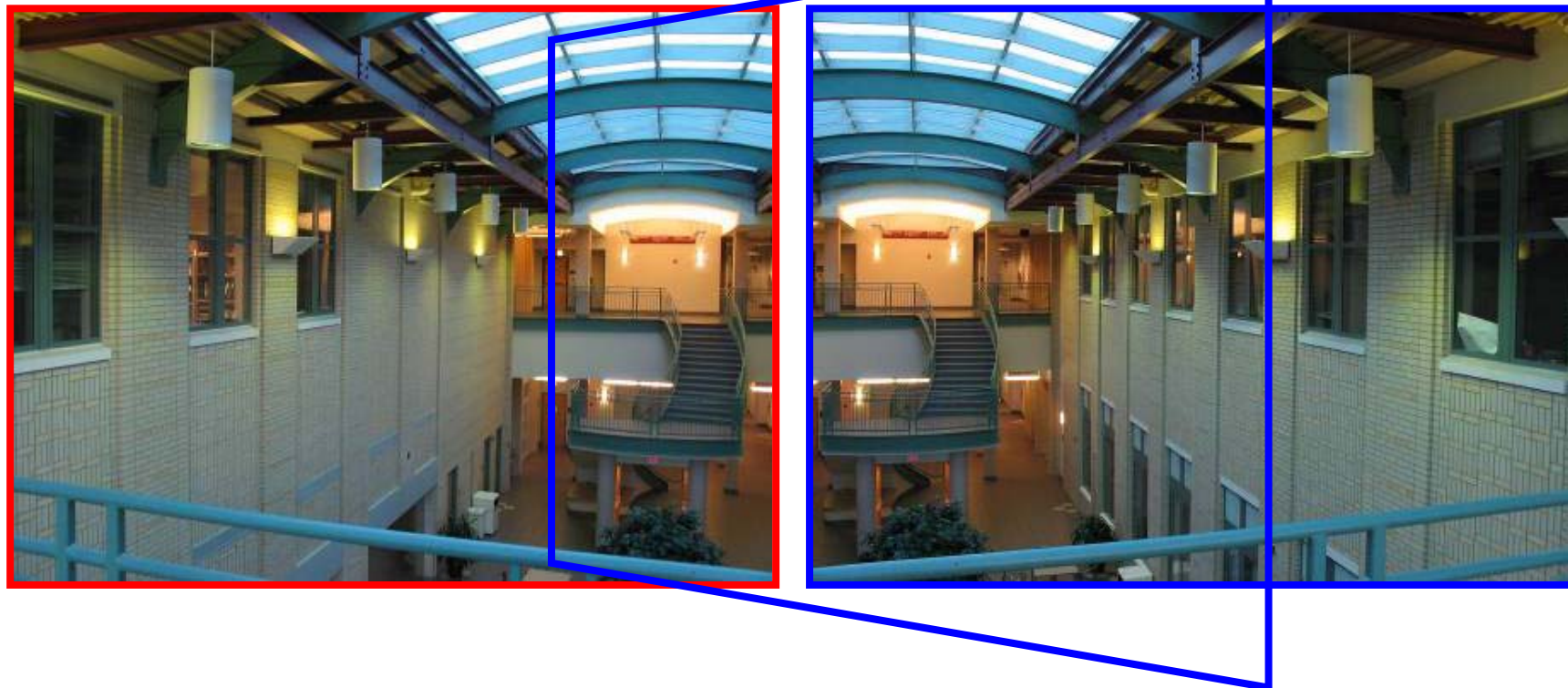

Tracking

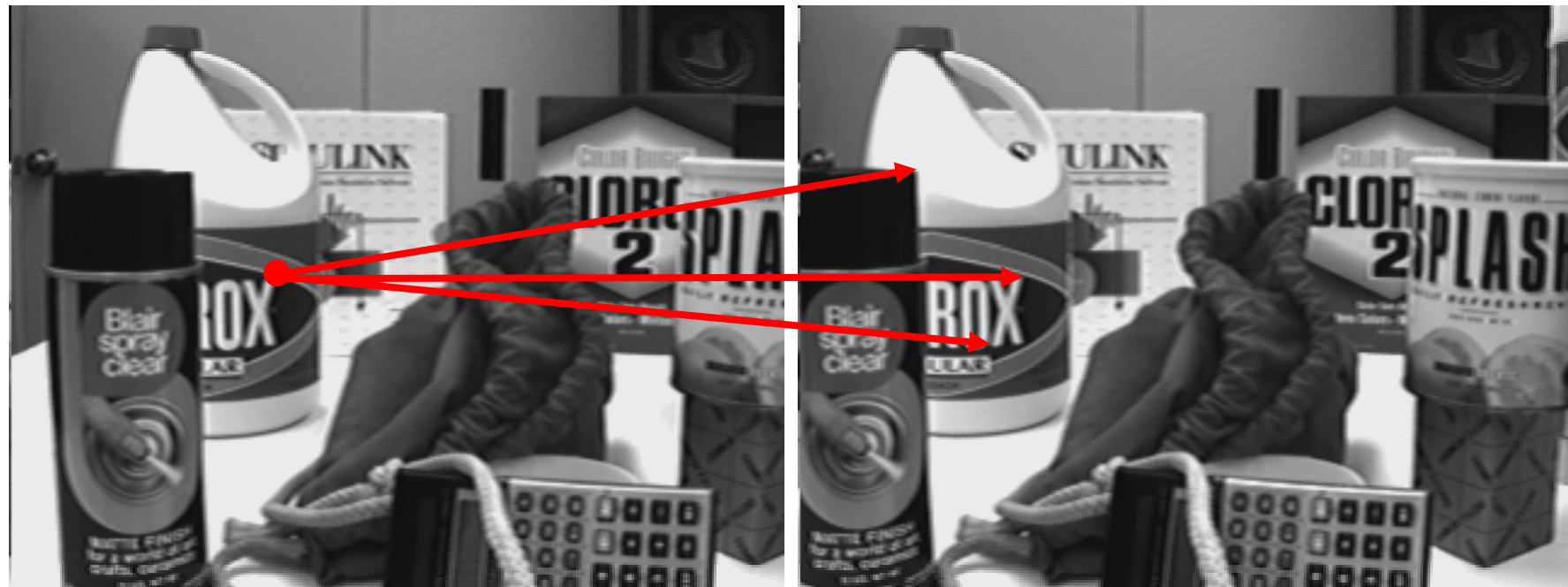

Optical flow

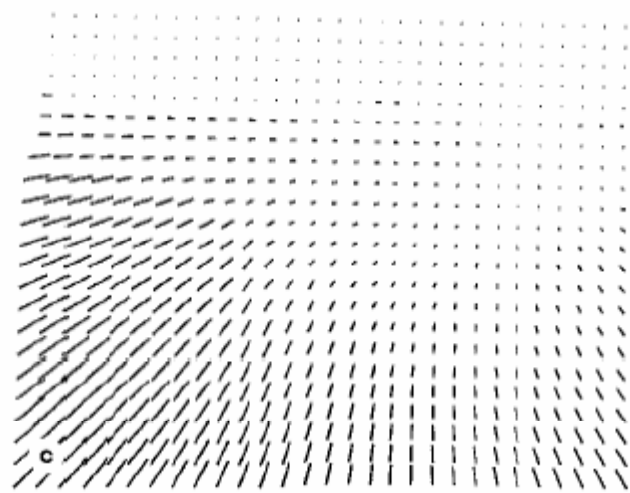
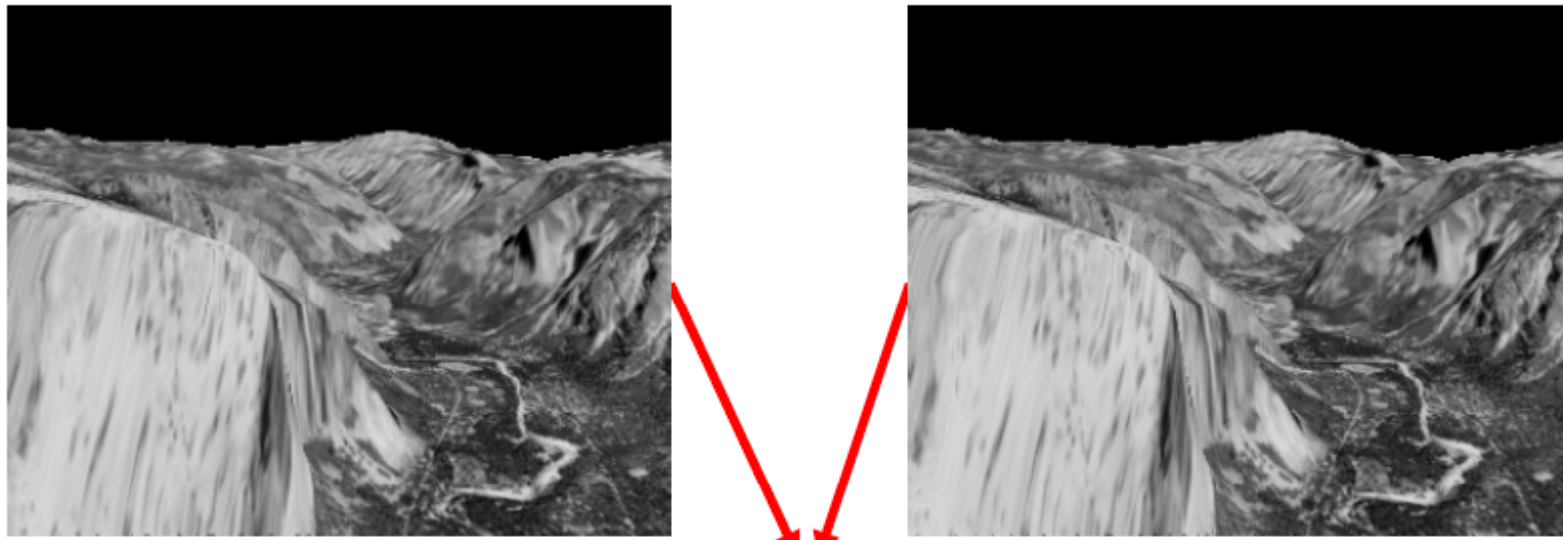

Three assumptions

- Brightness consistency
- Spatial coherence
- Temporal persistence

Brightness consistency

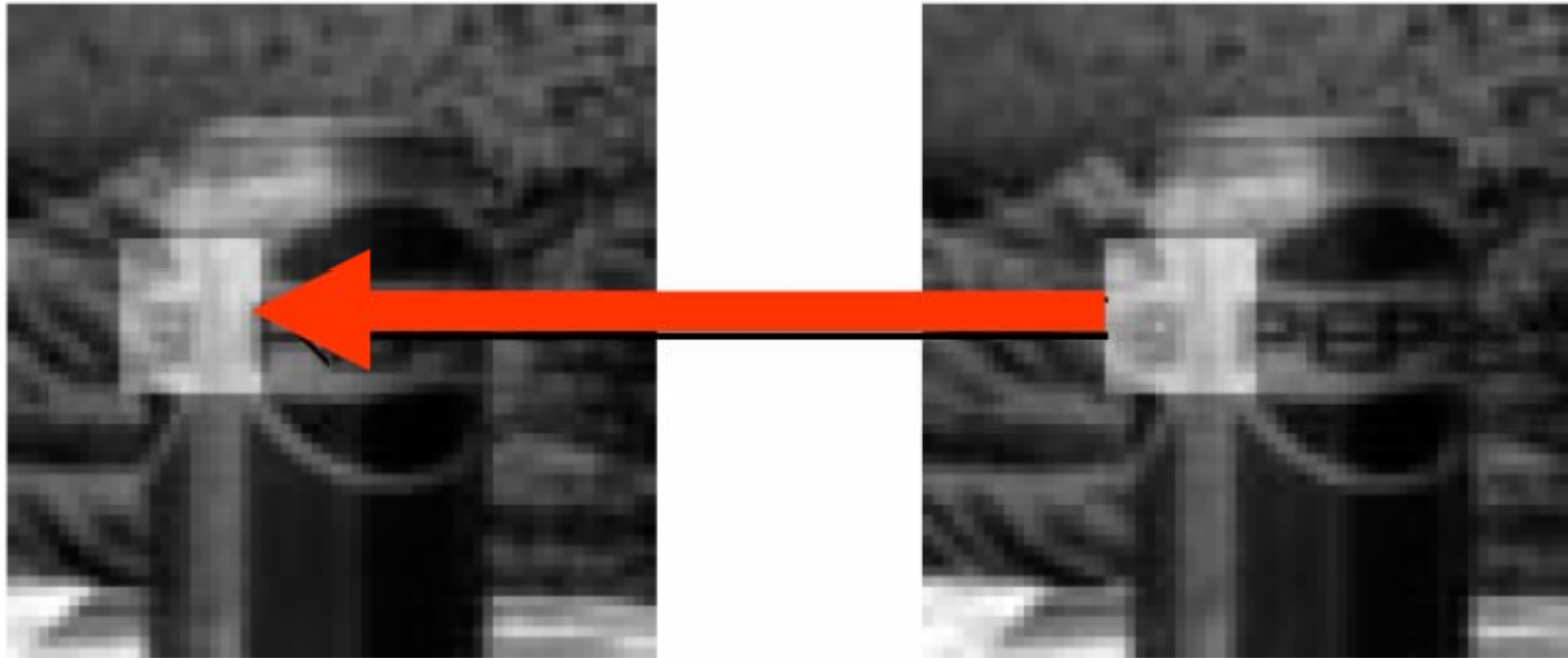
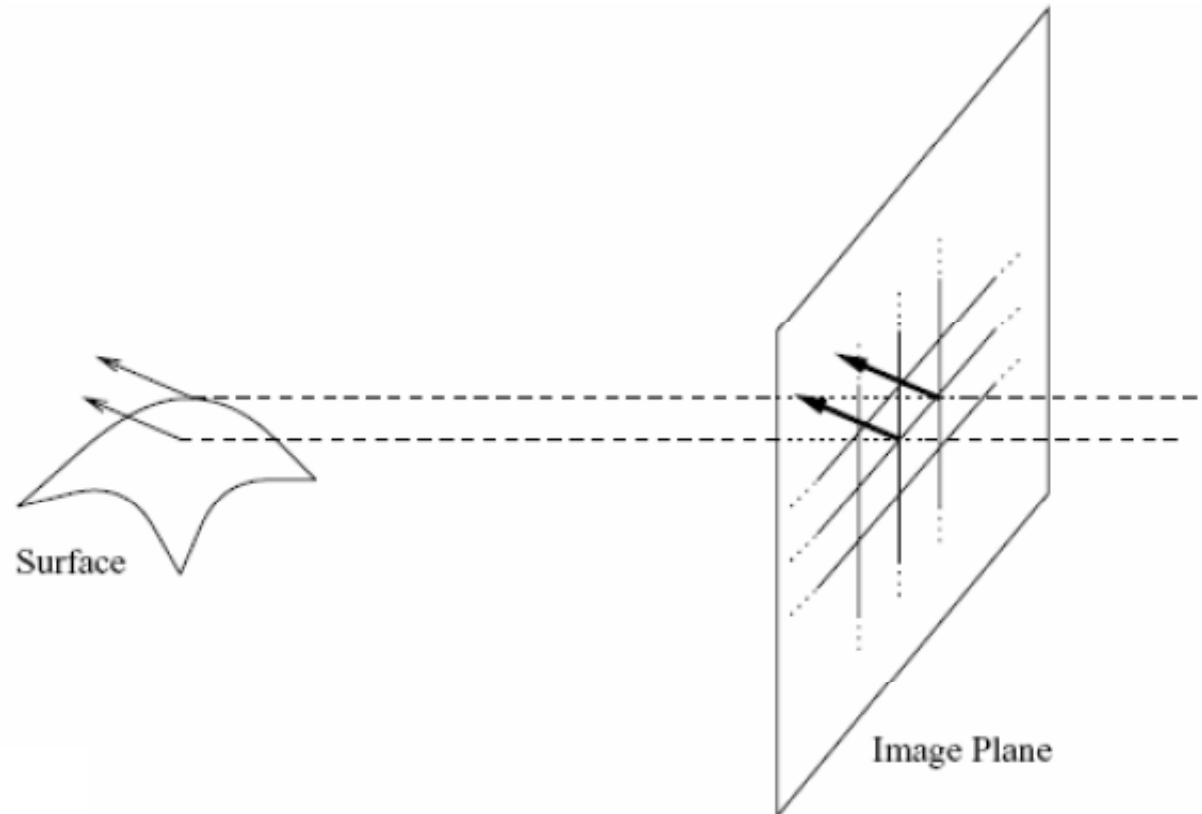

Image measurement (e.g. brightness) in a small region remain the same although their location may change.

Spatial coherence



- Neighboring points in the scene typically belong to the same surface and hence typically have similar motions.
- Since they also project to nearby pixels in the image, we expect spatial coherence in image flow.

Temporal persistence

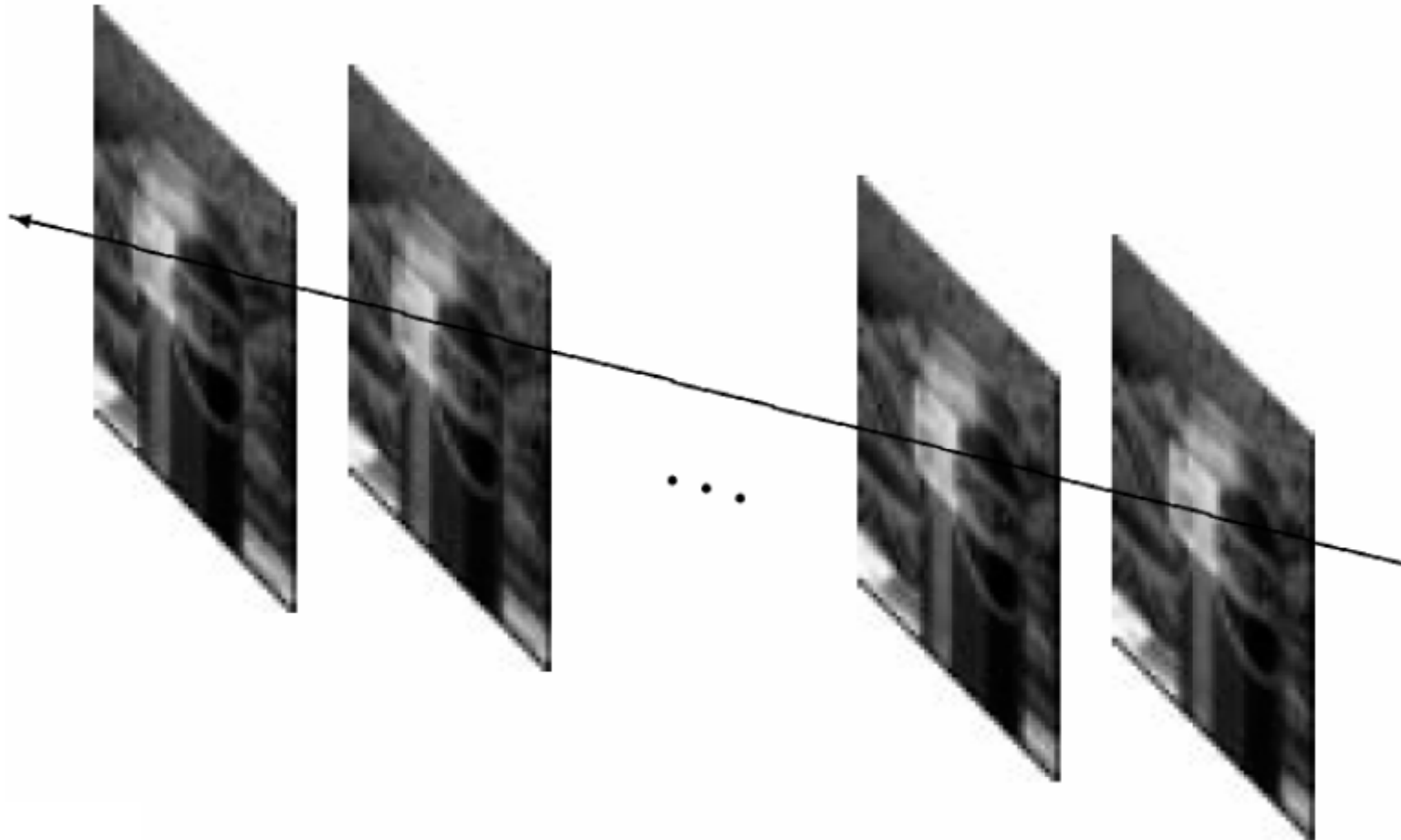

The image motion of a surface patch changes gradually over time.

Image registration

Goal: register a template image $T(x)$ and an input image $I(x)$, where $x=(x,y)^T$. (warp I so that it matches T)

Image alignment: $I(x)$ and $T(x)$ are two images

Tracking: $T(x)$ is a small patch around a point p in the image at t . $I(x)$ is the image at time $t+1$.

Optical flow: $T(x)$ and $I(x)$ are patches of images at t and $t+1$.

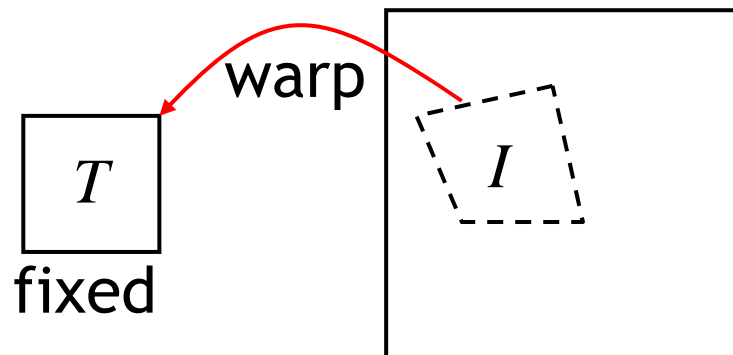

Simple approach (for translation)

- Minimize brightness difference

$$E(u, v) = \sum_{x, y} (I(x + u, y + v) - T(x, y))^2$$

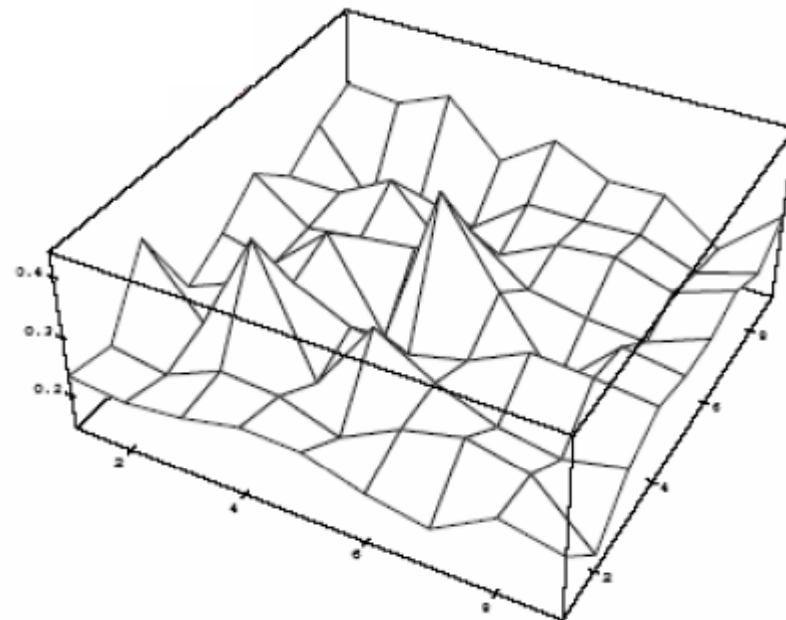
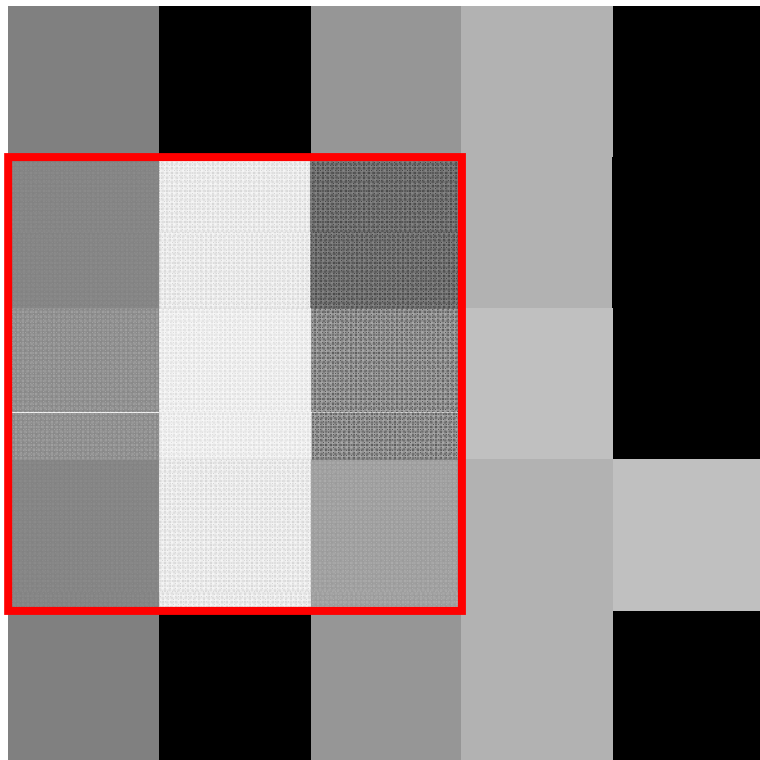

Simple SSD algorithm

For each offset (u, v)

 compute $E(u, v)$;

Choose (u, v) which minimizes $E(u, v)$;

Problems:

- Not efficient
- No sub-pixel accuracy

Lucas-Kanade algorithm

Newton's method

- Root finding for $f(x)=0$
- March x and test signs
- Determine Δx (small \rightarrow slow; large \rightarrow miss)

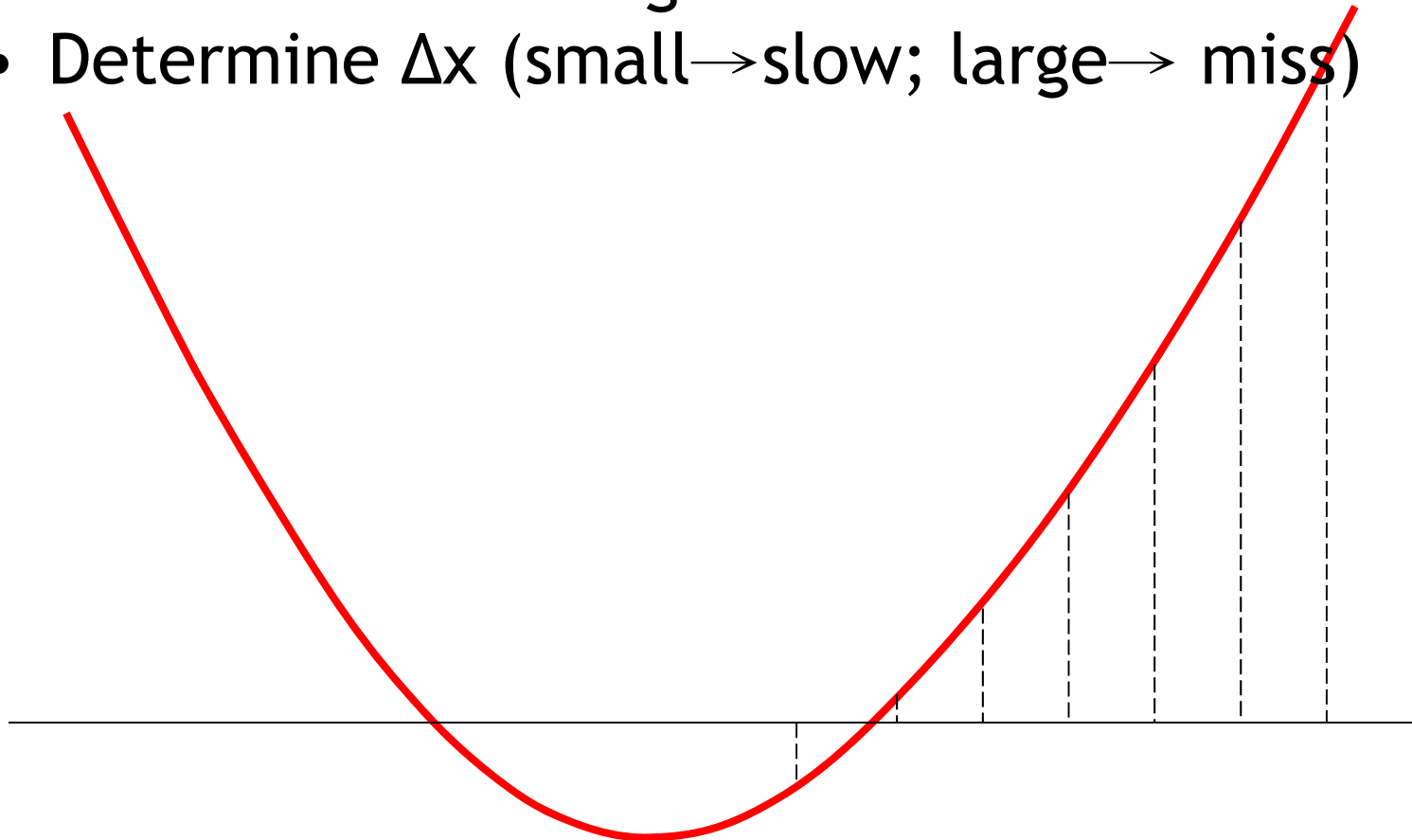

Newton's method

- Root finding for $f(x)=0$

Newton's method

- Root finding for $f(x)=0$

Taylor's expansion:

$$f(x_0 + \varepsilon) = f(x_0) + f'(x_0)\varepsilon + \frac{1}{2}f''(x_0)\varepsilon^2 + \dots$$

$$f(x_0 + \varepsilon) \approx f(x_0) + f'(x_0)\varepsilon$$

$$\varepsilon_n = -\frac{f(x_n)}{f'(x_n)}$$

$$x_{n+1} = x_n - \frac{f(x_n)}{f'(x_n)}$$

Newton's method

- Root finding for $f(x)=0$

$$\varepsilon_n = -\frac{f(x_n)}{f'(x_n)}$$

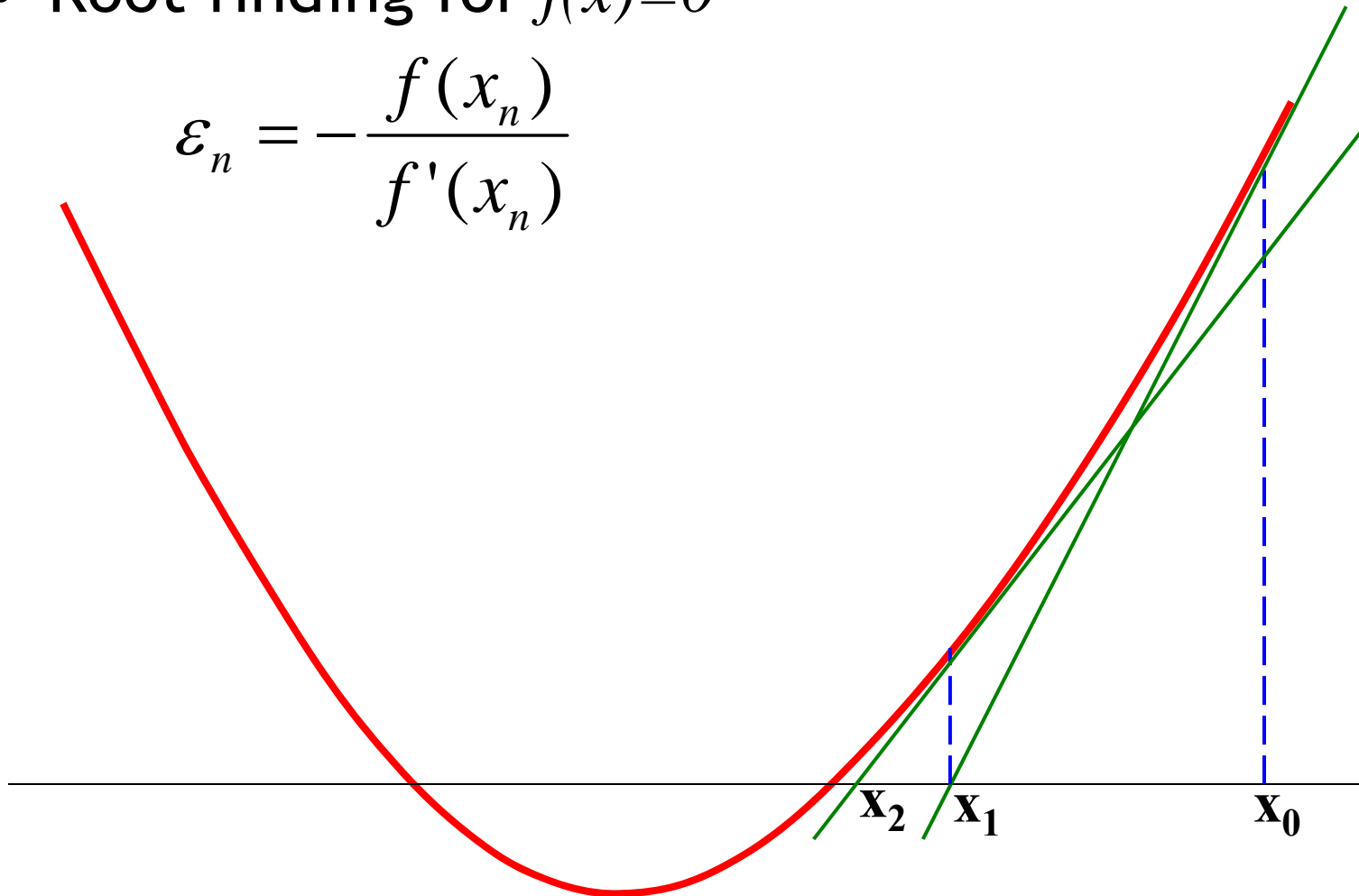

Newton's method

pick up $\mathbf{x}=\mathbf{x}_0$

iterate

compute $\Delta\mathbf{x} = -\frac{f(\mathbf{x})}{f'(\mathbf{x})}$

update \mathbf{x} by $\mathbf{x}+\Delta\mathbf{x}$

until converge

Finding root is useful for optimization because

Minimize $g(x) \rightarrow$ find root for $f(x)=g'(x)=0$

Lucas-Kanade algorithm

$$E(u, v) = \sum_{x, y} (I(x+u, y+v) - T(x, y))^2$$

$$I(x+u, y+v) \approx I(x, y) + uI_x + vI_y$$

$$= \sum_{x, y} (I(x, y) - T(x, y) + uI_x + vI_y)^2$$

$$0 = \frac{\partial E}{\partial u} = \sum_{x, y} 2I_x (I(x, y) - T(x, y) + uI_x + vI_y)$$

$$0 = \frac{\partial E}{\partial v} = \sum_{x, y} 2I_y (I(x, y) - T(x, y) + uI_x + vI_y)$$

Lucas-Kanade algorithm

$$0 = \frac{\partial E}{\partial u} = \sum_{x,y} 2I_x (I(x,y) - T(x,y) + uI_x + vI_y)$$

$$0 = \frac{\partial E}{\partial v} = \sum_{x,y} 2I_y (I(x,y) - T(x,y) + uI_x + vI_y)$$

$$\Rightarrow \begin{cases} \sum_{x,y} I_x^2 u + \sum_{x,y} I_x I_y v = \sum_{x,y} I_x (T(x,y) - I(x,y)) \\ \sum_{x,y} I_x I_y u + \sum_{x,y} I_y^2 v = \sum_{x,y} I_y (T(x,y) - I(x,y)) \end{cases}$$

$$\Rightarrow \begin{bmatrix} \sum_{x,y} I_x^2 & \sum_{x,y} I_x I_y \\ \sum_{x,y} I_x I_y & \sum_{x,y} I_y^2 \end{bmatrix} \begin{bmatrix} u \\ v \end{bmatrix} = \begin{bmatrix} \sum_{x,y} I_x (T(x,y) - I(x,y)) \\ \sum_{x,y} I_y (T(x,y) - I(x,y)) \end{bmatrix}$$

Lucas-Kanade algorithm

iterate

shift $I(x,y)$ with (u,v)

compute gradient image I_x, I_y

compute error image $T(x,y)-I(x,y)$

compute Hessian matrix

solve the linear system



$(u,v)=(u,v)+(\Delta u,\Delta v)$

until converge

$$\begin{bmatrix} \sum_{x,y} I_x^2 & \sum_{x,y} I_x I_y \\ \sum_{x,y} I_x I_y & \sum_{x,y} I_y^2 \end{bmatrix} \begin{bmatrix} u \\ v \end{bmatrix} = \begin{bmatrix} \sum_{x,y} I_x (T(x,y) - I(x,y)) \\ \sum_{x,y} I_y (T(x,y) - I(x,y)) \end{bmatrix}$$

Parametric model

$$E(u, v) = \sum_{x, y} (I(x + u, y + v) - T(x, y))^2$$

 $E(\mathbf{p}) = \sum_{\mathbf{x}} (I(\mathbf{W}(\mathbf{x}; \mathbf{p})) - T(\mathbf{x}))^2$

 Our goal is to find \mathbf{p} to minimize $\mathbf{E}(\mathbf{p})$

for all \mathbf{x} in T 's domain

translation $\mathbf{W}(\mathbf{x}; \mathbf{p}) = \begin{pmatrix} x + d_x \\ y + d_y \end{pmatrix}, p = (d_x, d_y)^T$

affine $\mathbf{W}(\mathbf{x}; \mathbf{p}) = \mathbf{A}\mathbf{x} + \mathbf{d} = \begin{pmatrix} 1 + d_{xx} & d_{xy} & d_x \\ d_{yx} & 1 + d_{yy} & d_y \end{pmatrix} \begin{pmatrix} x \\ y \\ 1 \end{pmatrix},$

$$p = (d_{xx}, d_{xy}, d_{yx}, d_{yy}, d_x, d_y)^T$$

Parametric model

$$\text{minimize } \sum_{\mathbf{x}} (I(\mathbf{W}(\mathbf{x}; \mathbf{p} + \Delta \mathbf{p})) - T(\mathbf{x}))^2$$

with respect to $\Delta \mathbf{p}$

$$\mathbf{W}(\mathbf{x}; \mathbf{p} + \Delta \mathbf{p}) \approx \mathbf{W}(\mathbf{x}; \mathbf{p}) + \frac{\partial \mathbf{W}}{\partial \mathbf{p}} \Delta \mathbf{p}$$

$$I(\mathbf{W}(\mathbf{x}; \mathbf{p} + \Delta \mathbf{p})) \approx I(\mathbf{W}(\mathbf{x}; \mathbf{p}) + \frac{\partial \mathbf{W}}{\partial \mathbf{p}} \Delta \mathbf{p})$$

$$\approx I(\mathbf{W}(\mathbf{x}; \mathbf{p})) + \frac{\partial I}{\partial \mathbf{x}} \frac{\partial \mathbf{W}}{\partial \mathbf{p}} \Delta \mathbf{p}$$

$$\longrightarrow \text{minimize } \sum_{\mathbf{x}} \left(I(\mathbf{W}(\mathbf{x}; \mathbf{p})) + \nabla I \frac{\partial \mathbf{W}}{\partial \mathbf{p}} \Delta \mathbf{p} - T(\mathbf{x}) \right)^2$$

Parametric model

warped image

target image

image gradient

$$\sum_{\mathbf{x}} \left(I(\mathbf{W}(\mathbf{x}; \mathbf{p})) + \nabla I \frac{\partial \mathbf{W}}{\partial \mathbf{p}} \Delta \mathbf{p} - T(\mathbf{x}) \right)^2$$

Jacobian of the warp

$$\frac{\partial \mathbf{W}}{\partial \mathbf{p}} = \begin{pmatrix} \frac{\partial \mathbf{W}_x}{\partial \mathbf{p}} \\ \frac{\partial \mathbf{W}_y}{\partial \mathbf{p}} \end{pmatrix} = \begin{pmatrix} \frac{\partial \mathbf{W}_x}{\partial \mathbf{p}_1} & \frac{\partial \mathbf{W}_x}{\partial \mathbf{p}_2} & \dots & \frac{\partial \mathbf{W}_x}{\partial \mathbf{p}_n} \\ \frac{\partial \mathbf{W}_y}{\partial \mathbf{p}_1} & \frac{\partial \mathbf{W}_y}{\partial \mathbf{p}_2} & \dots & \frac{\partial \mathbf{W}_y}{\partial \mathbf{p}_n} \end{pmatrix}$$

Jacobian matrix

- The Jacobian matrix is the matrix of all first-order partial derivatives of a vector-valued function.

$$F(x_1, x_2, \dots, x_n) \quad F: \mathbf{R}^n \rightarrow \mathbf{R}^m$$

$$= (f_1(x_1, x_2, \dots, x_n), f_2(x_1, x_2, \dots, x_n), \dots, f_m(x_1, x_2, \dots, x_n))$$

$$J_F(x_1, x_2, \dots, x_n) \quad \text{or} \quad = \begin{bmatrix} \frac{\partial f_1}{\partial x_1} & \dots & \frac{\partial f_1}{\partial x_n} \\ \vdots & \ddots & \vdots \\ \frac{\partial f_m}{\partial x_1} & \dots & \frac{\partial f_m}{\partial x_n} \end{bmatrix}$$

$$\frac{\partial(f_1, f_2, \dots, f_m)}{\partial(x_1, x_2, \dots, x_n)}$$

$$F(\mathbf{x} + \Delta\mathbf{x}) \approx F(\mathbf{x}) + J_F(\mathbf{x})\Delta\mathbf{x}$$

Jacobian matrix

$$F : \mathbf{R} \times [0, \pi] \times [0, 2\pi] \rightarrow \mathbf{R}^3$$

$$t = r \sin \phi \cos \theta$$

$$F(r, \phi, \theta) = (t, u, v)$$

$$u = r \sin \phi \sin \theta$$

$$J_F(r, \phi, \theta) = \begin{bmatrix} \frac{\partial t}{\partial r} & \frac{\partial t}{\partial \phi} & \frac{\partial t}{\partial \theta} \\ \frac{\partial u}{\partial r} & \frac{\partial u}{\partial \phi} & \frac{\partial u}{\partial \theta} \\ \frac{\partial v}{\partial r} & \frac{\partial v}{\partial \phi} & \frac{\partial v}{\partial \theta} \end{bmatrix}$$

$$v = r \cos \phi$$

$$= \begin{bmatrix} \sin \phi \cos \theta & r \cos \phi \cos \theta & -r \sin \phi \sin \theta \\ \sin \phi \sin \theta & r \cos \phi \sin \theta & r \sin \phi \cos \theta \\ \cos \phi & -r \sin \phi & 0 \end{bmatrix}$$

Parametric model

warped image

target image

image gradient

$$\sum_{\mathbf{x}} \left(I(\mathbf{W}(\mathbf{x}; \mathbf{p})) + \nabla I \frac{\partial \mathbf{W}}{\partial \mathbf{p}} \Delta \mathbf{p} - T(\mathbf{x}) \right)^2$$

Jacobian of the warp

$$\frac{\partial \mathbf{W}}{\partial \mathbf{p}} = \begin{pmatrix} \frac{\partial \mathbf{W}_x}{\partial \mathbf{p}} \\ \frac{\partial \mathbf{W}_y}{\partial \mathbf{p}} \end{pmatrix} = \begin{pmatrix} \frac{\partial \mathbf{W}_x}{\partial \mathbf{p}_1} & \frac{\partial \mathbf{W}_x}{\partial \mathbf{p}_2} & \dots & \frac{\partial \mathbf{W}_x}{\partial \mathbf{p}_n} \\ \frac{\partial \mathbf{W}_y}{\partial \mathbf{p}_1} & \frac{\partial \mathbf{W}_y}{\partial \mathbf{p}_2} & \dots & \frac{\partial \mathbf{W}_y}{\partial \mathbf{p}_n} \end{pmatrix}$$

Jacobian of the warp

$$\frac{\partial \mathbf{W}}{\partial \mathbf{p}} = \begin{pmatrix} \frac{\partial \mathbf{W}_x}{\partial \mathbf{p}} \\ \frac{\partial \mathbf{W}_y}{\partial \mathbf{p}} \end{pmatrix} = \begin{pmatrix} \frac{\partial \mathbf{W}_x}{\partial \mathbf{p}_1} & \frac{\partial \mathbf{W}_x}{\partial \mathbf{p}_2} & \dots & \frac{\partial \mathbf{W}_x}{\partial \mathbf{p}_n} \\ \frac{\partial \mathbf{W}_y}{\partial \mathbf{p}_1} & \frac{\partial \mathbf{W}_y}{\partial \mathbf{p}_2} & \dots & \frac{\partial \mathbf{W}_y}{\partial \mathbf{p}_n} \end{pmatrix}$$

For example, for affine

$$\mathbf{W}(\mathbf{x}; \mathbf{p}) = \begin{pmatrix} 1 + d_{xx} & d_{xy} & d_x \\ d_{yx} & 1 + d_{yy} & d_y \end{pmatrix} \begin{pmatrix} x \\ y \\ 1 \end{pmatrix} = \begin{pmatrix} (1 + d_{xx})x + d_{xy}y + d_x \\ d_{yx}x + (1 + d_{yy})y + d_y \end{pmatrix}$$

$$\rightarrow \frac{\partial \mathbf{W}}{\partial \mathbf{p}} = \begin{pmatrix} x & 0 & y & 0 & 1 & 0 \\ 0 & x & 0 & y & 0 & 1 \\ d_{xx} & d_{yx} & d_{xy} & d_{yy} & d_x & d_y \end{pmatrix}$$

Parametric model

$$\arg \min_{\Delta \mathbf{p}} \sum_{\mathbf{x}} \left(I(\mathbf{W}(\mathbf{x}; \mathbf{p})) + \nabla I \frac{\partial \mathbf{W}}{\partial \mathbf{p}} \Delta \mathbf{p} - T(\mathbf{x}) \right)^2$$

$$\rightarrow 0 = \sum_{\mathbf{x}} \left[\nabla I \frac{\partial \mathbf{W}}{\partial \mathbf{p}} \right]^T \left[I(\mathbf{W}(\mathbf{x}; \mathbf{p})) + \nabla I \frac{\partial \mathbf{W}}{\partial \mathbf{p}} \Delta \mathbf{p} - T(\mathbf{x}) \right]$$

$$\Delta \mathbf{p} = \mathbf{H}^{-1} \sum_{\mathbf{x}} \left[\nabla I \frac{\partial \mathbf{W}}{\partial \mathbf{p}} \right]^T [T(\mathbf{x}) - I(\mathbf{W}(\mathbf{x}; \mathbf{p}))]$$

(Approximated) Hessian $\mathbf{H} = \sum_{\mathbf{x}} \left[\nabla I \frac{\partial \mathbf{W}}{\partial \mathbf{p}} \right]^T \left[\nabla I \frac{\partial \mathbf{W}}{\partial \mathbf{p}} \right]$

Lucas-Kanade algorithm

iterate

- 1) warp I with $W(x;p)$
- 2) compute error image $T(x,y)-I(W(x,p))$
- 3) compute gradient image ∇I with $W(x,p)$
- 4) evaluate Jacobian $\frac{\partial W}{\partial p}$ at $(x;p)$
- 5) compute $\nabla I \frac{\partial W}{\partial p}$
- 6) compute Hessian
- 7) compute $\sum_x \left[\nabla I \frac{\partial W}{\partial p} \right]^T [T(x) - I(W(x;p))]$
- 8) solve Δp
- 9) update p by $p + \Delta p$

until converge

$$\Delta \mathbf{p} = \mathbf{H}^{-1} \sum_x \left[\nabla I \frac{\partial \mathbf{W}}{\partial \mathbf{p}} \right]^T [T(\mathbf{x}) - I(\mathbf{W}(\mathbf{x};\mathbf{p}))]$$

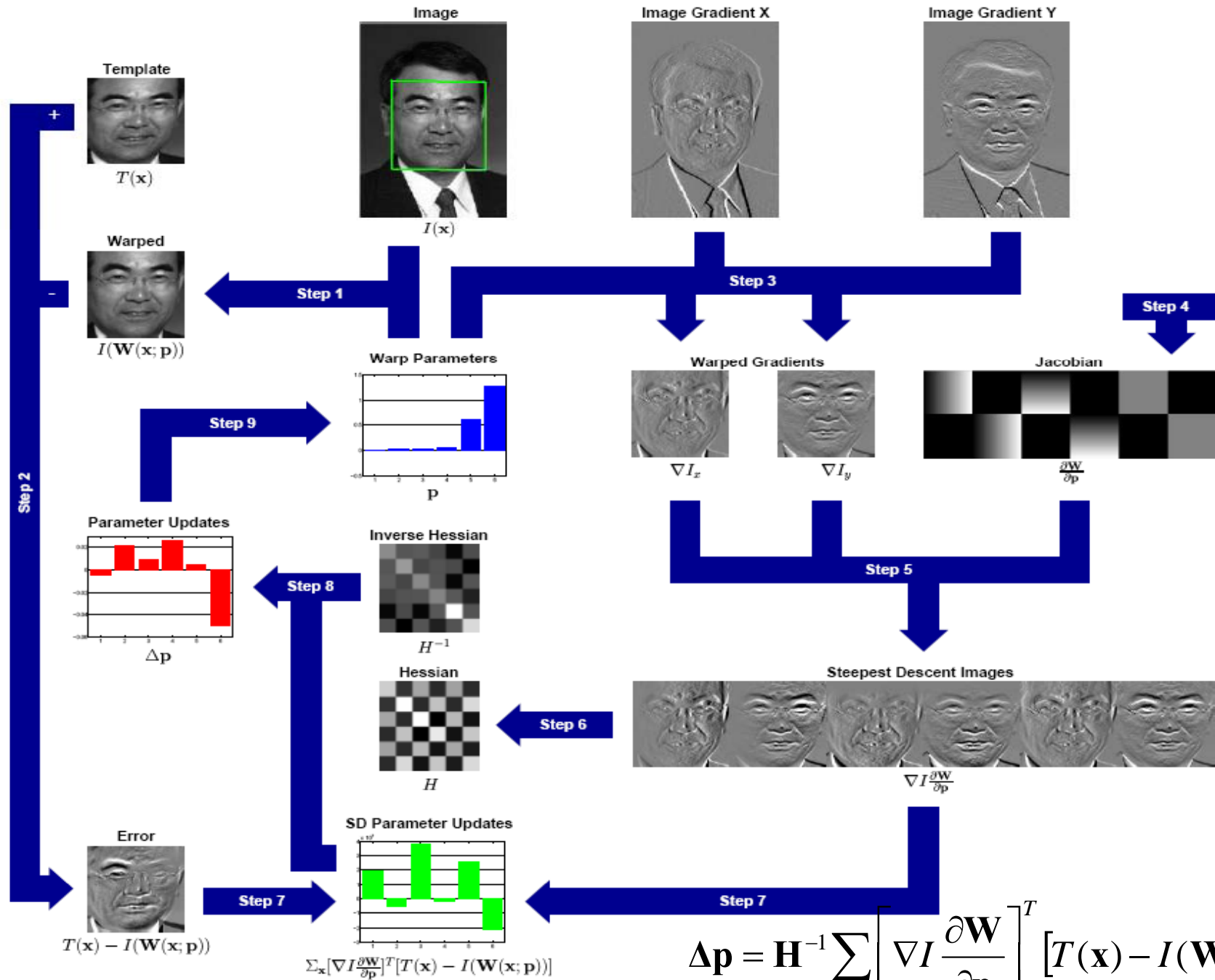

$$\Delta p = H^{-1} \sum_x \left[\nabla I \frac{\partial W}{\partial p} \right]^T [T(x) - I(W(x;p))]$$

Coarse-to-fine strategy

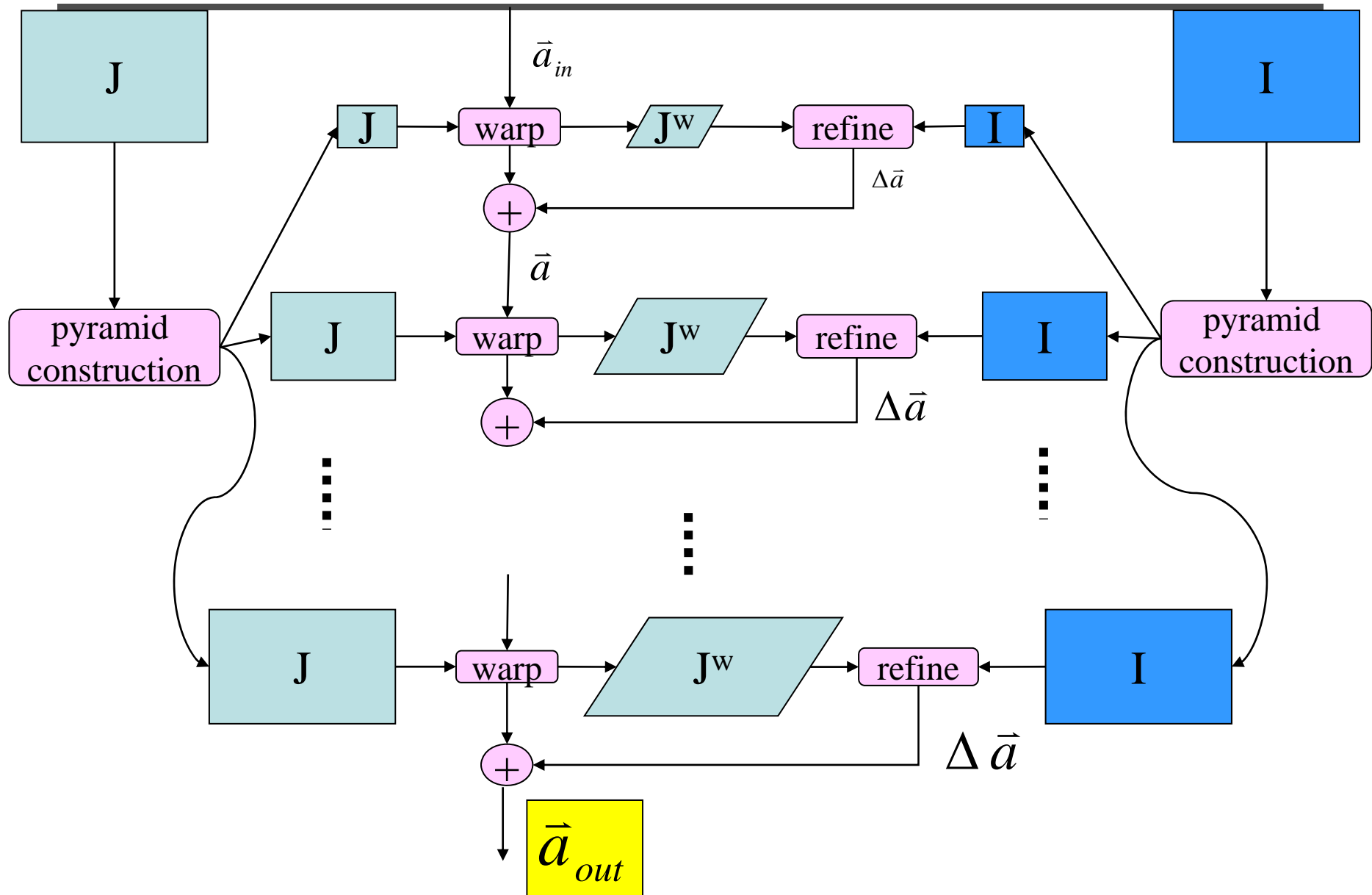

Application of image alignment



Direct vs feature-based

- Direct methods use all information and can be very accurate, but they depend on the fragile “brightness constancy” assumption.
- Iterative approaches require **initialization**.
- Not robust to illumination change and noise images.
- In early days, direct method is better.

- Feature based methods are now more robust and potentially faster.
- Even better, it can recognize panorama without initialization.

Tracking

Tracking

$$I(x,y,t) \xrightarrow{(u, v)} I(x+u,y+v,t+1)$$



Tracking

brightness constancy $I(x+u, y+v, t+1) - I(x, y, t) = 0$

$$I(x, y, t) + uI_x(x, y, t) + vI_y(x, y, t) + I_t(x, y, t) - I(x, y, t) \approx 0$$

$$uI_x(x, y, t) + vI_y(x, y, t) + I_t(x, y, t) = 0$$

$$I_x u + I_y v + I_t = 0 \quad \text{optical flow constraint equation}$$

Optical flow constraint equation

At a single image pixel, we get a line:

$$I_x u + I_y v = -I_t$$

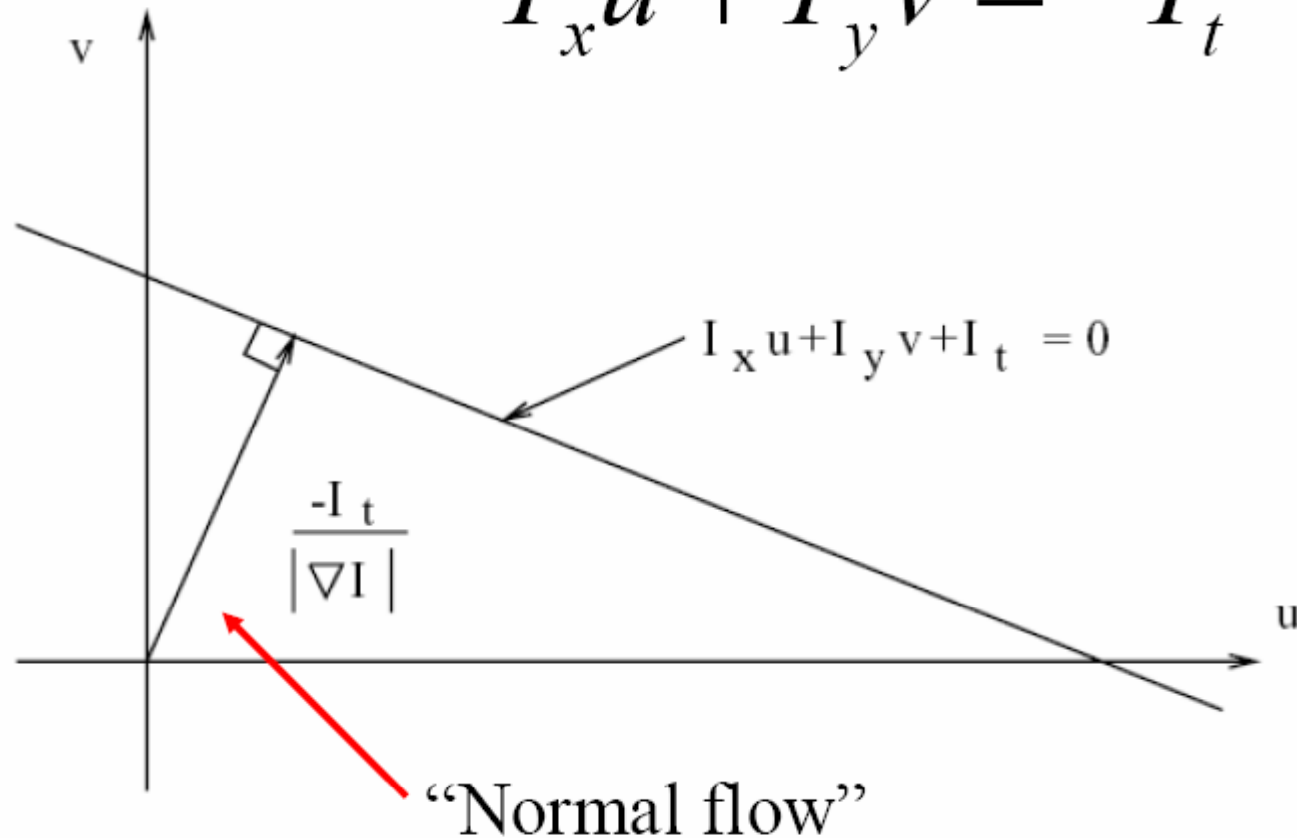

Multiple constraints

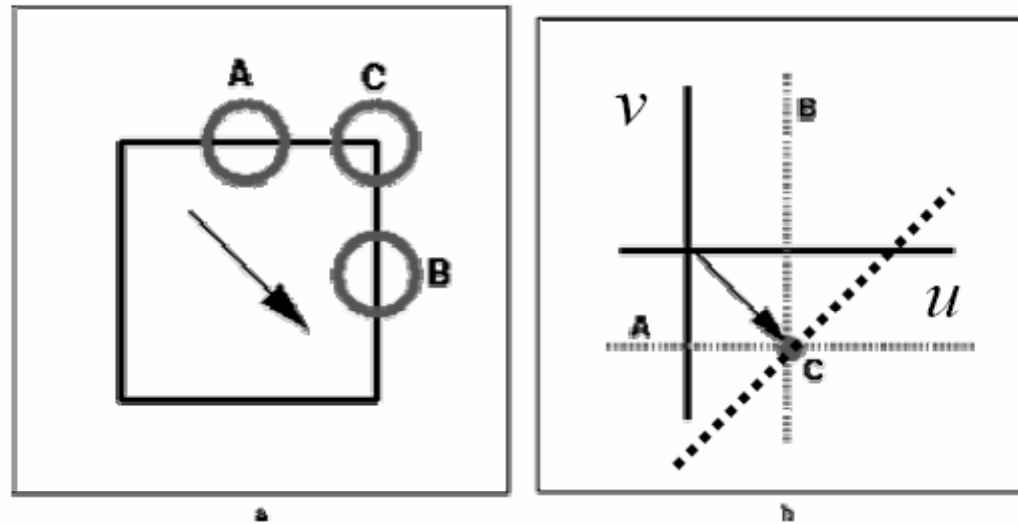

Combine constraints to get an estimate of velocity.

Area-based method

- Assume spatial smoothness

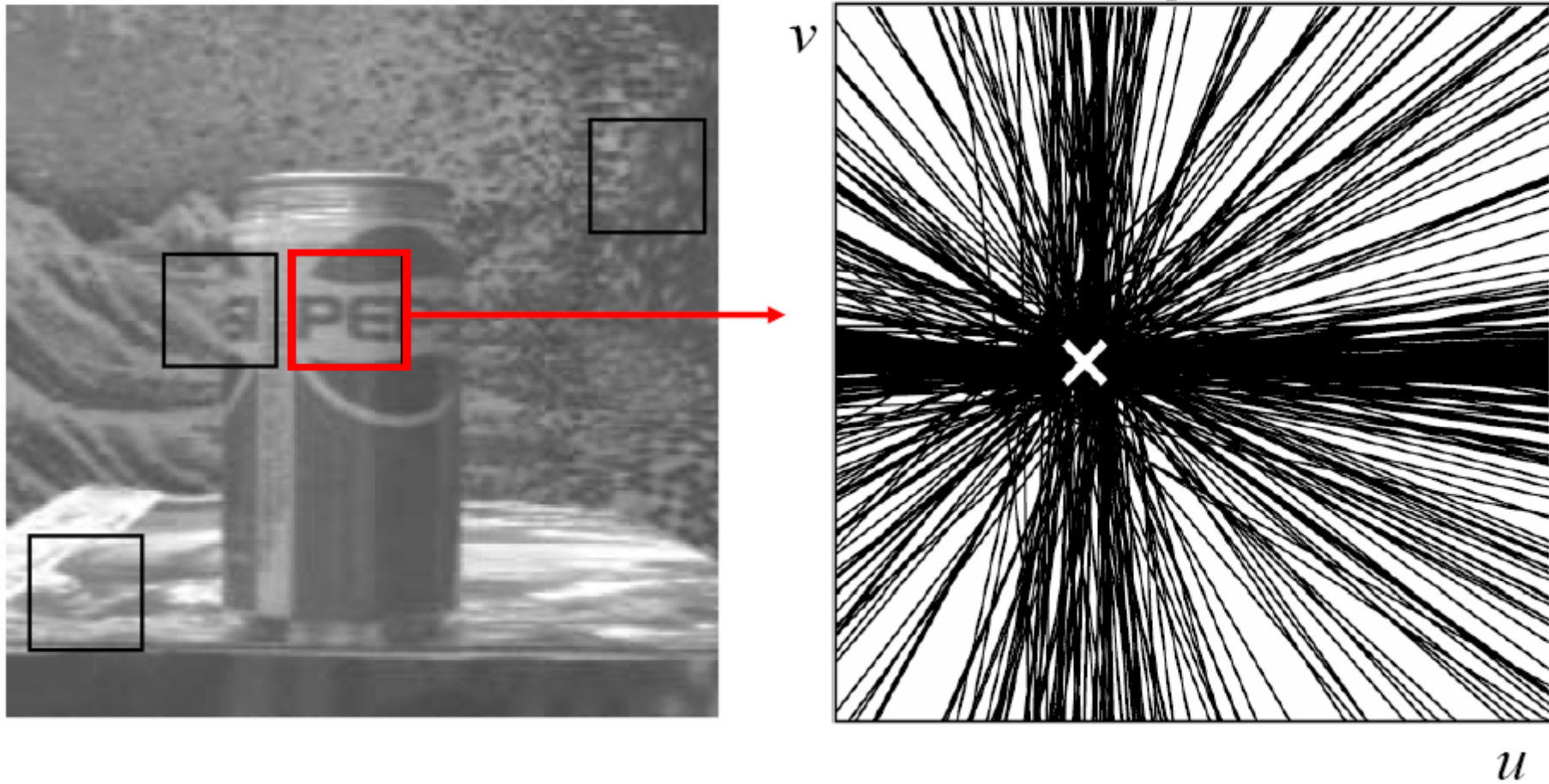

Area-based method

- Assume spatial smoothness

$$E(u, v) = \sum_{x,y} (I_x u + I_y v + I_t)^2$$

$$\frac{\partial E}{\partial u} = \sum_R (I_x u + I_y v + I_t) I_x = 0$$

$$\frac{\partial E}{\partial v} = \sum_R (I_x u + I_y v + I_t) I_y = 0$$

Area-based method

$$\left[\sum_R I_x^2 \right] u + \left[\sum_R I_x I_y \right] v = - \sum_R I_x I_t$$

$$\left[\sum_R I_x I_y \right] u + \left[\sum_R I_y^2 \right] v = - \sum_R I_y I_t$$

$$\begin{bmatrix} \sum I_x^2 & \sum I_x I_y \\ \sum I_y I_x & \sum I_y^2 \end{bmatrix} \begin{bmatrix} u \\ v \end{bmatrix} = \begin{bmatrix} - \sum I_x I_t \\ - \sum I_y I_t \end{bmatrix}$$

must be invertible

Area-based method

- The eigenvalues tell us about the local image structure.
- They also tell us how well we can estimate the flow in both directions.
- [Link to Harris corner detector.](#)

Textured area

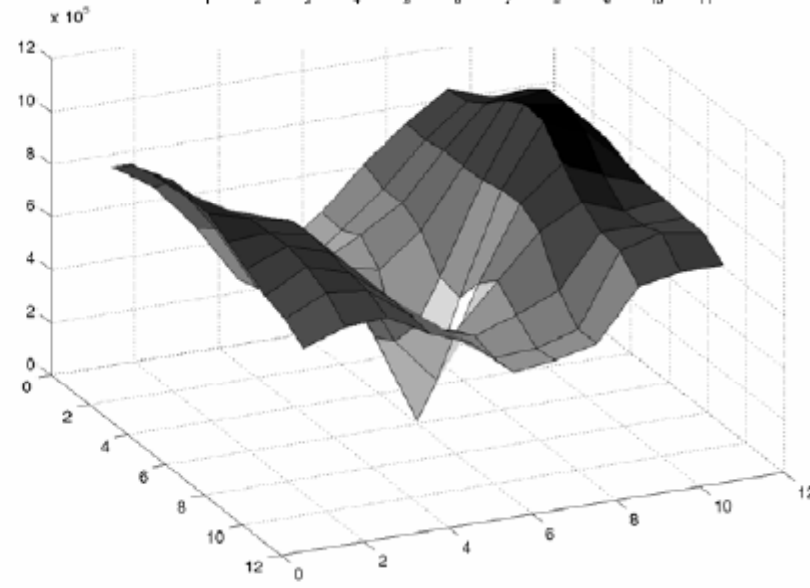
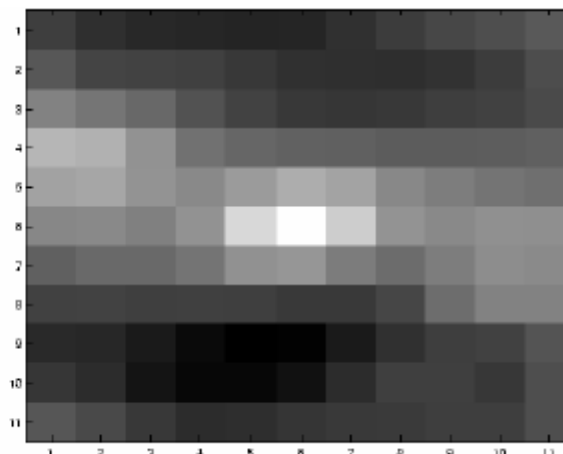

$$\begin{bmatrix} \sum I_x^2 & \sum I_x I_y \\ \sum I_y I_x & \sum I_y^2 \end{bmatrix}$$

Gradients in x and y.

Edge

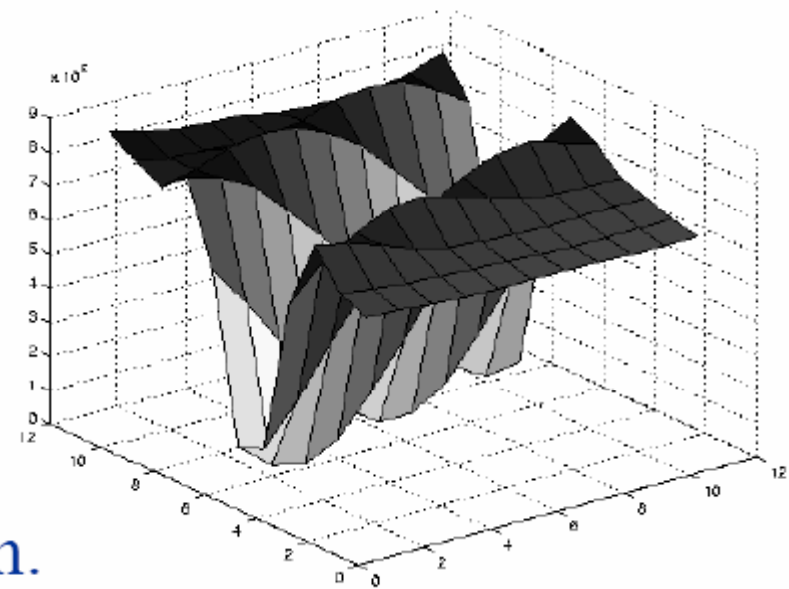
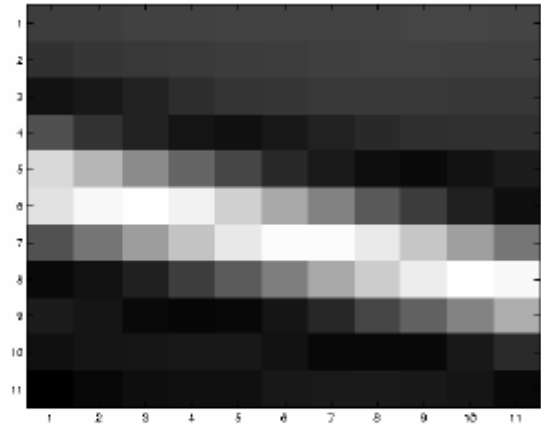

$$\begin{bmatrix} \sum I_x^2 & \sum I_x I_y \\ \sum I_y I_x & \sum I_y^2 \end{bmatrix}$$

Gradients oriented in one direction.

Homogenous area

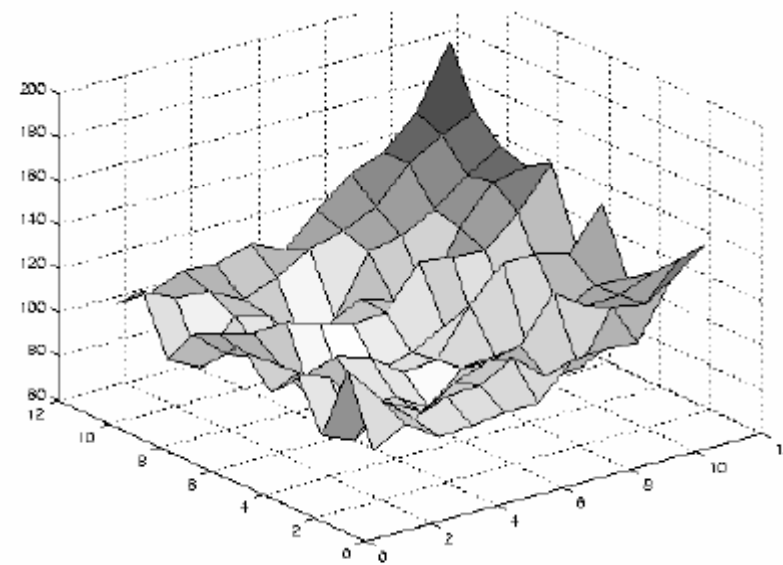
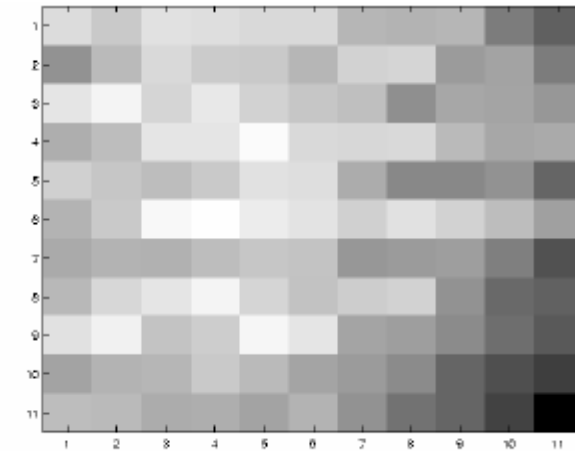
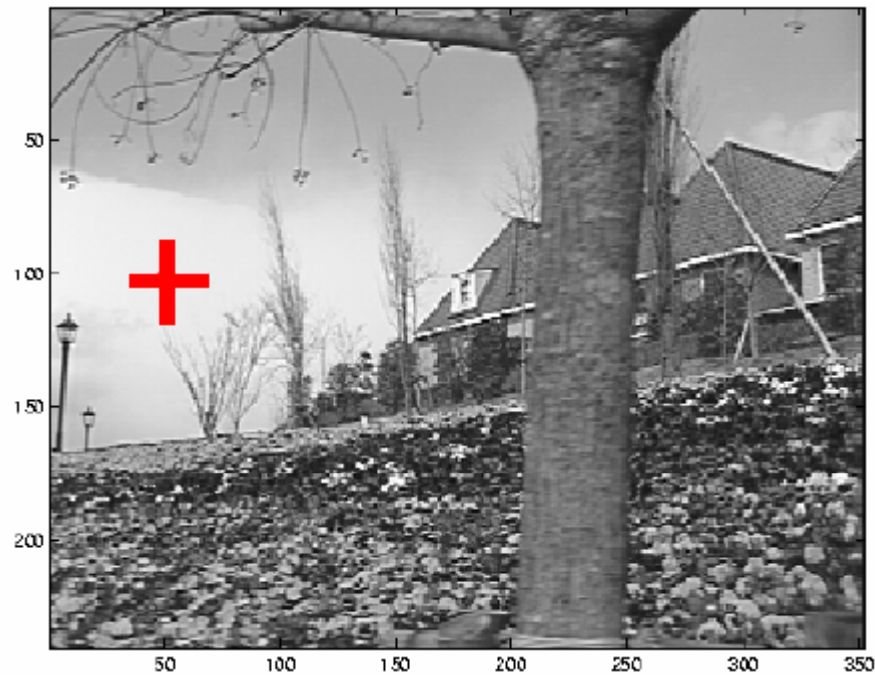

$$\begin{bmatrix} \sum I_x^2 & \sum I_x I_y \\ \sum I_y I_x & \sum I_y^2 \end{bmatrix}$$

Weak gradients everywhere.

KLT tracking

- Select features by $\min(\lambda_1, \lambda_2) > \lambda$
- Monitor features by measuring dissimilarity

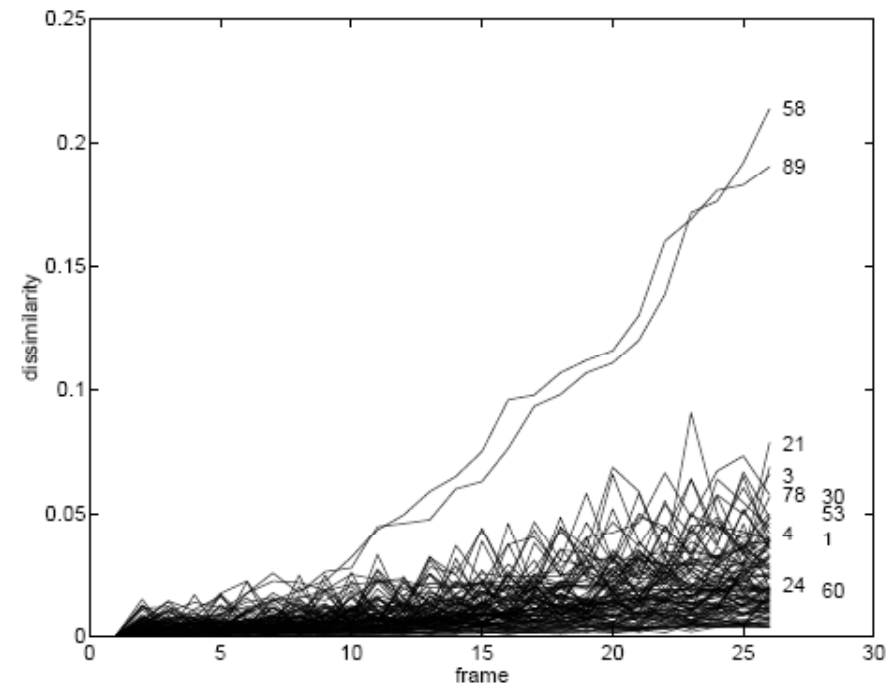
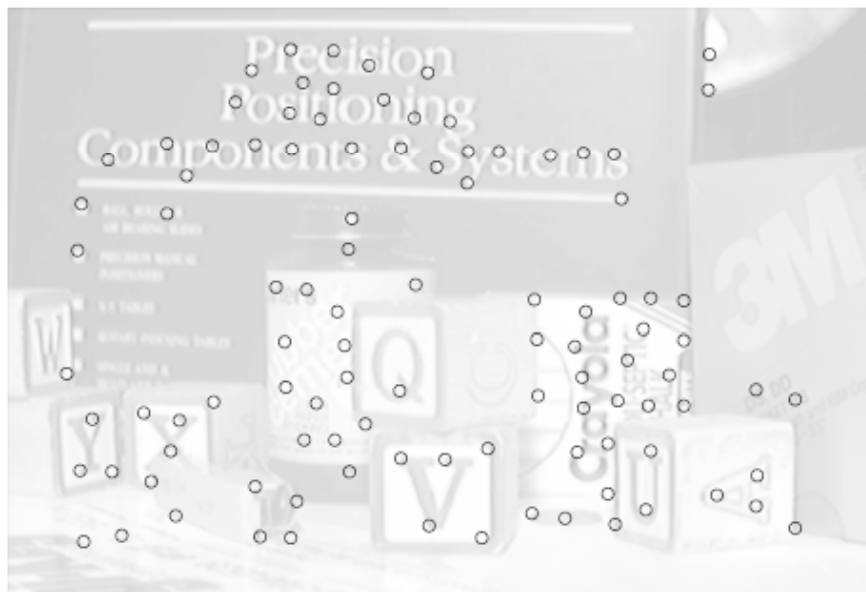

Aperture problem

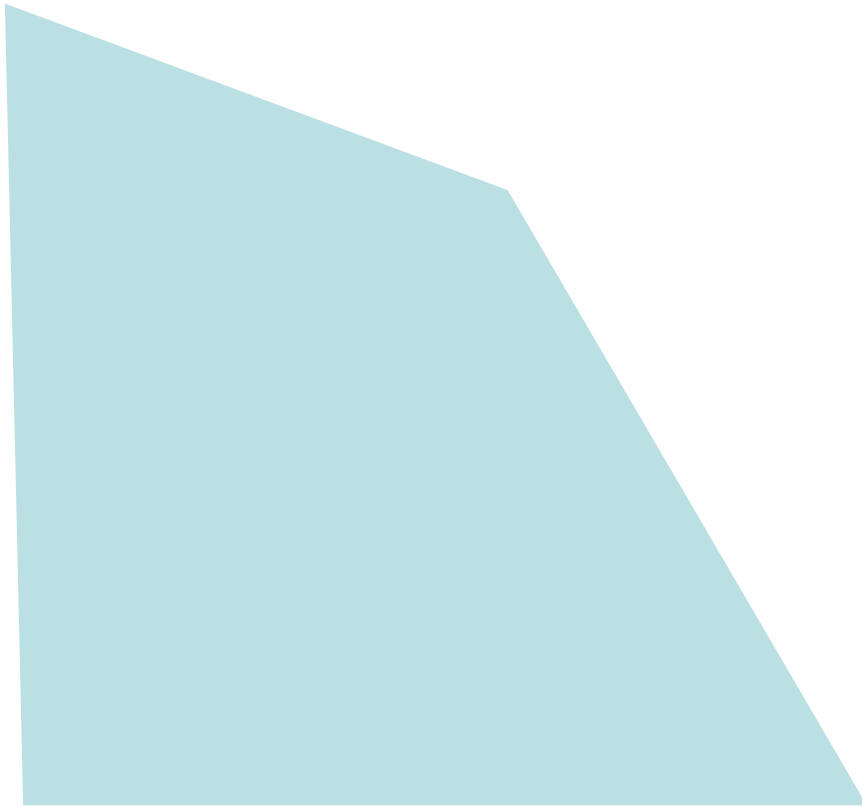

Aperture problem

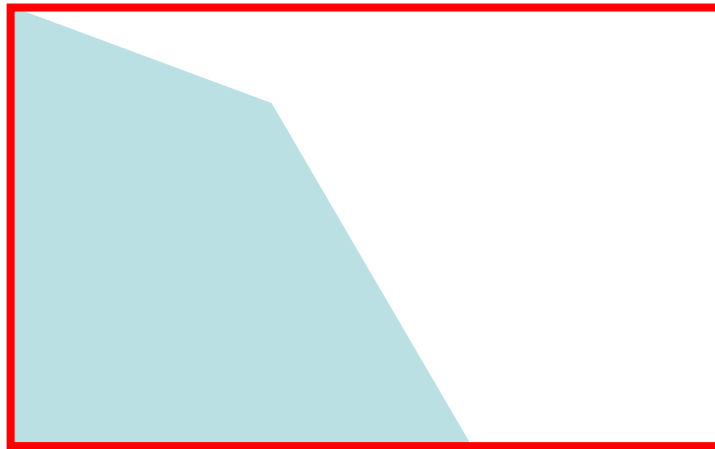

Aperture problem

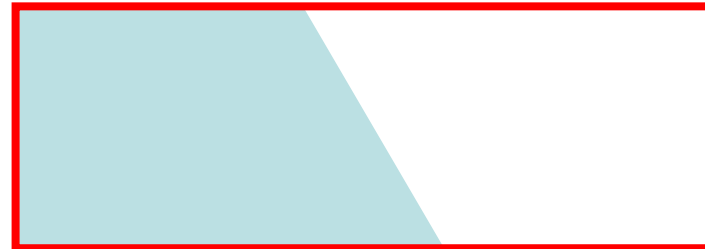

Demo for aperture problem

- http://www.sandlotscience.com/Distortions/Breathing_Square.htm
- http://www.sandlotscience.com/Ambiguous/Barberpole_Illusion.htm

Aperture problem

- Larger window reduces ambiguity, but easily violates spatial smoothness assumption

Affine Flow

$$E(\mathbf{a}) = \sum_{x,y \in R} (\nabla I^T \mathbf{u}(\mathbf{x}; \mathbf{a}) + I_t)^2$$

$$\mathbf{u}(\mathbf{x}; \mathbf{a}) = \begin{bmatrix} u(\mathbf{x}; \mathbf{a}) \\ v(\mathbf{x}; \mathbf{a}) \end{bmatrix} = \begin{bmatrix} a_1 + a_2x + a_3y \\ a_4 + a_5x + a_6y \end{bmatrix}$$

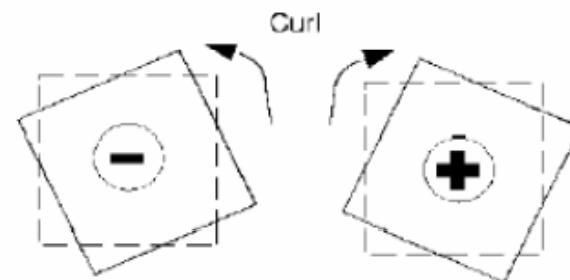
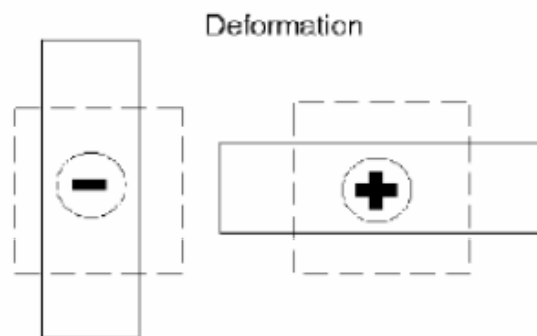
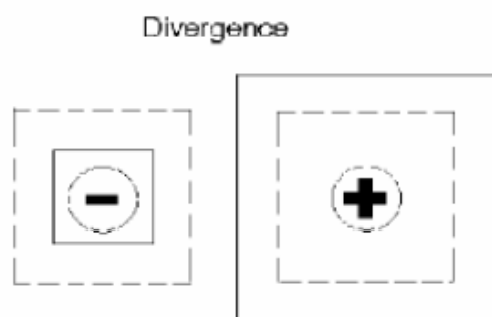

Optimization

$$E(\mathbf{a}) = \sum_{x,y \in R} (I_x a_1 + I_x a_2 x + I_x a_3 y + I_y a_4 + I_y a_5 x + I_y a_6 y + I_t)^2$$

Differentiate wrt the a_i and set equal to zero.

$$\begin{bmatrix} \Sigma I_x^2 & \Sigma I_x^2 x & \Sigma I_x^2 y & \Sigma I_x I_y & \Sigma I_x I_y x & \Sigma I_x I_y y \\ \Sigma I_x^2 x & \Sigma I_x^2 x^2 & \Sigma I_x^2 xy & \Sigma I_x I_y x & \Sigma I_x I_y x^2 & \Sigma I_x I_y xy \\ & & & \vdots & & \\ & & & & & \\ & & & & & \\ & & & & & \\ & & & & & \end{bmatrix} \begin{bmatrix} a_1 \\ a_2 \\ a_3 \\ a_4 \\ a_5 \\ a_6 \end{bmatrix} = \begin{bmatrix} -\Sigma I_x I_t \\ -\Sigma I_x I_t x \\ -\Sigma I_x I_t y \\ -\Sigma I_y I_t \\ -\Sigma I_y I_t x \\ -\Sigma I_y I_t y \end{bmatrix}$$

KLT tracking



<http://www.ces.clemson.edu/~stb/klt/>

KLT tracking



<http://www.ces.clemson.edu/~stb/klt/>

SIFT tracking (matching actually)



Frame 0



Frame 10

SIFT tracking



Frame 0



Frame 100

SIFT tracking



Frame 0



Frame 200

KLT vs SIFT tracking

- KLT has larger accumulating error; partly because our KLT implementation doesn't have affine transformation?
- SIFT is surprisingly robust
- Combination of SIFT and KLT ([example](#))

<http://www.frc.ri.cmu.edu/projects/buzzard/smalls/>

Rotoscoping (Max Fleischer 1914)

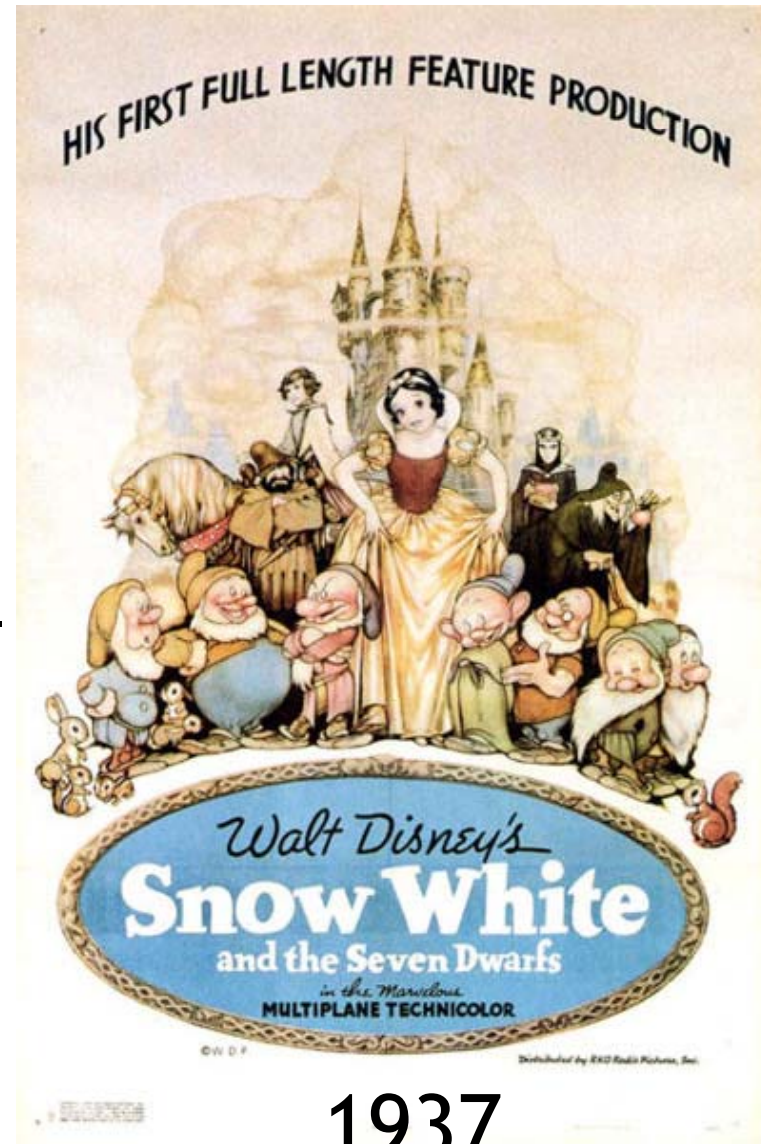
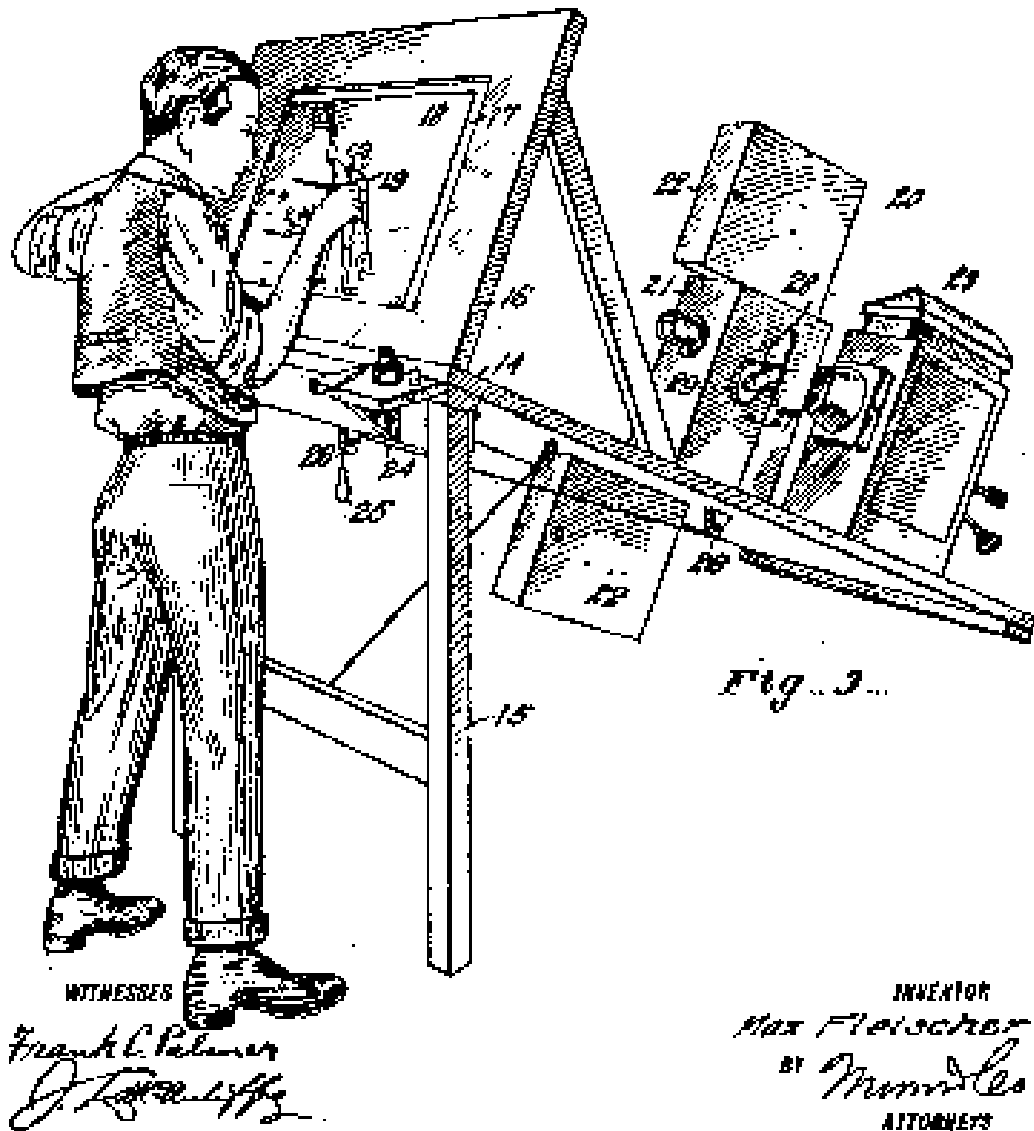

Tracking for rotoscoping

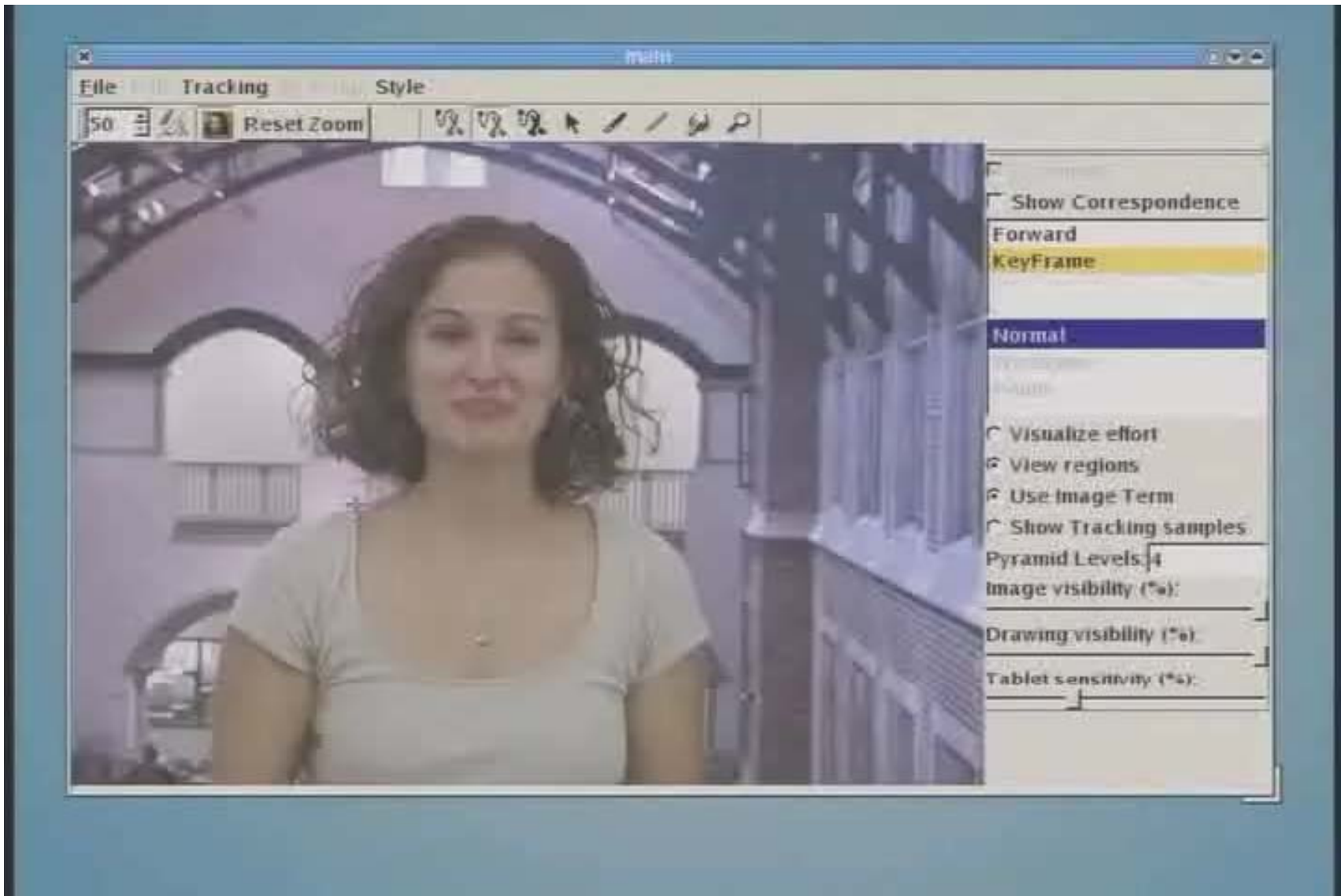

Tracking for rotoscoping

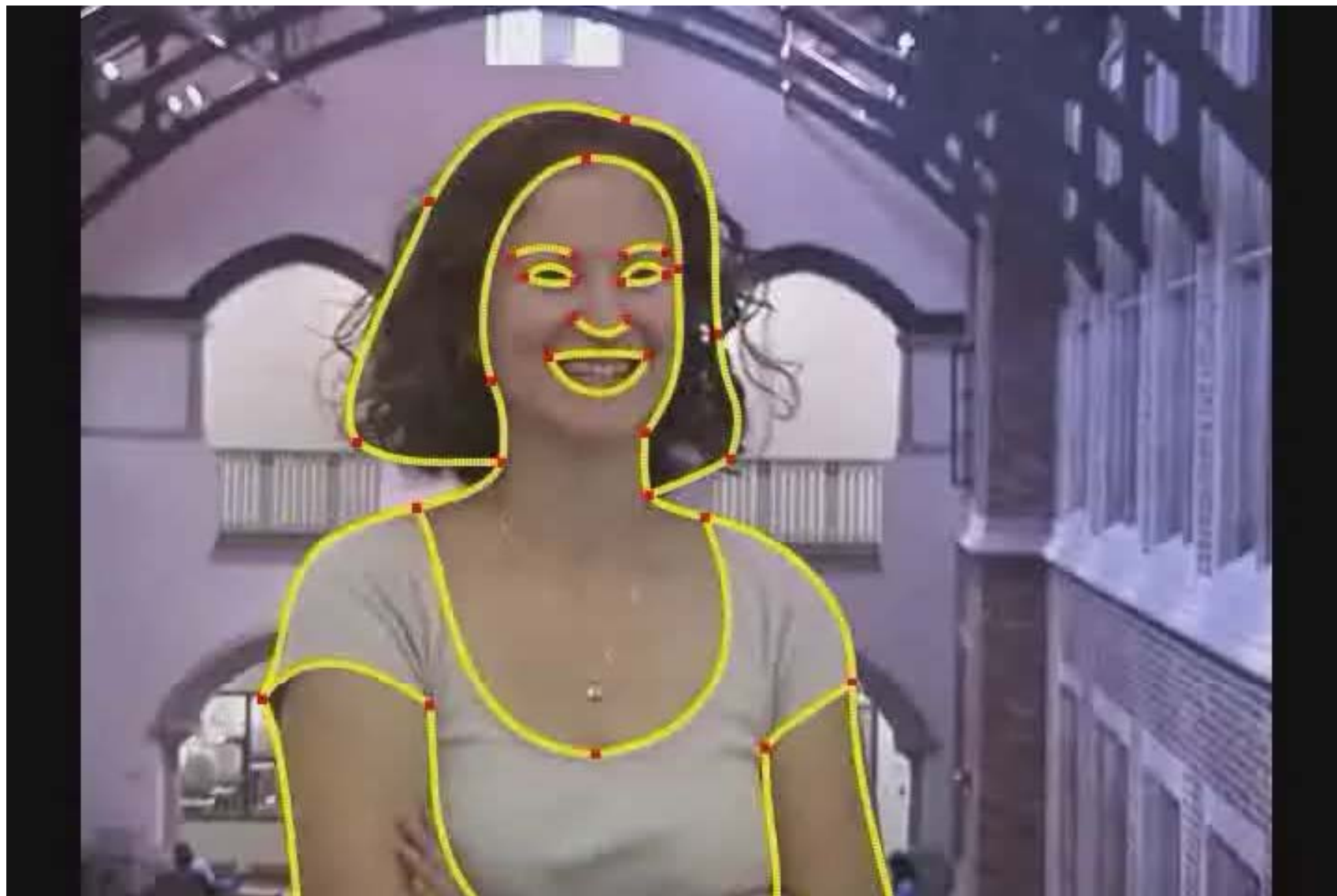

Waking life (2001)

DigiVFX



A Scanner Darkly (2006)

- Rotoshop, a proprietary software. Each minute of animation required 500 hours of work.



Optical flow

Single-motion assumption

Violated by

- Motion discontinuity
- Shadows
- Transparency
- Specular reflection
- ...

Multiple motion

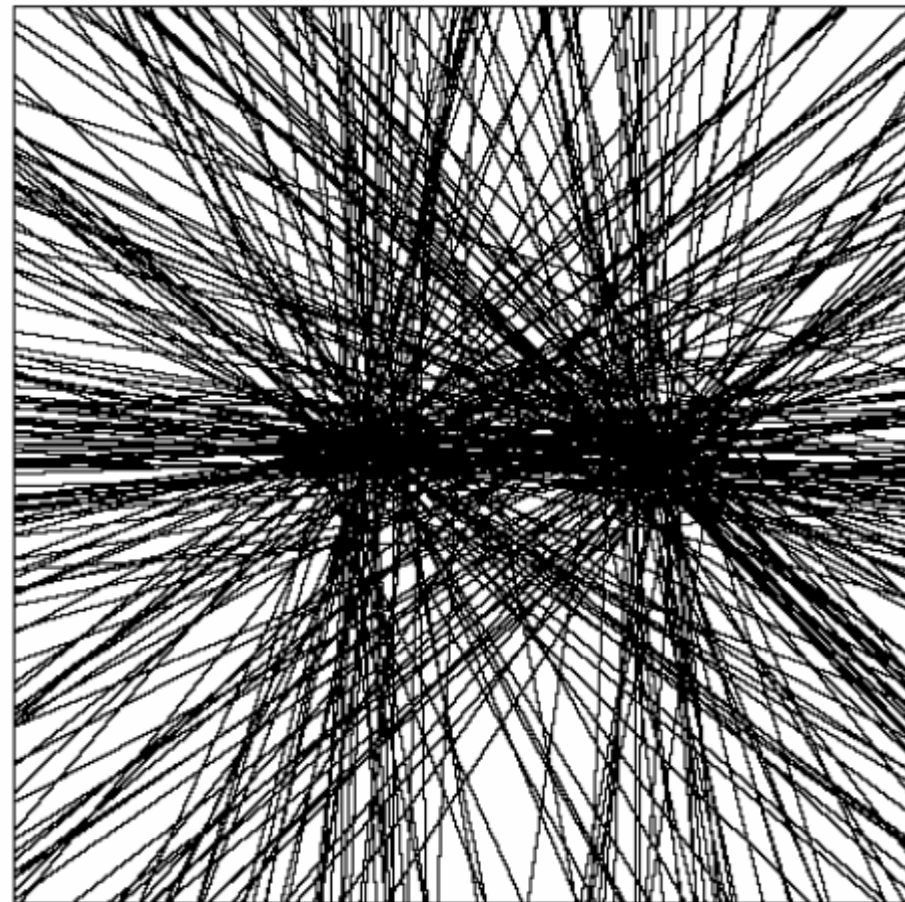
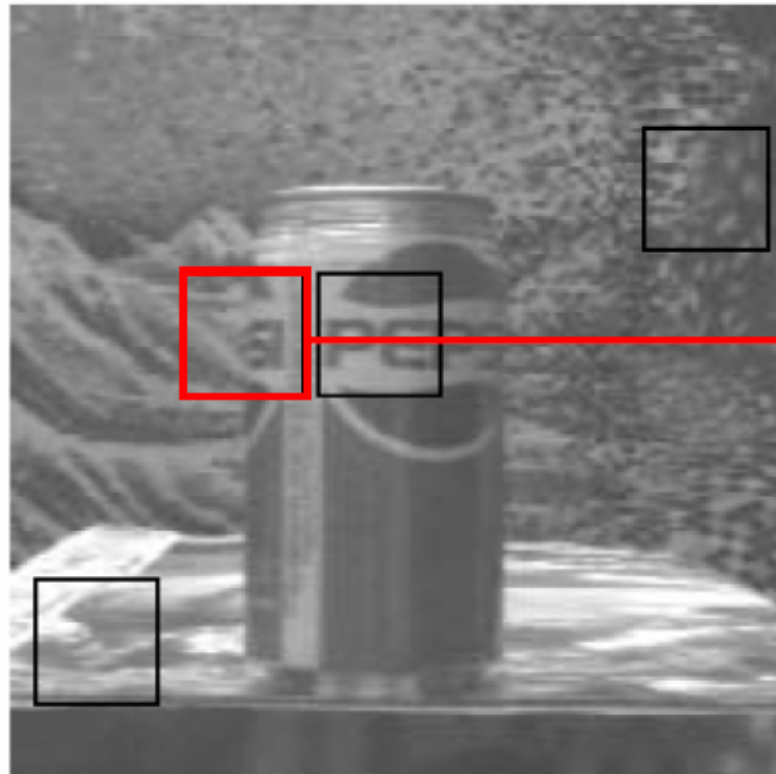

What is the “best” fitting translational motion?

Multiple motion

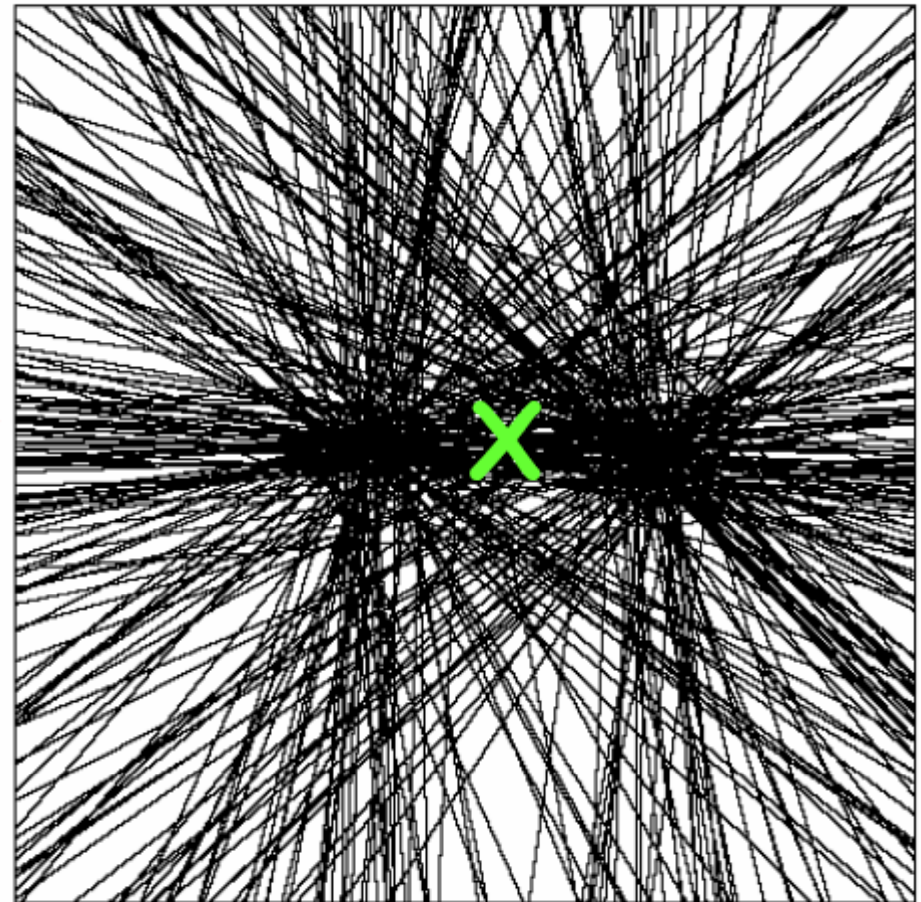
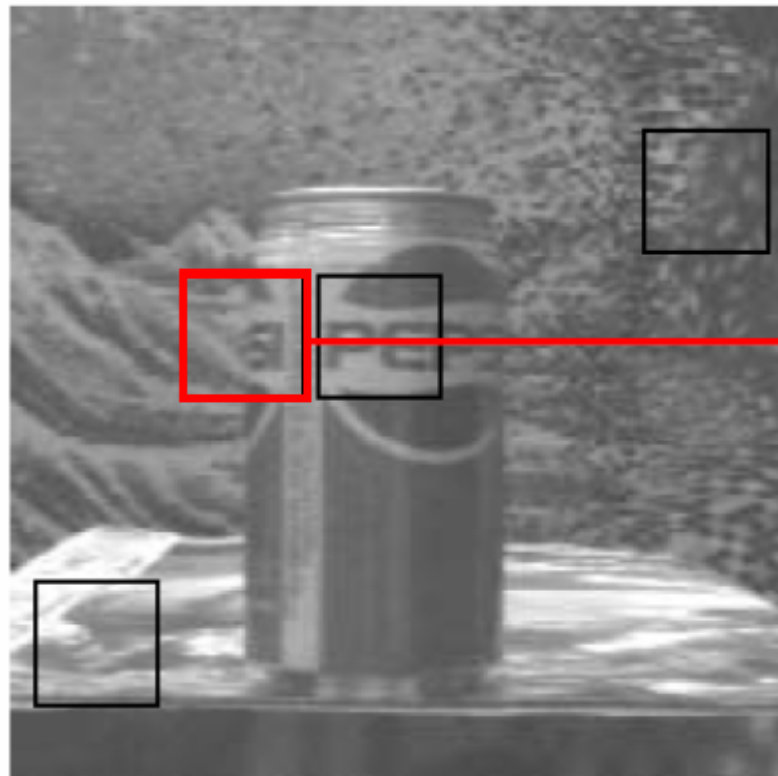

Least squares fit.

Simple problem: fit a line

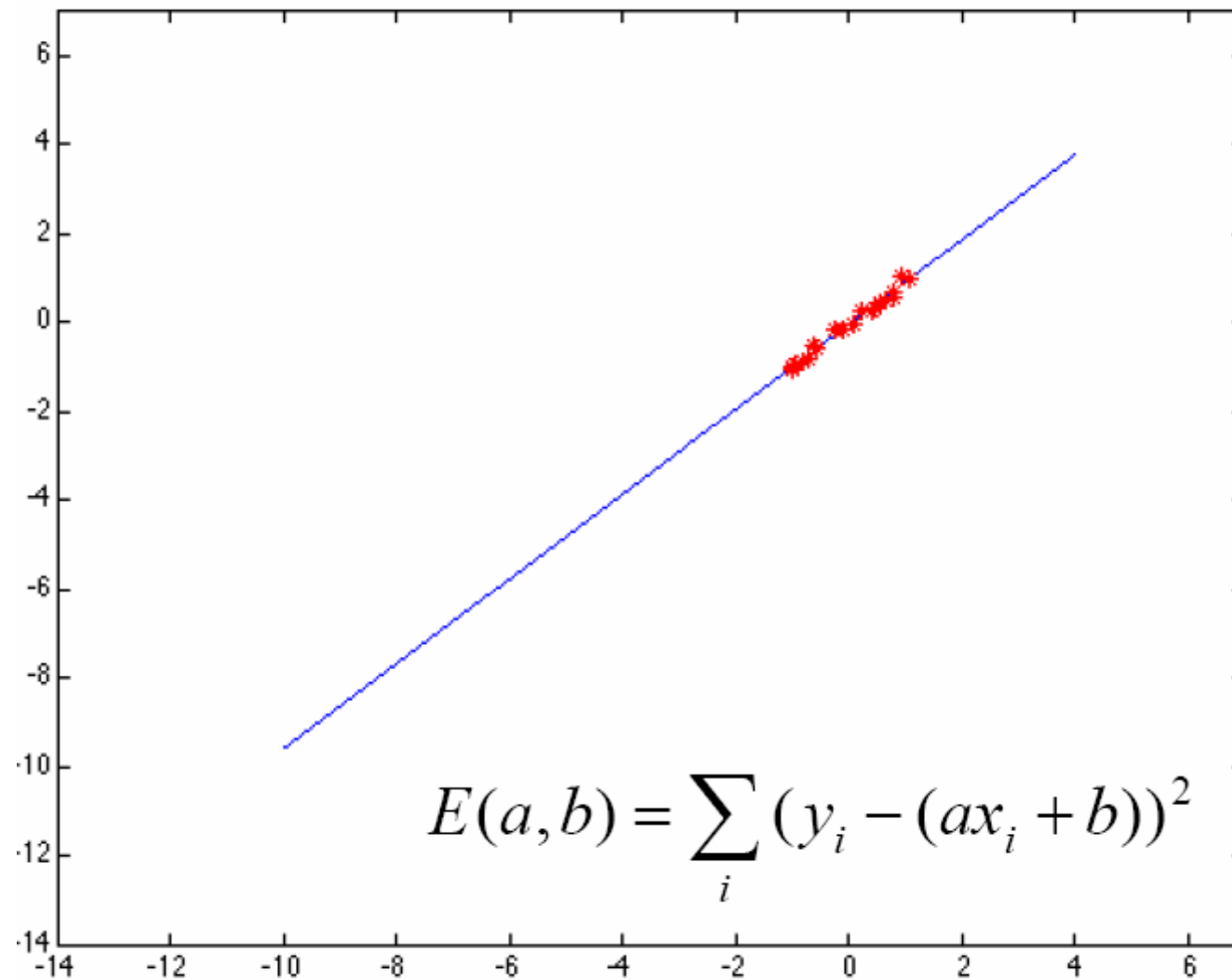

Least-square fit

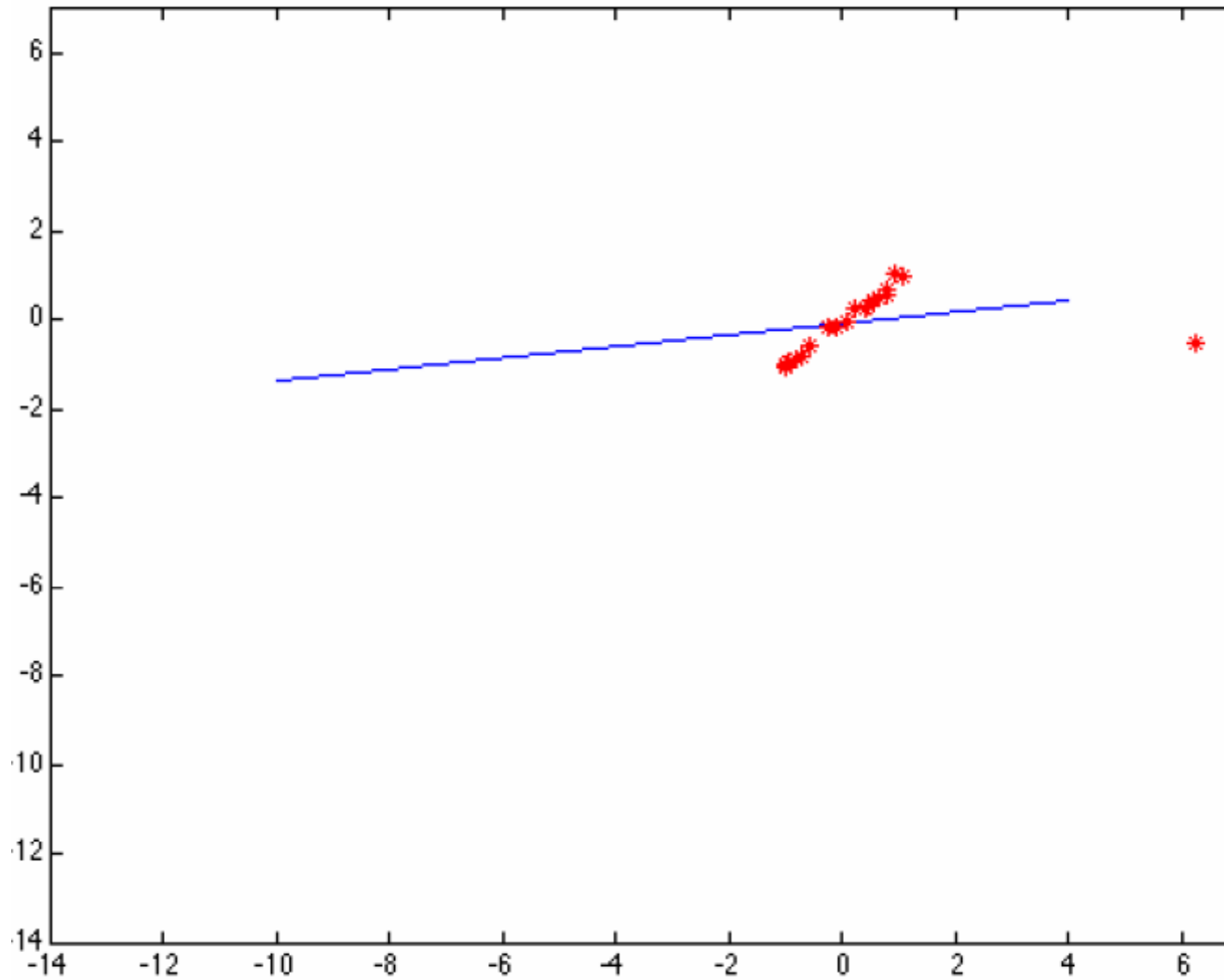

Least-square fit

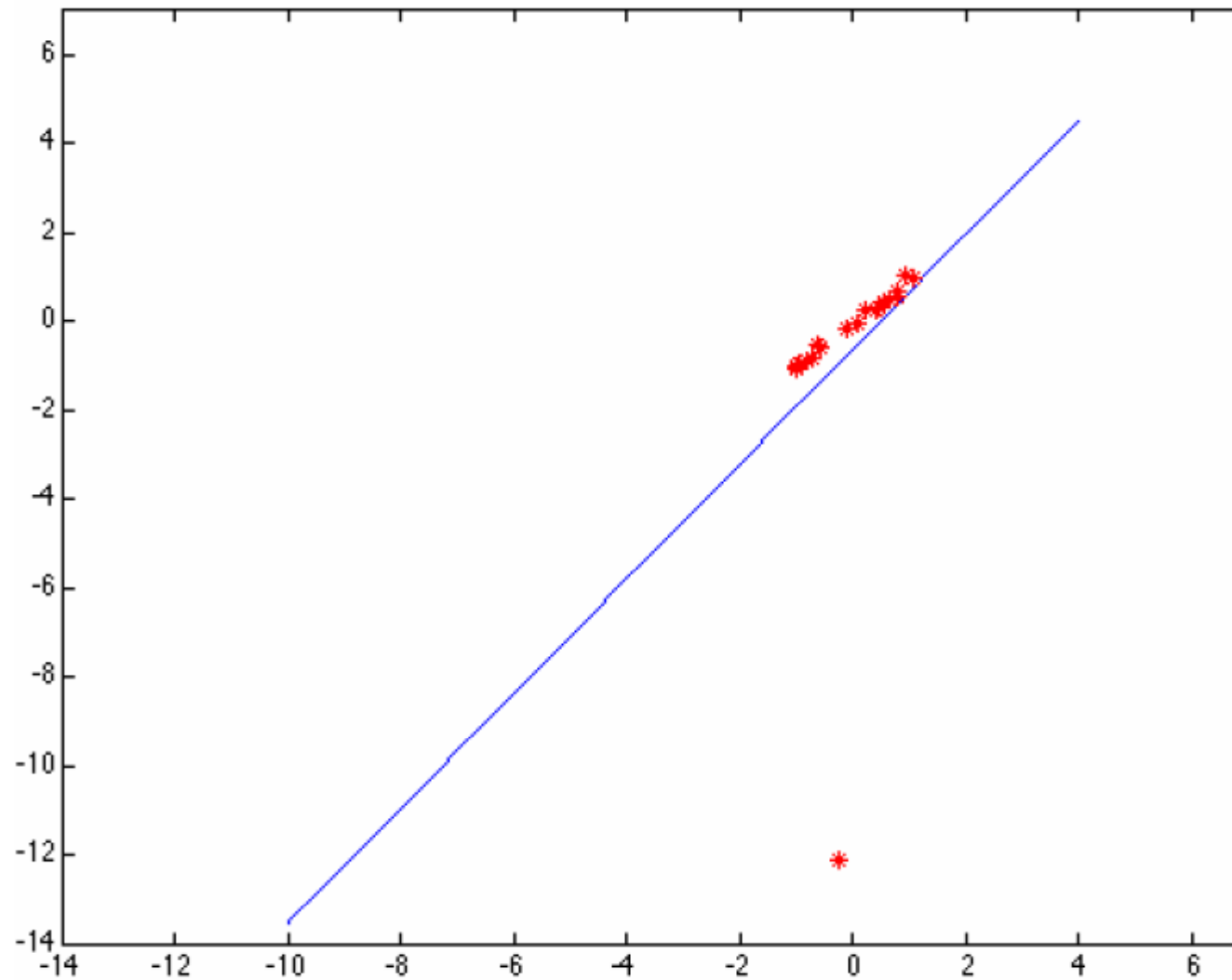

Robust statistics

- Recover the best fit for the **majority** of the data
- Detect and reject **outliers**

Approach

Influence is proportional to the derivative of the ρ function.

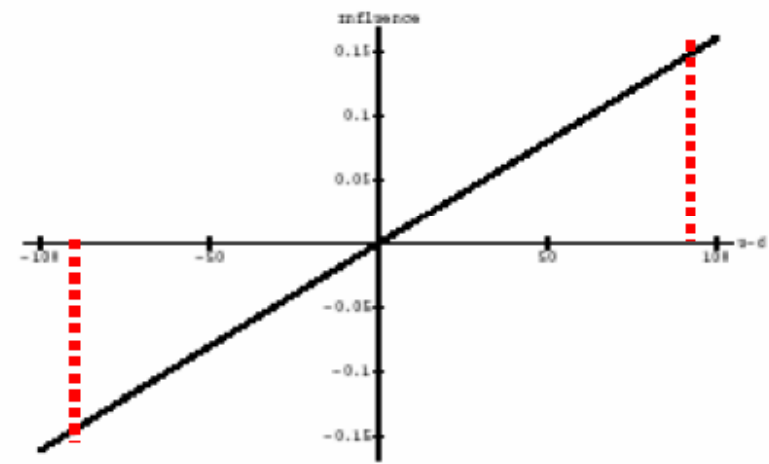
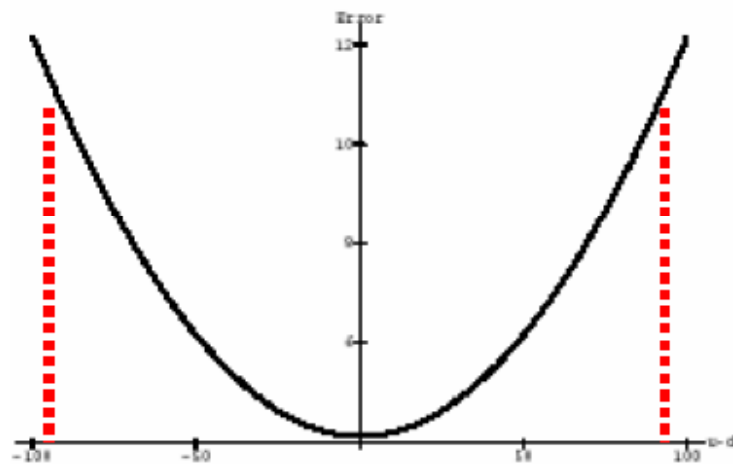

Want to give less influence to points beyond some value.

Robust weighting

$$\rho(x, \alpha, \lambda) = \begin{cases} \lambda x^2 & \text{if } |x| < \frac{\sqrt{\alpha}}{\sqrt{\lambda}}, \\ \alpha & \text{otherwise.} \end{cases} \quad \psi(x, \alpha, \lambda) = \begin{cases} 2\lambda x & \text{if } |x| < \frac{\sqrt{\alpha}}{\sqrt{\lambda}}, \\ 0 & \text{otherwise.} \end{cases}$$

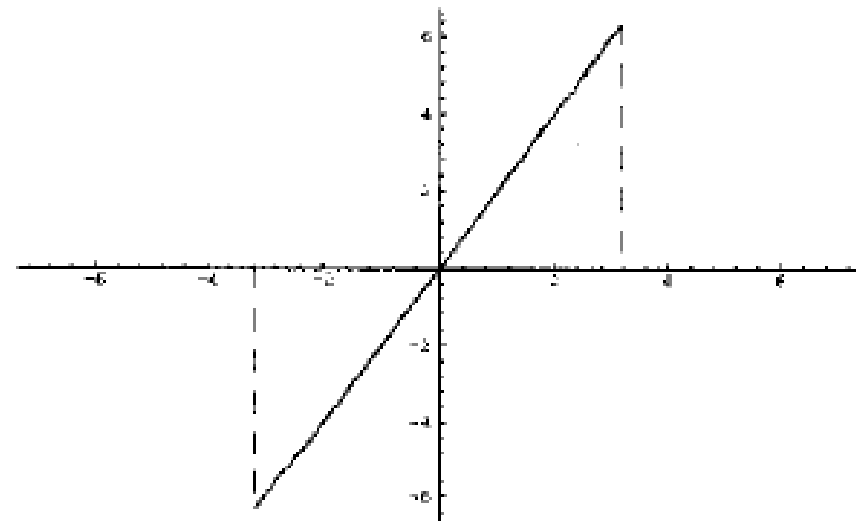
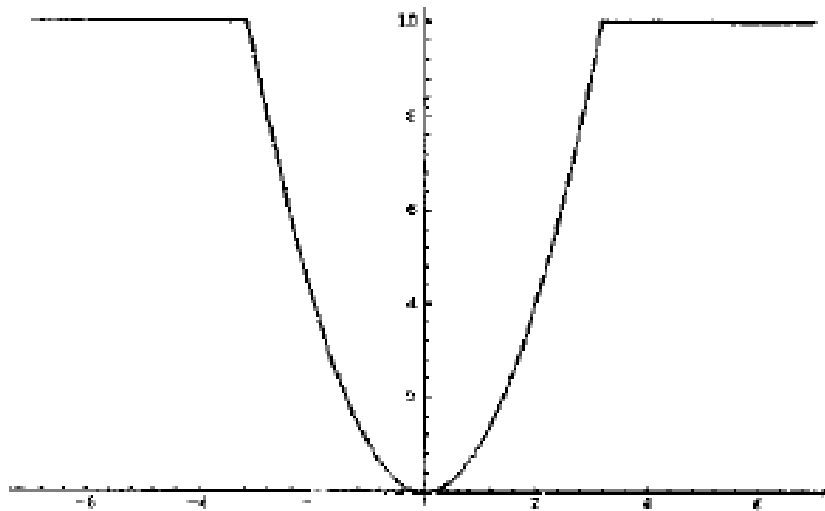

Truncated quadratic

Robust weighting

$$\rho(x, \sigma) = \frac{x^2}{\sigma + x^2}$$

$$\psi(x, \sigma) = \frac{2x\sigma}{(\sigma + x^2)^2}$$

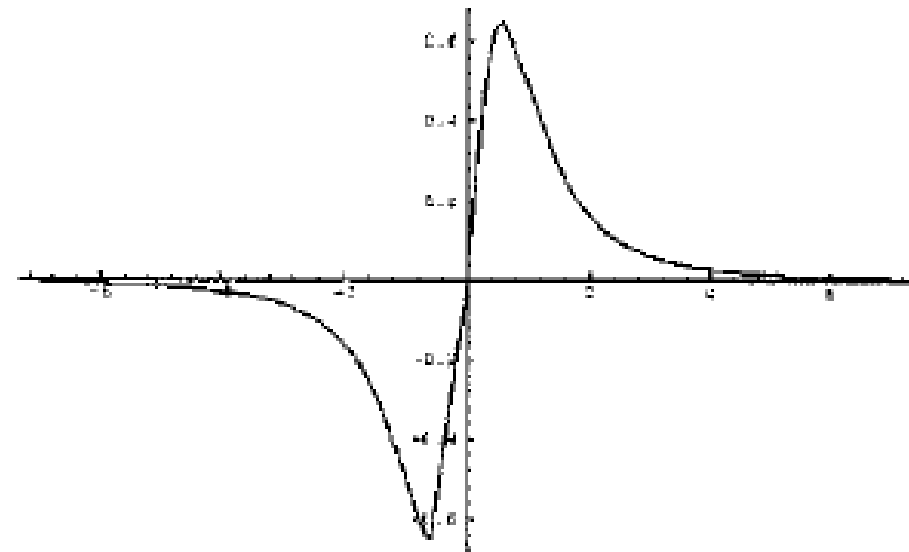
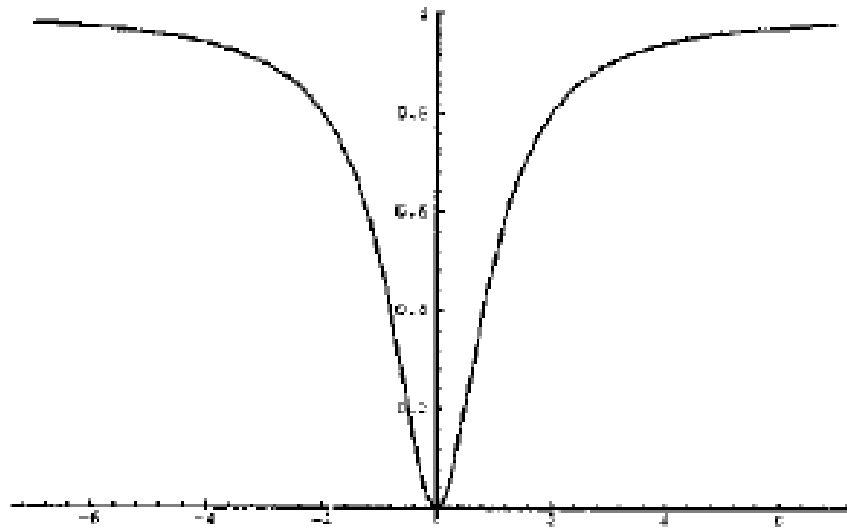

Geman & McClure

Robust estimation

$$E(\mathbf{a}) = \sum_{x,y \in R} \rho(I_x u + I_y v + I_t, \sigma)$$

Minimize: differentiate and set equal to zero:

$$\frac{\partial E}{\partial u} = \sum_{x,y \in R} \psi(I_x u + I_y v + I_t, \sigma) I_x = 0$$

$$\frac{\partial E}{\partial v} = \sum_{x,y \in R} \psi(I_x u + I_y v + I_t, \sigma) I_y = 0$$

No closed form solution!

Fragmented occlusion



Results

Dominant Motion

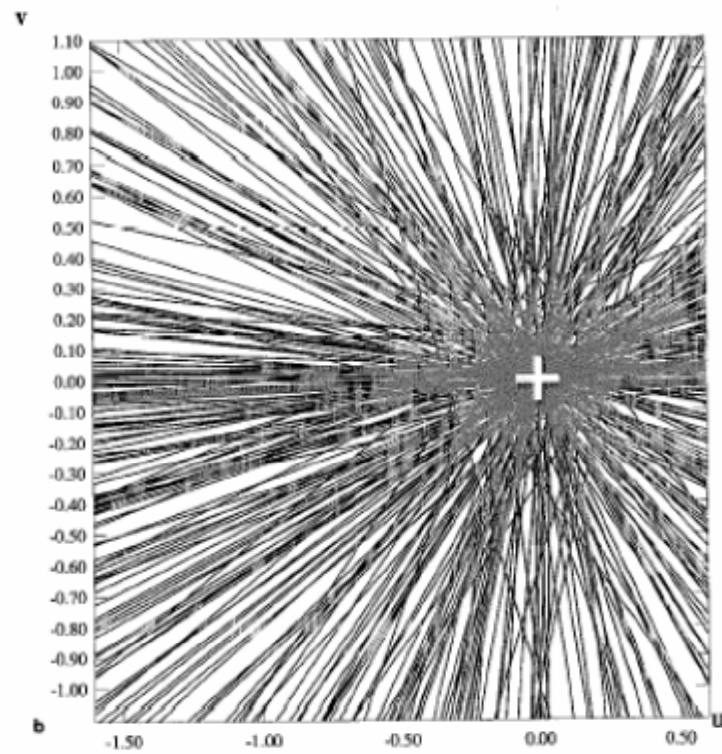

Results

Secondary Motion

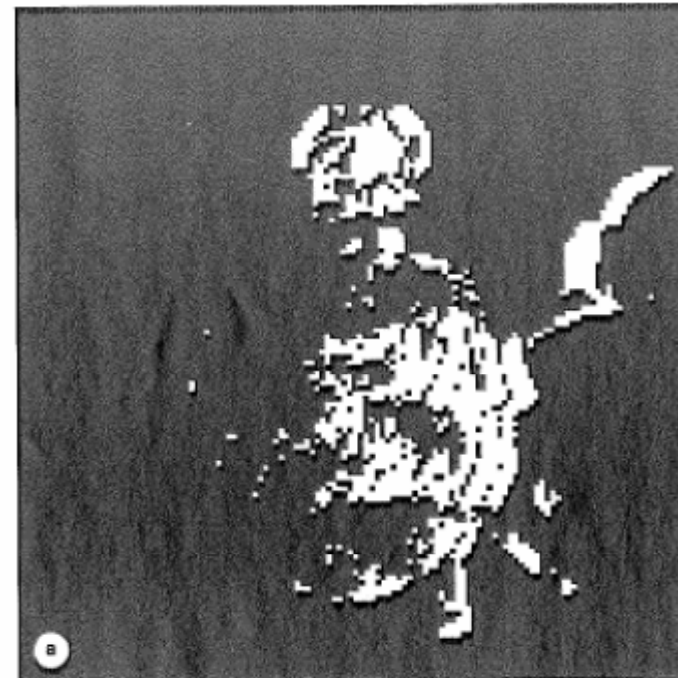
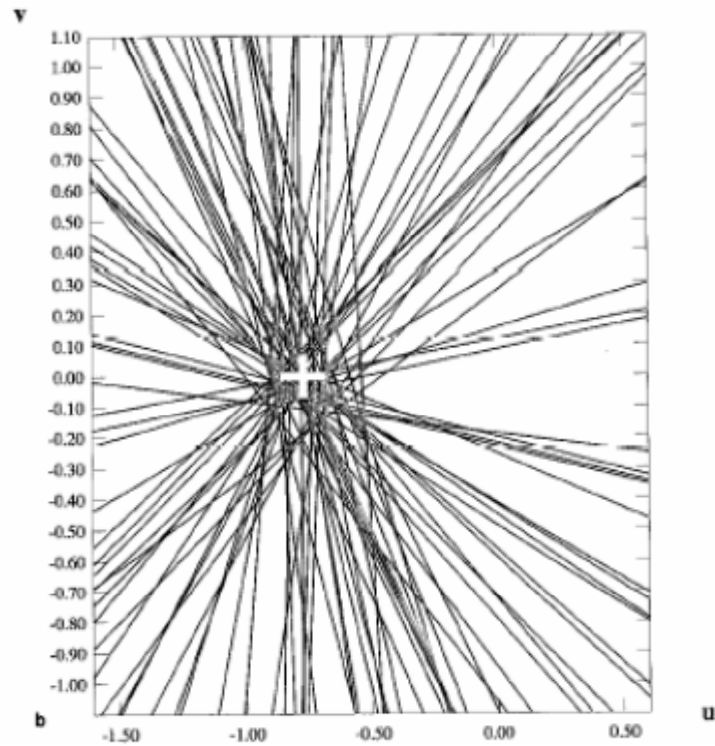

Regularization and dense optical flow DigiVFX

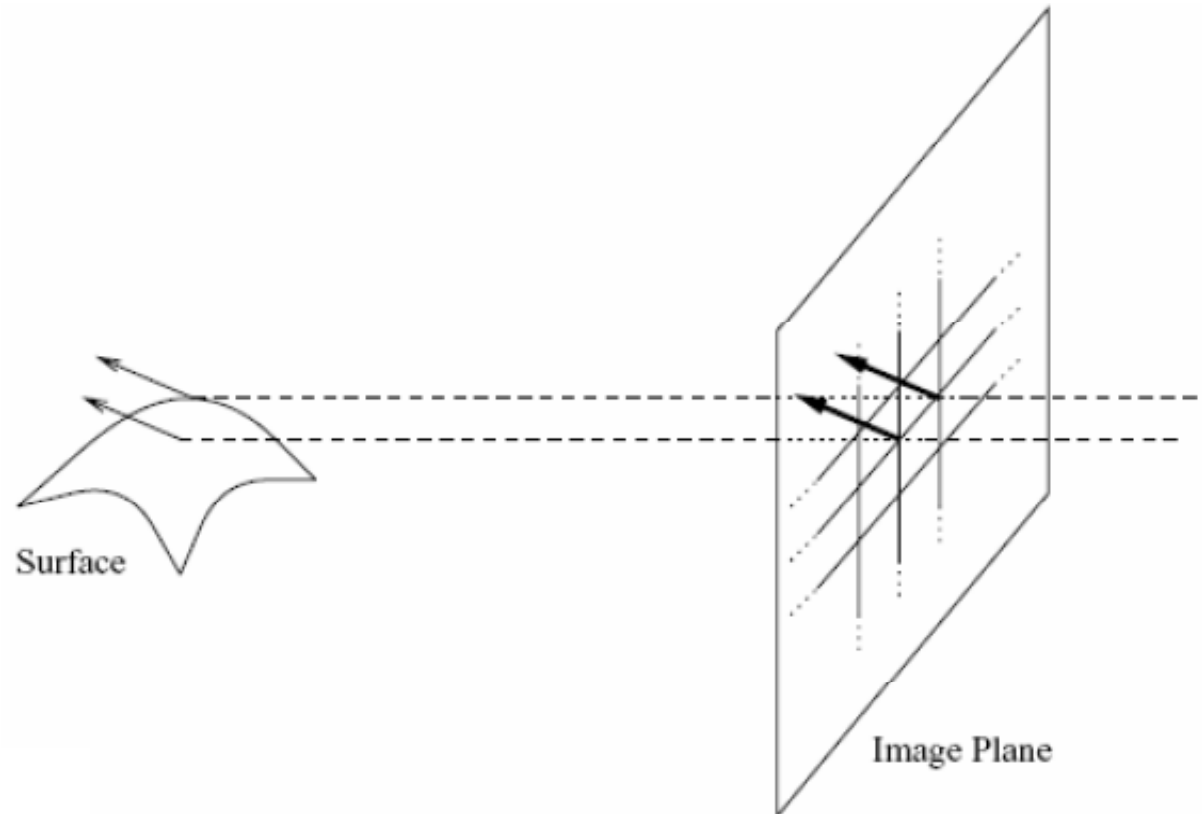

- Neighboring points in the scene typically belong to the same surface and hence typically have similar motions.
- Since they also project to nearby pixels in the image, we expect spatial coherence in image flow.

Formalize this Idea

Noisy 1D signal:



Noisy measurements $u(x)$

Regularization

Find the “best fitting” smoothed function $v(x)$

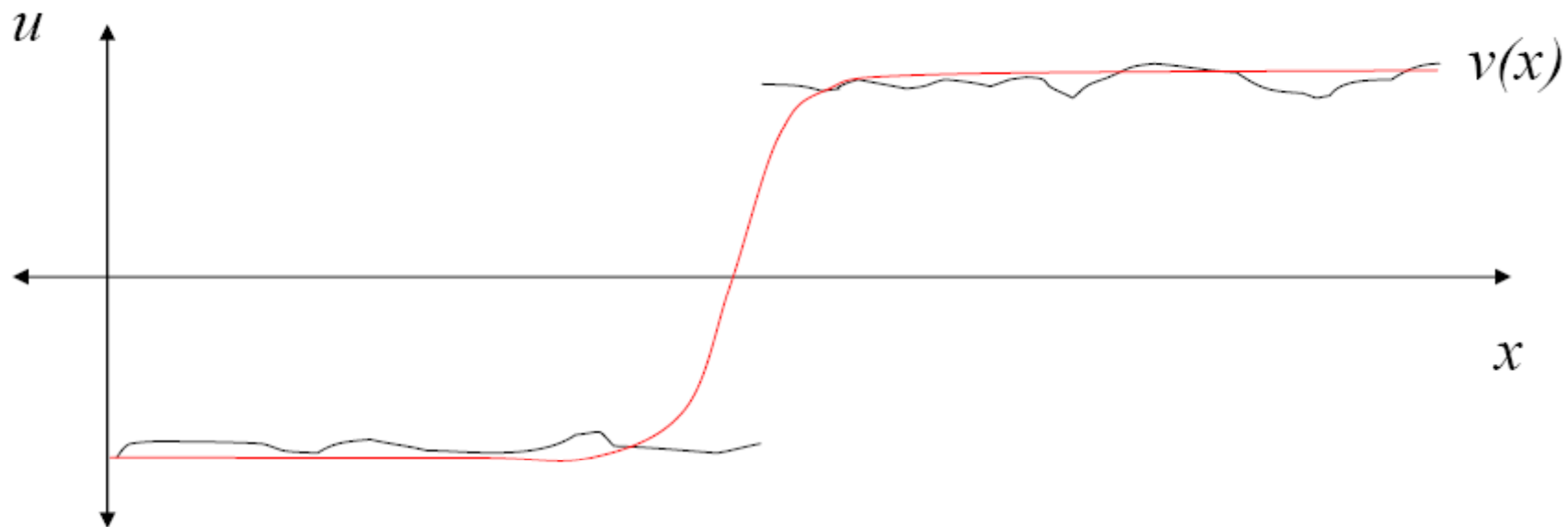

Noisy measurements $u(x)$

Regularization

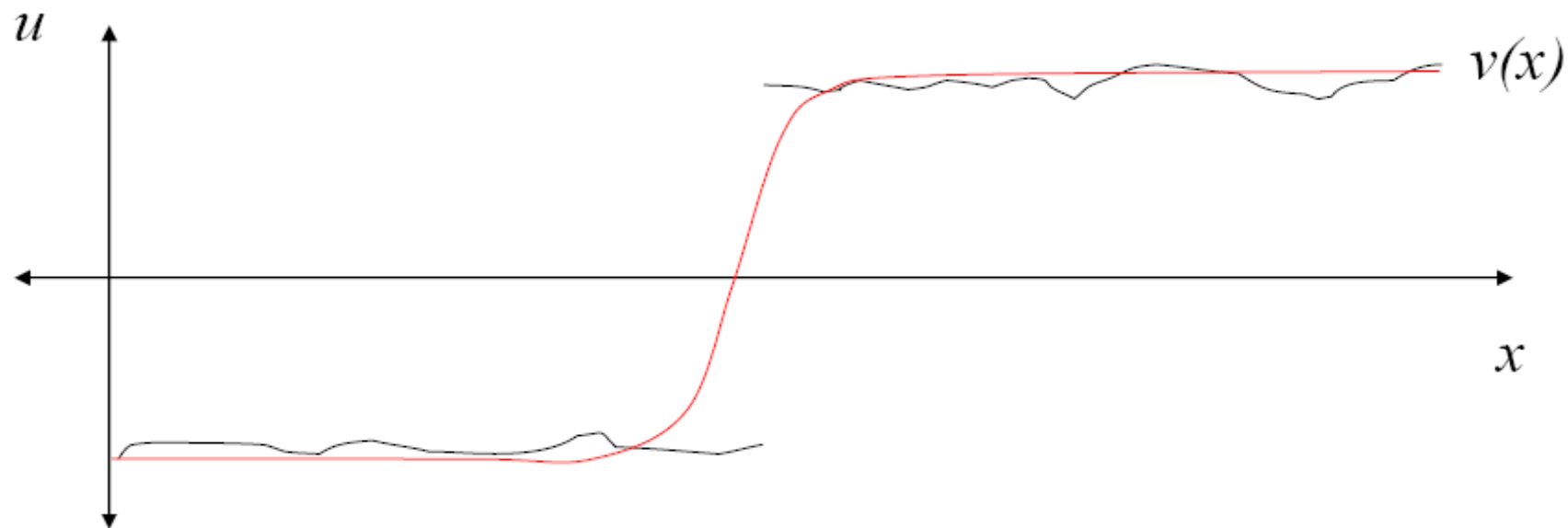

Minimize:

Faithful to the data

Spatial smoothness
assumption

$$E(v) = \sum_{x=1}^N (v(x) - u(x))^2 + \lambda \sum_{x=1}^{N-1} (v(x+1) - v(x))^2$$

Discontinuities

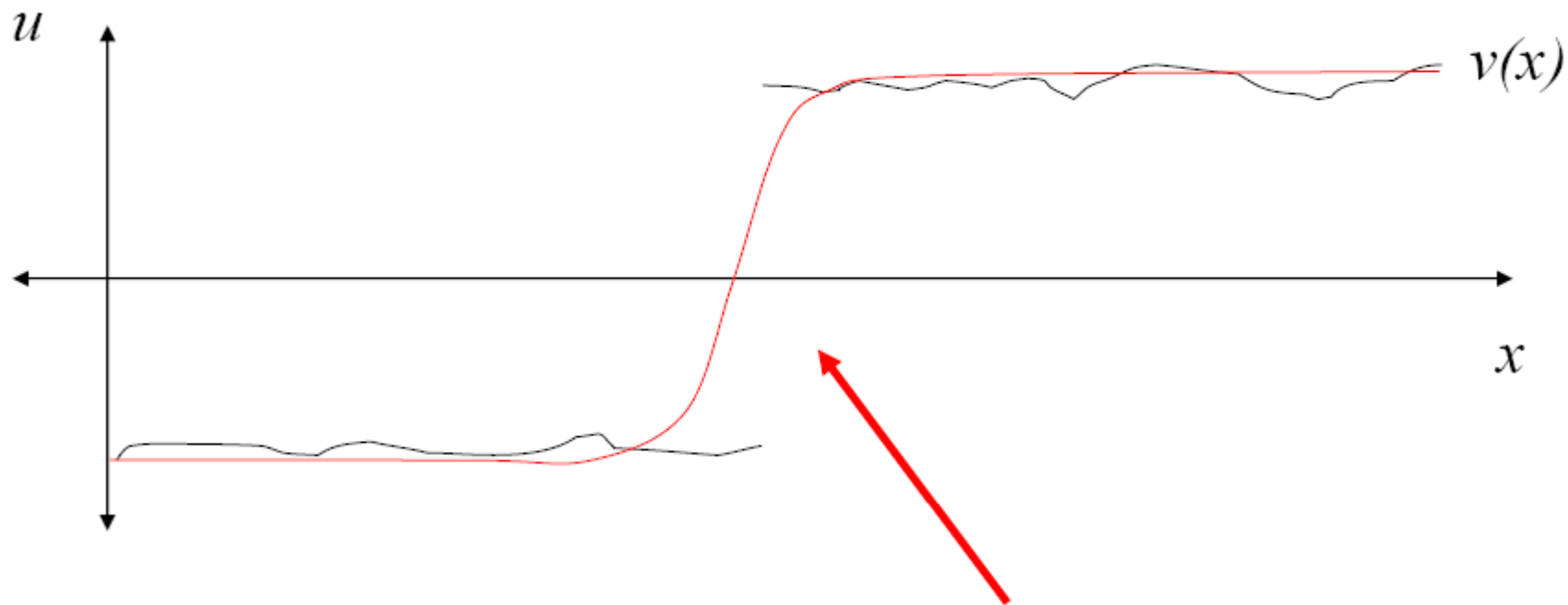

What about this discontinuity?
What is happening here?
What can we do?

Robust Regularization

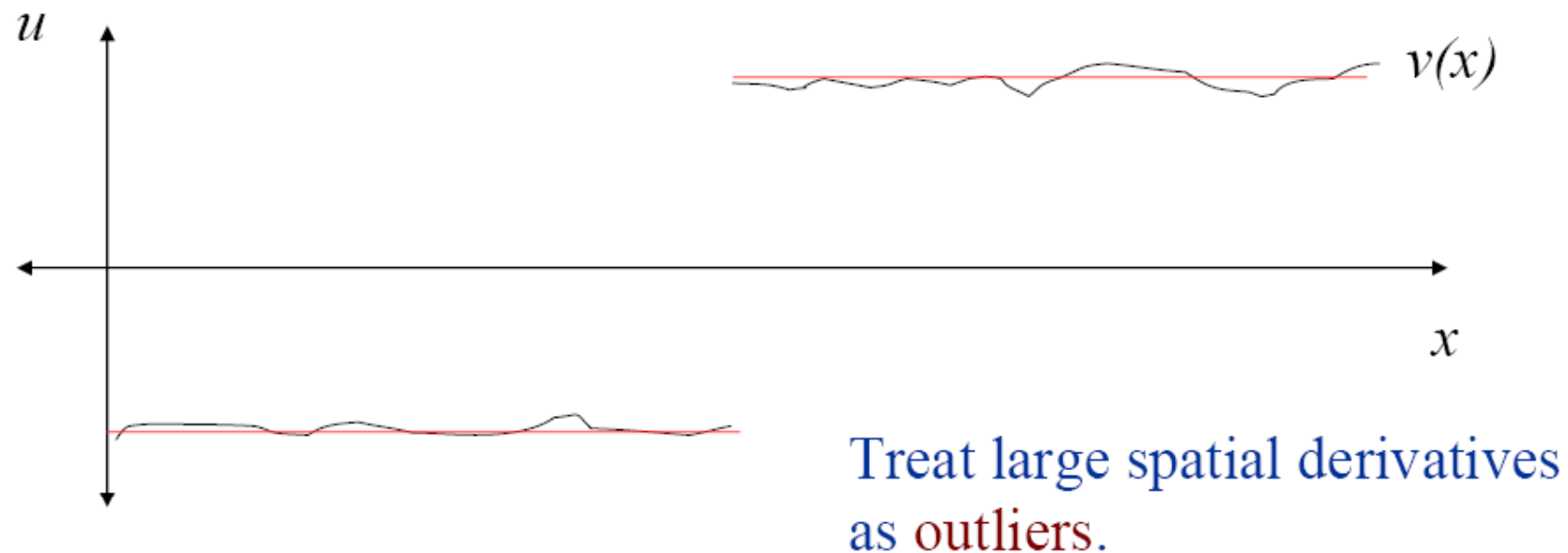

Minimize:

$$E(v) = \sum_{x=1}^N \rho(v(x) - u(x), \sigma_1) + \lambda \sum_{x=1}^{N-1} \rho(v(x+1) - v(x), \sigma_2)$$

“Dense” Optical Flow

$$E_D(\mathbf{u}(\mathbf{x})) = \rho(I_x(\mathbf{x})u(\mathbf{x}) + I_y(\mathbf{x})v(\mathbf{x}) + I_t(\mathbf{x}), \sigma_D)$$

$$E_S(u, v) = \sum_{\mathbf{y} \in G(\mathbf{x})} [\rho(u(\mathbf{x}) - u(\mathbf{y}), \sigma_S) + \rho(v(\mathbf{x}) - v(\mathbf{y}), \sigma_S)]$$

Objective function:

$$E(\mathbf{u}) = \sum_{\mathbf{x}} E_D(\mathbf{u}(\mathbf{x})) + \lambda E_S(\mathbf{u}(\mathbf{x}))$$

When ρ is quadratic = “Horn and Schunck”

Example

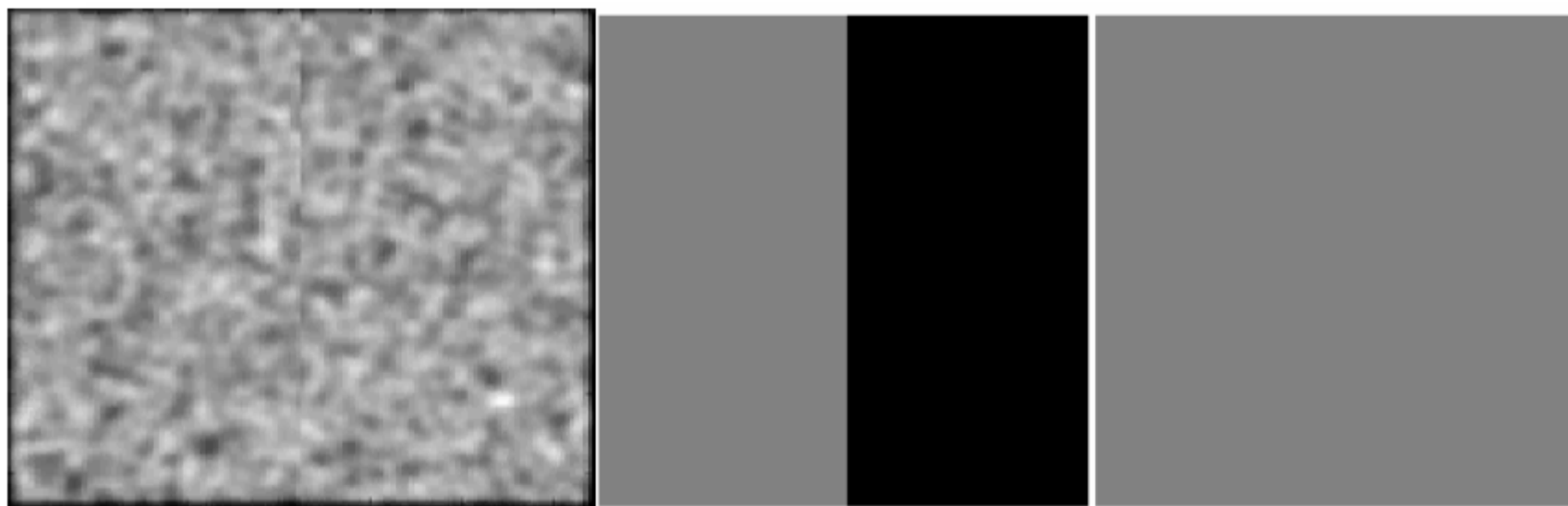

Input image

Horizontal
motion

Vertical
motion

Quadratic:

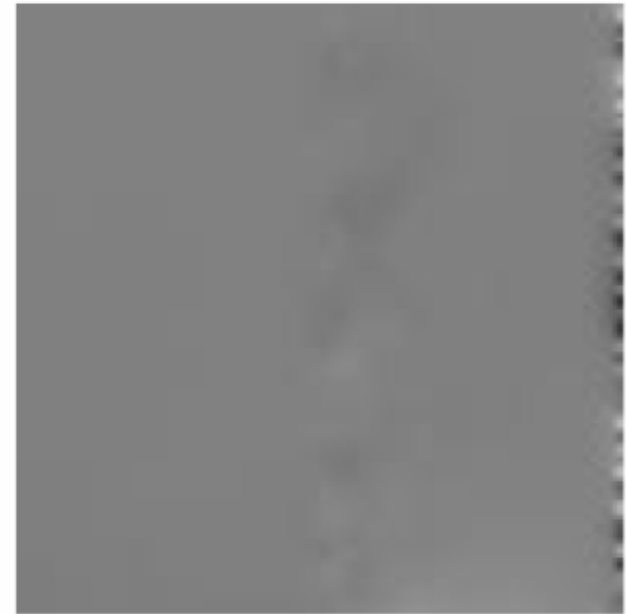

Robust:



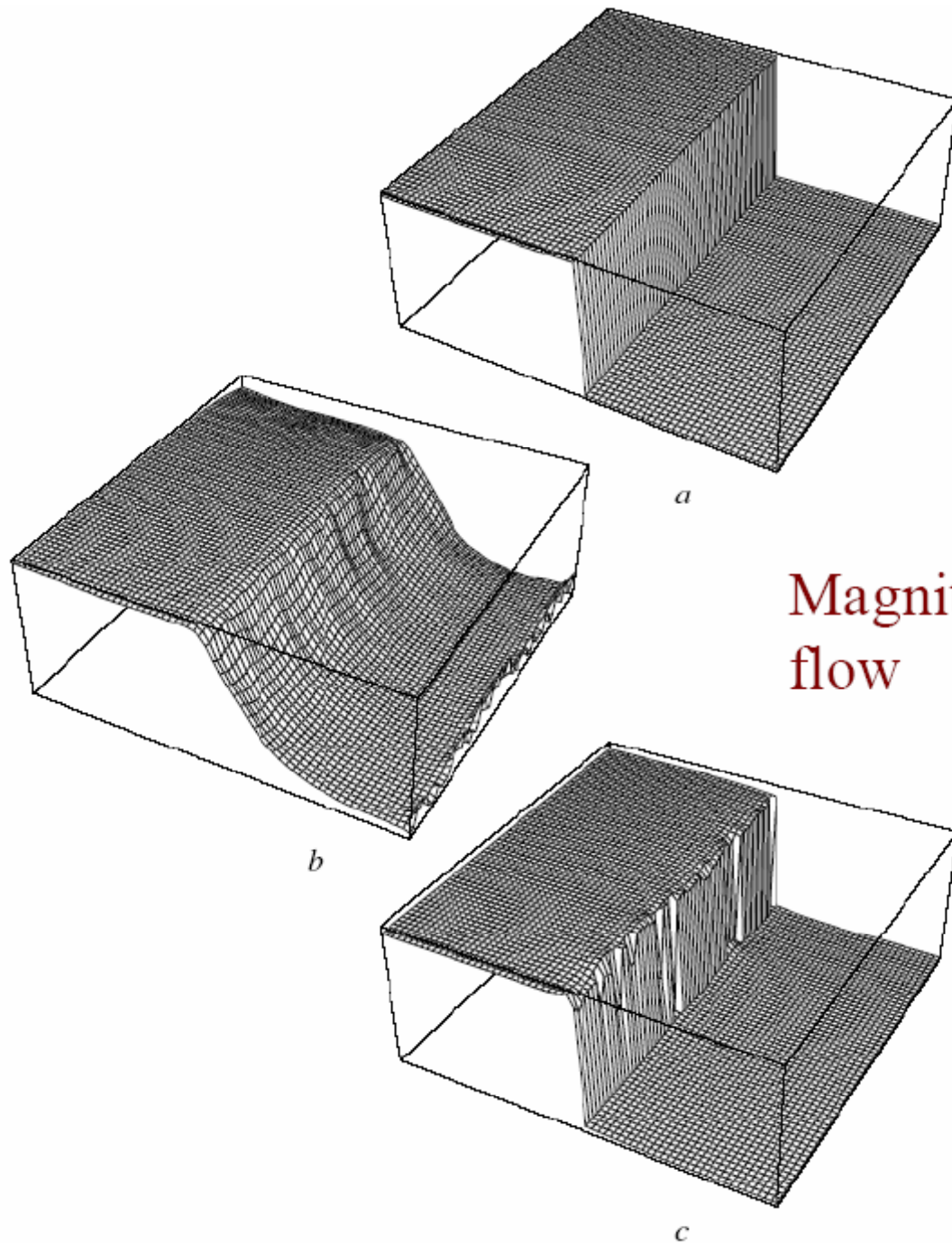

Magnitude of horizontal
flow

Application of optical flow

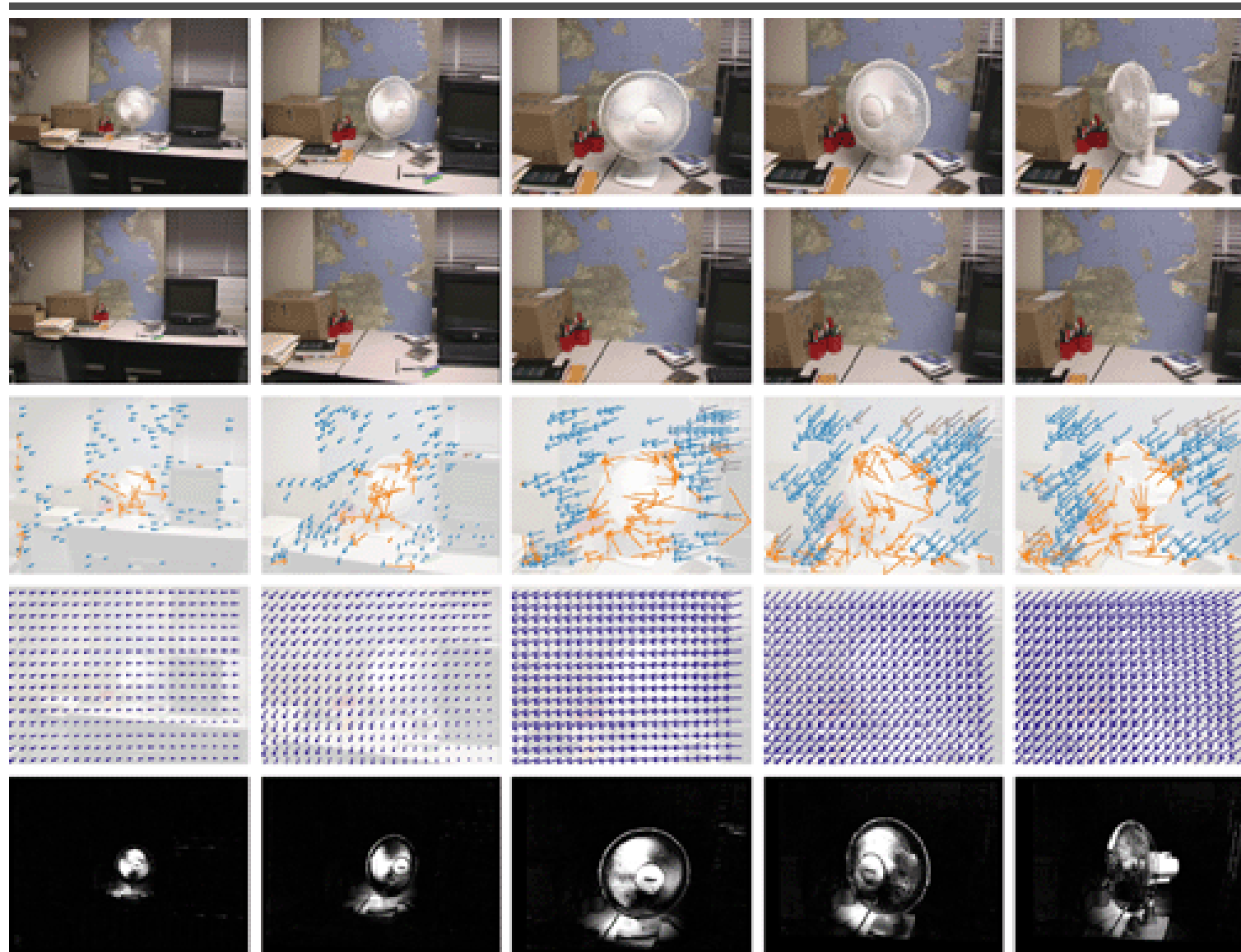

video
matching

Applications of Optical Flow

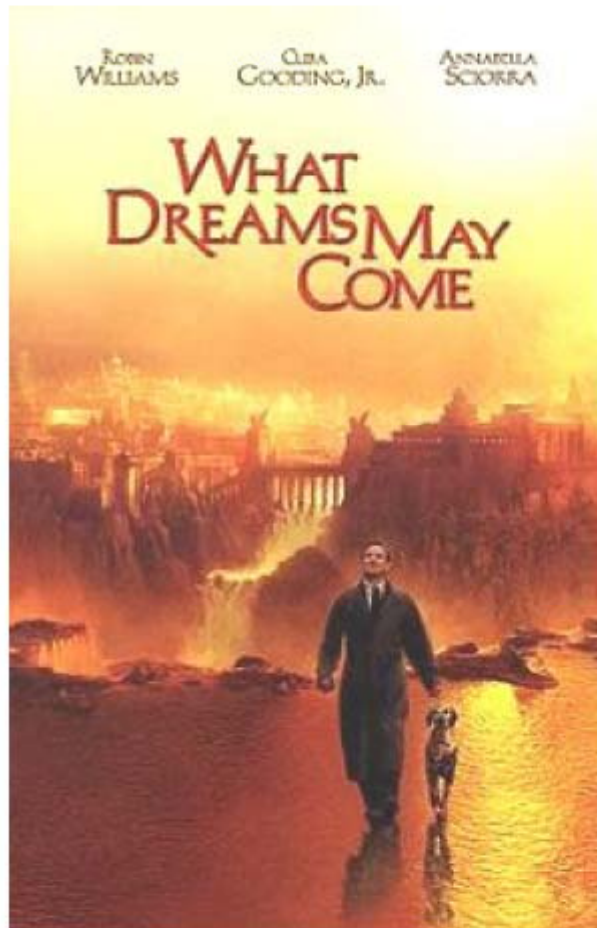

Impressionist effect.
Transfer motion of real world to a painting

Input for the NPR algorithm



Brushes



Edge clipping



Gradient



Smooth gradient



Textured brush



Edge clipping

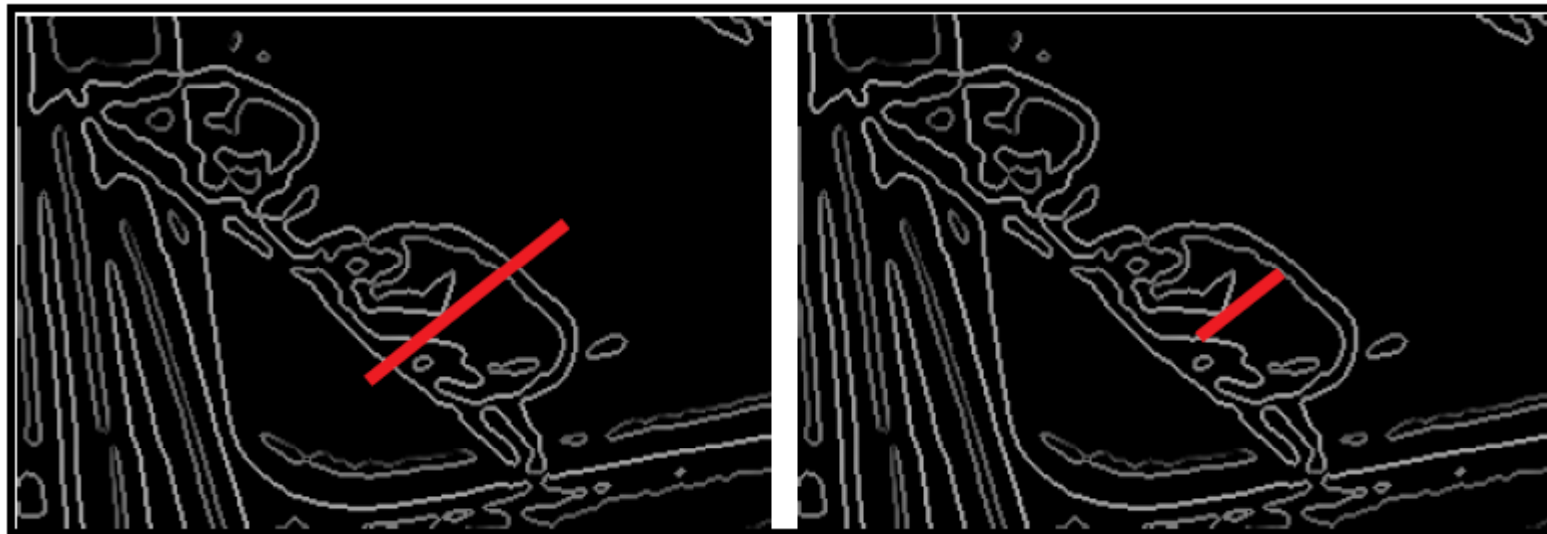

Temporal artifacts



Frame-by-frame application of the NPR algorithm

Temporal coherence

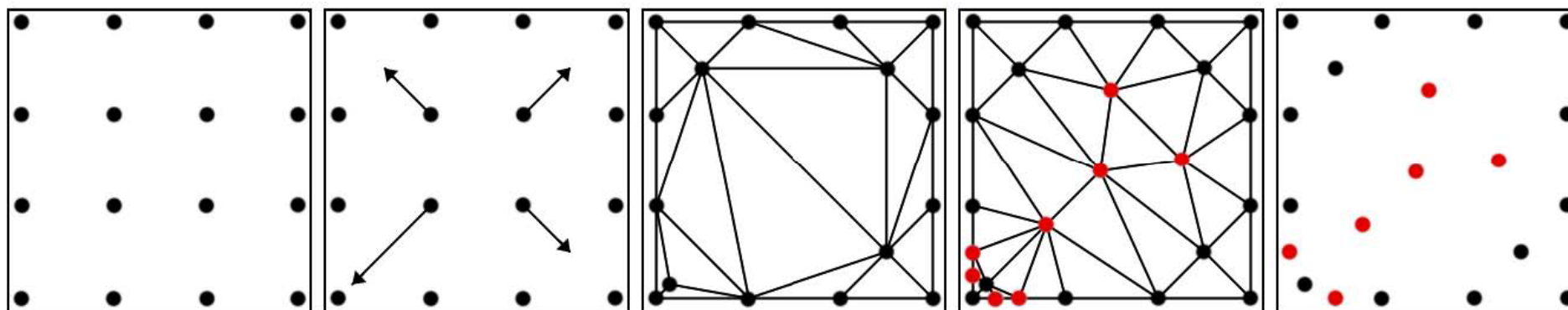

References

- B.D. Lucas and T. Kanade, [An Iterative Image Registration Technique with an Application to Stereo Vision](#), Proceedings of the 1981 DARPA Image Understanding Workshop, 1981, pp121-130.
- Bergen, J. R. and Anandan, P. and Hanna, K. J. and Hingorani, R., [Hierarchical Model-Based Motion Estimation](#), ECCV 1992, pp237-252.
- J. Shi and C. Tomasi, [Good Features to Track](#), CVPR 1994, pp593-600.
- Michael Black and P. Anandan, [The Robust Estimation of Multiple Motions: Parametric and Piecewise-Smooth Flow Fields](#), Computer Vision and Image Understanding 1996, pp75-104.
- S. Baker and I. Matthews, [Lucas-Kanade 20 Years On: A Unifying Framework](#), International Journal of Computer Vision, 56(3), 2004, pp221 - 255.
- Peter Litwinowicz, [Processing Images and Video for An Impressionist Effects](#), SIGGRAPH 1997.
- Aseem Agarwala, Aaron Hertzman, David Salesin and Steven Seitz, [Keyframe-Based Tracking for Rotoscoping and Animation](#), SIGGRAPH 2004, pp584-591.