



視覺密碼 Visual Cryptography

陳琨

kchen@csie.org

密碼學 Cryptography

- 源於希臘文 “kryptós” 「隱藏」，和 “gráphein” 「寫字」組成，表示隱藏的字

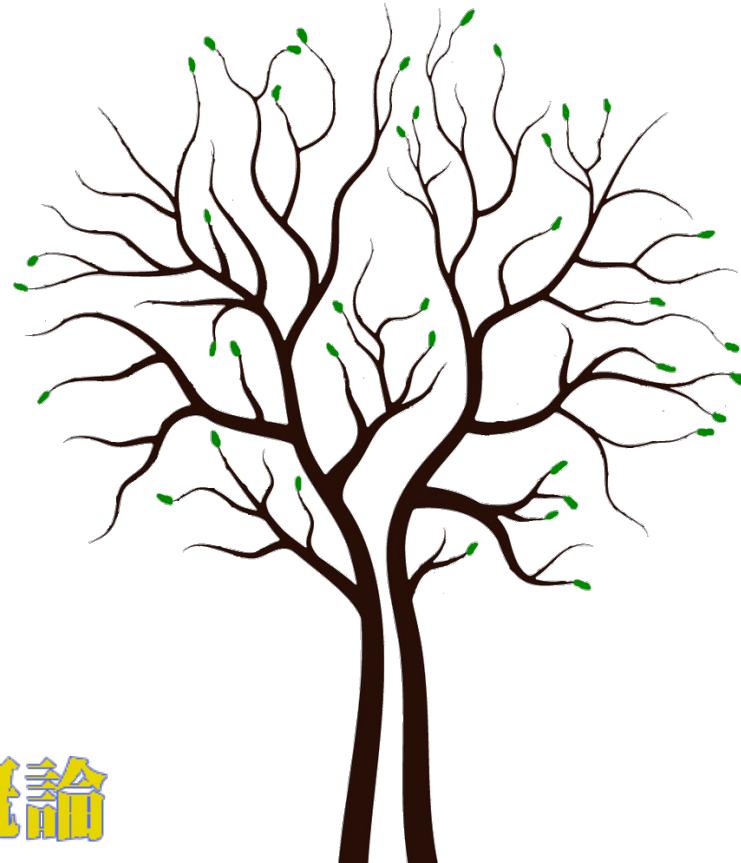

凱撒(Caesar)密碼

- 於西元前50年羅馬皇帝 Julius Caesar 使用
- 將每個字母用其後的第三個字母來取代。

– 明文 : i love you

– 密文 : l oryh brx

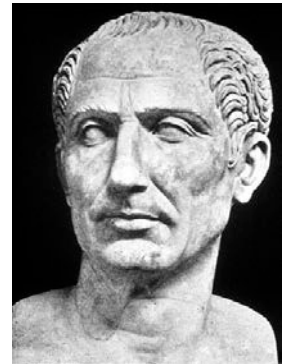
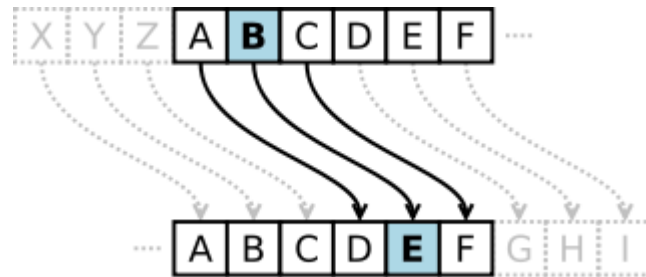

$$C = E_n(P) = (P + n) \bmod 26$$

$$P = D_n(C) = (C - n) \bmod 26$$



福爾摩斯與跳舞的人

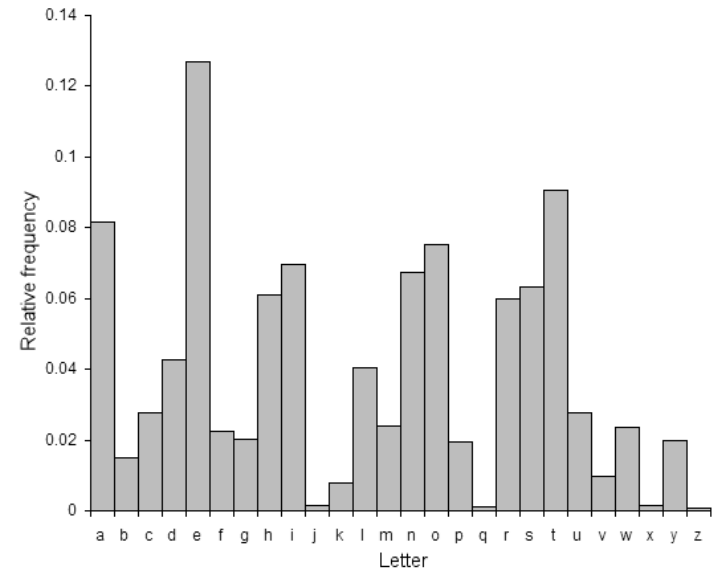
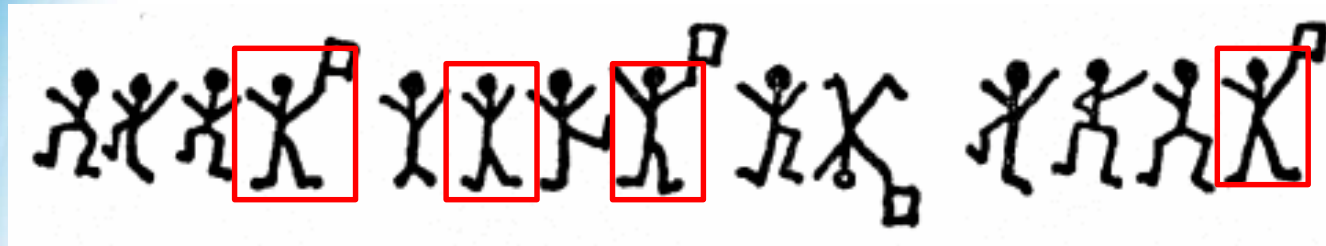

福爾摩斯與跳舞的人

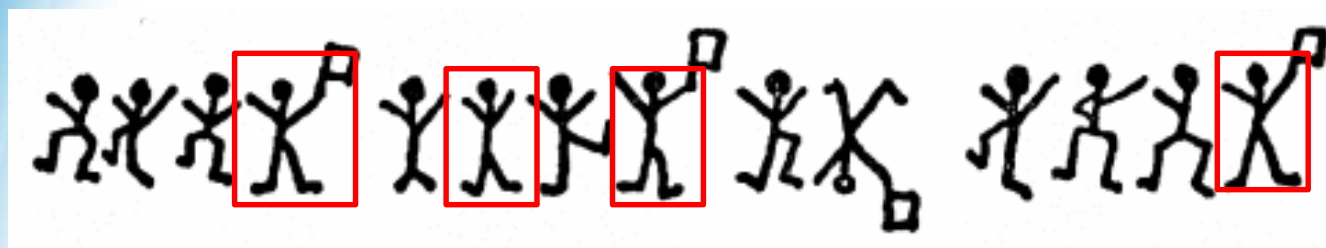

C O M E H E R E A T O N C E

A	B	C	D	E	F	G	H	I	J	K	L	M



資料加密標準 (DES)

- DES : Data Encryption Standard

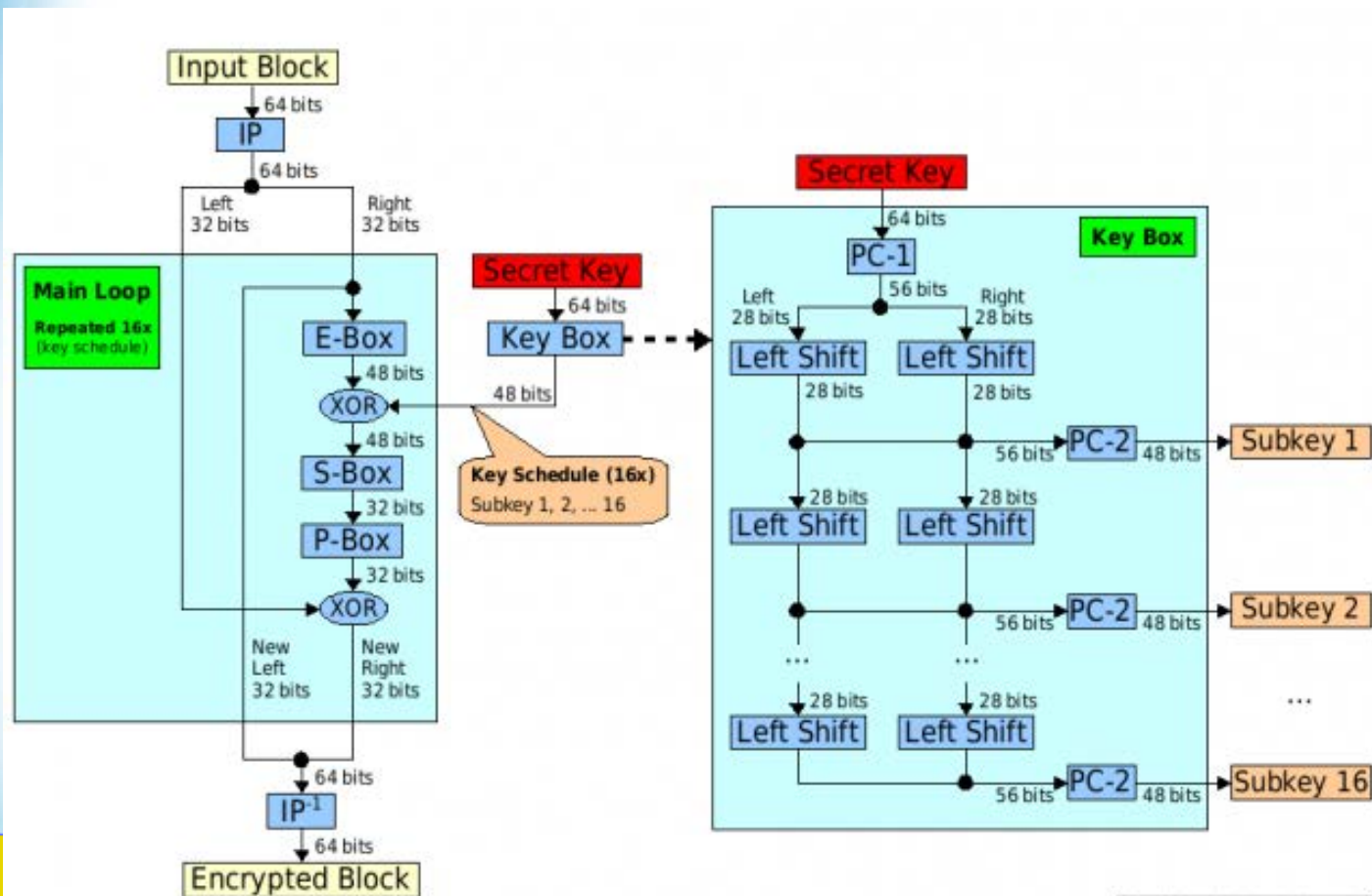

現今密碼應用



One-time pad

- 稱**一次性密碼本**，是一種加密的演算法
- 特性：金鑰是**隨機產生且只用一次**
- 夏農 (Shannon)於1948年證明此種加密是俱有完美的安全性(perfect security)，亦即猜金鑰的機率和猜明文的機率是一樣。

明文：01101001 01110110
金鑰：01100101 01111000
密文：00001100 00001110

XOR

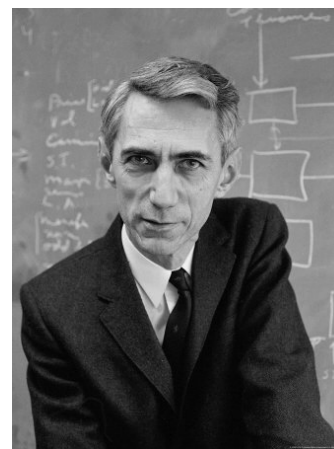
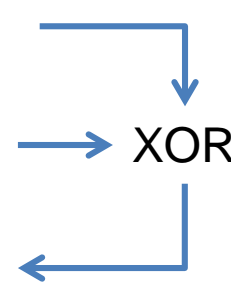

1916-2001



XOR 的秘密

XOR	0	1
0	0	1
1	1	0

OR	0	1
0	0	1
1	1	1

AND	0	1
0	0	0
1	0	1



用OR模擬XOR

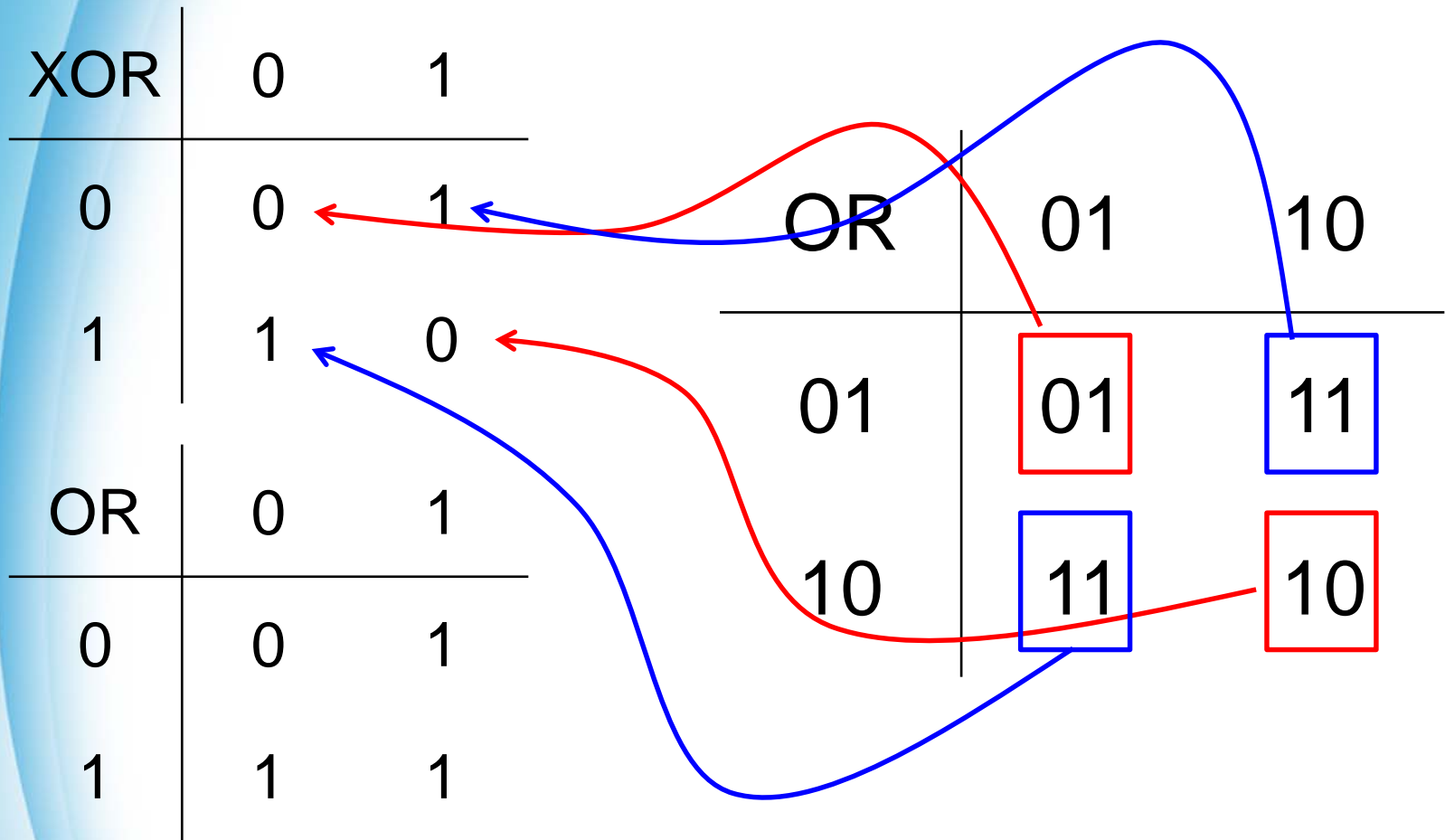

視覺密碼

- 1995年由 Naor 和 Shamir 所提出
- 不同於傳統的密碼學，在於解密時不需要任何的計算，直接利用人的眼睛即可看的出機密

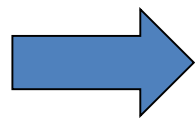

解密

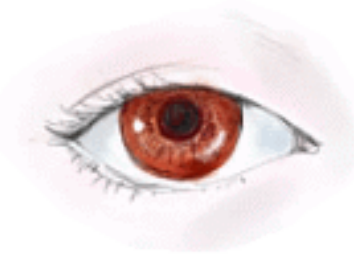



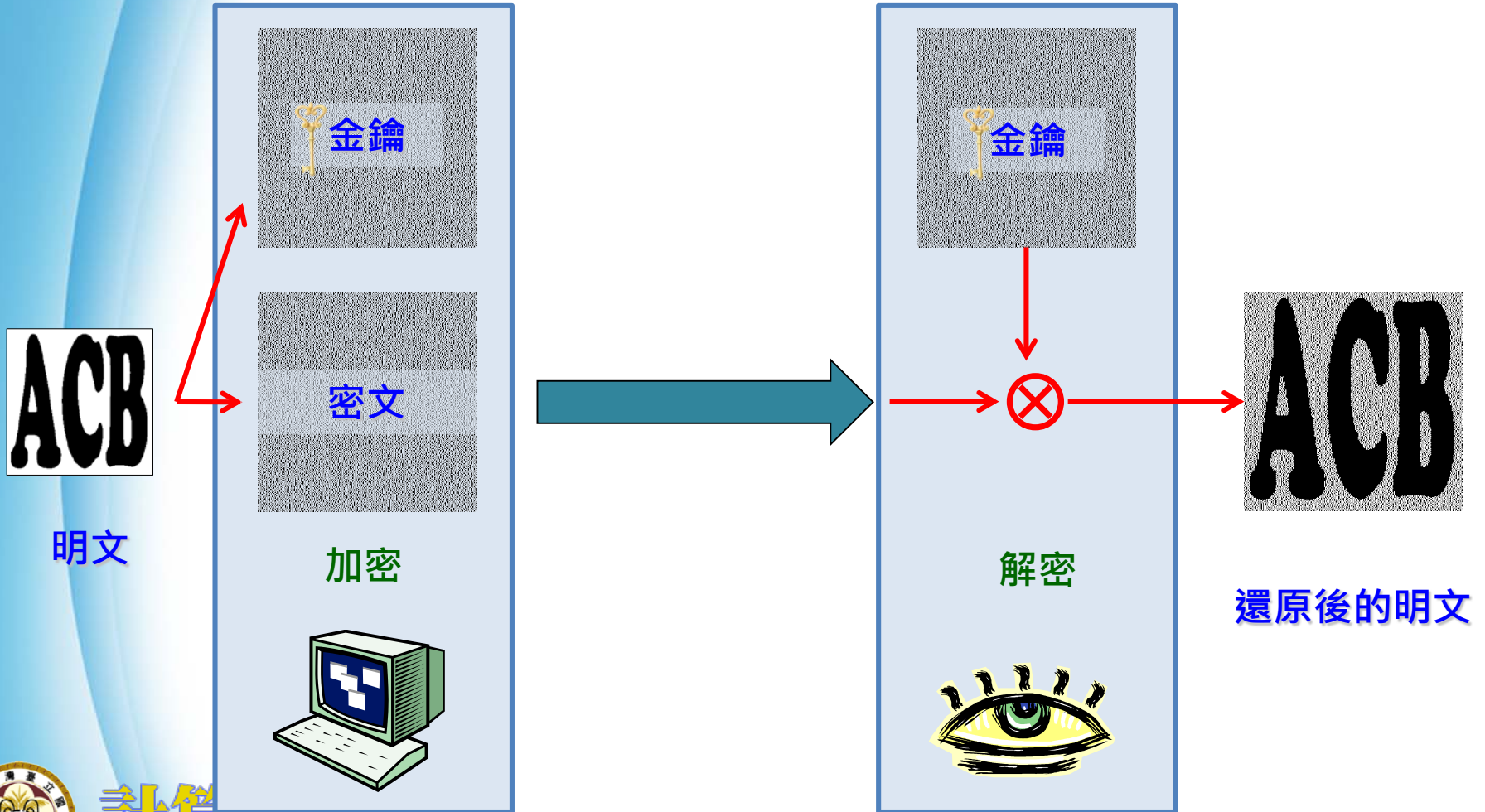





視覺密碼的流程











投影片的效果

OR	0	1
0	0	1
1	1	1











疊合		
		
		

模擬	01	10
01	01	11
10	11	10

疊合		
		
		

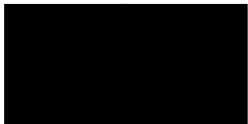

編碼表

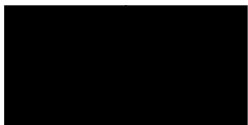
p	s_1	s_2	$s_1 + s_2$
□			
			
■			
			



視覺密碼的例子

p	s_1	s_2	s_1+s_2
□			
■			

codebook

機密影像

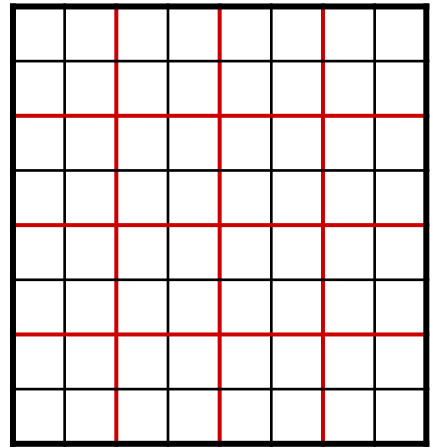
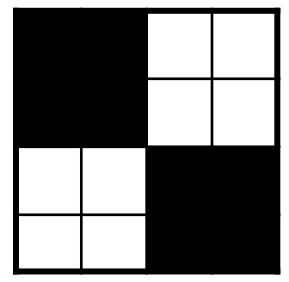

S_1

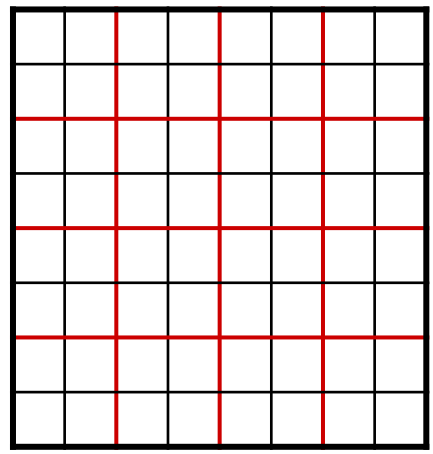

S_2



視覺密碼的例子

p	s_1	s_2	s_1+s_2
□			
■			

codebook

機密影像

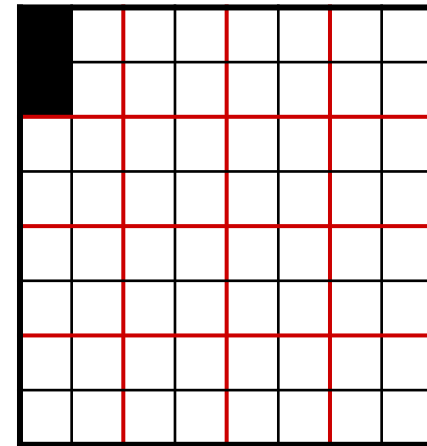
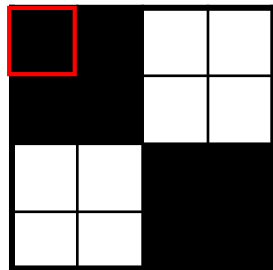



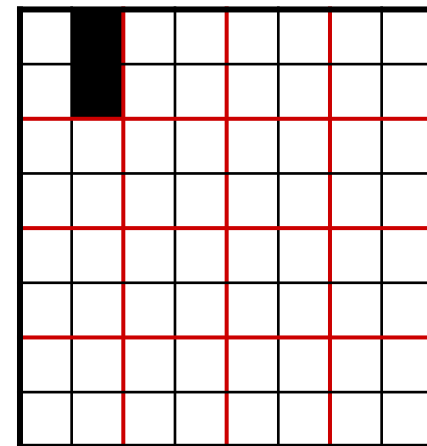













S_1



S_2



視覺密碼的例子

p	s_1	s_2	s_1+s_2
			
			
			
			

codebook

機密影像

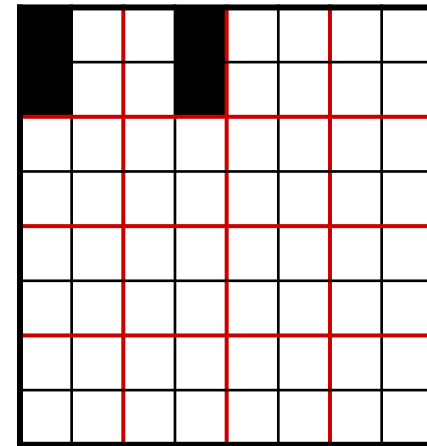
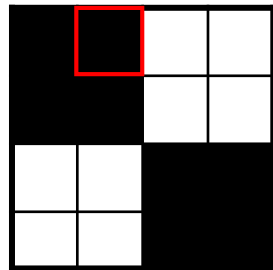



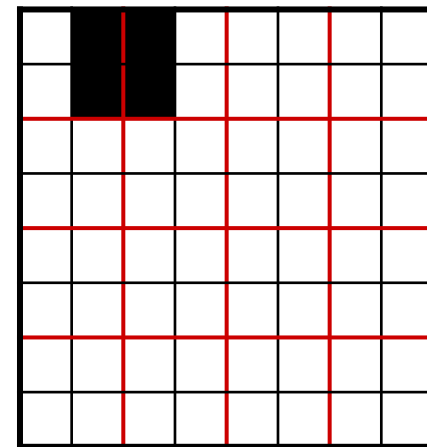













S_1



S_2



視覺密碼的例子

p	s_1	s_2	s_1+s_2
			
			
			
			
			

codebook

機密影像

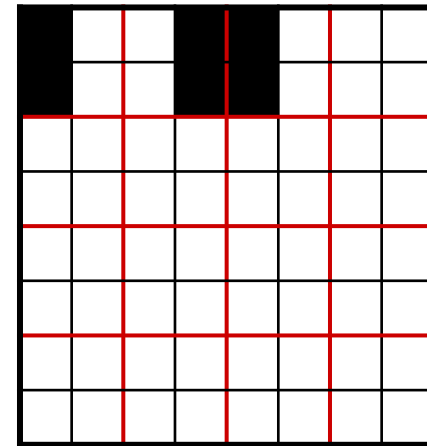
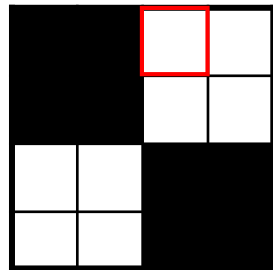



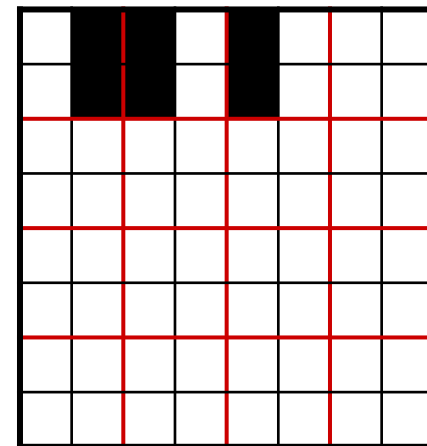











S_1



S_2



視覺密碼的例子

p	s_1	s_2	s_1+s_2
			
			
			
			

codebook

機密影像

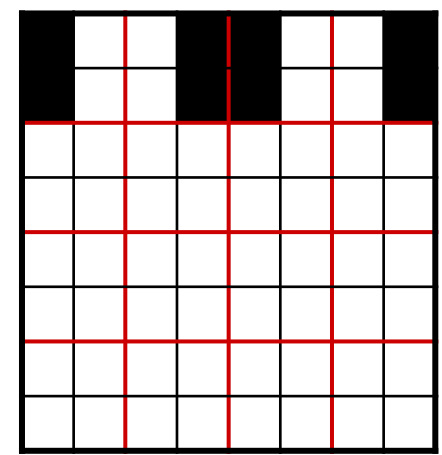
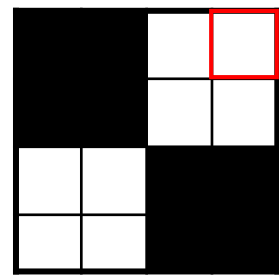



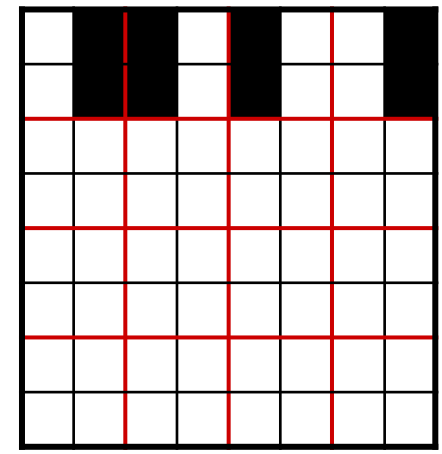













S_1



S_2



視覺密碼的例子

p	s_1	s_2	s_1+s_2
			
			
			
			
			

codebook

機密影像

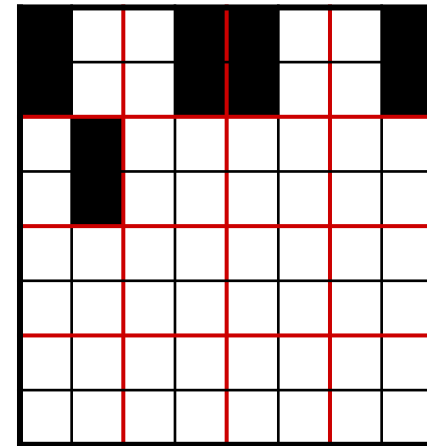
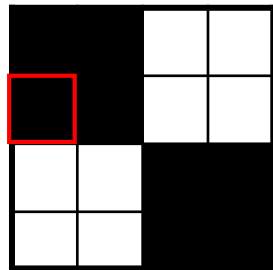

S_1

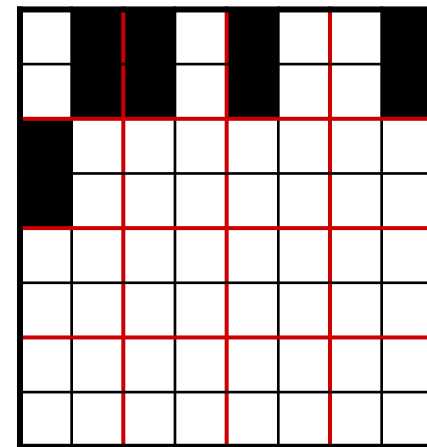

S_2



視覺密碼的例子

p	s_1	s_2	s_1+s_2
□			
■			

codebook

機密影像

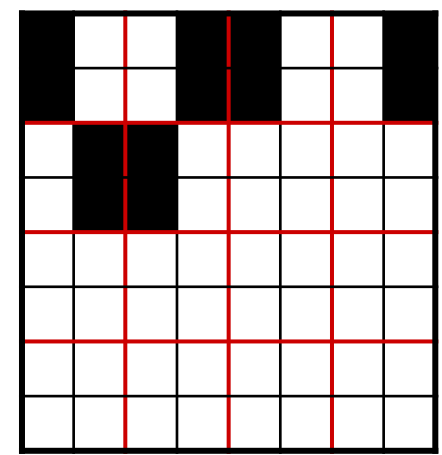
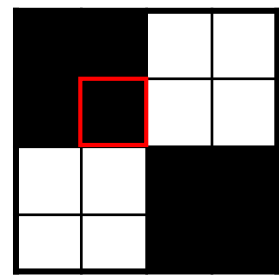



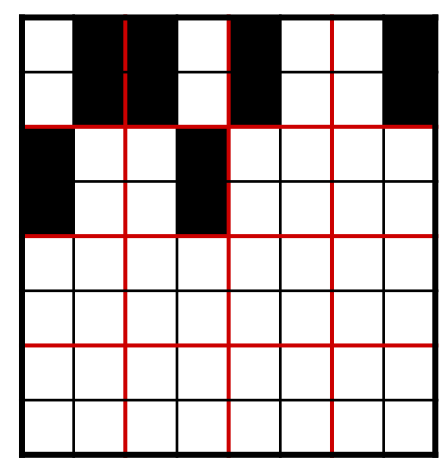











S_1



S_2



視覺密碼的例子

p	s_1	s_2	s_1+s_2
			
			
			
			

codebook

機密影像

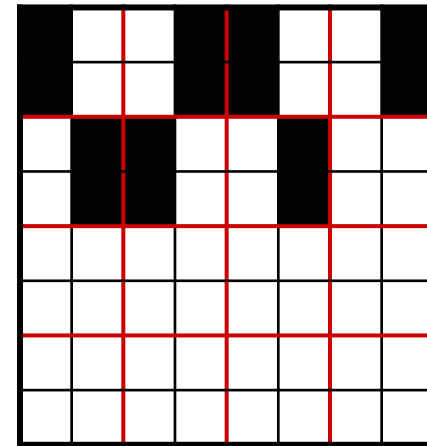
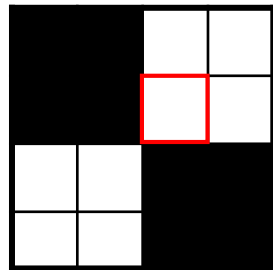



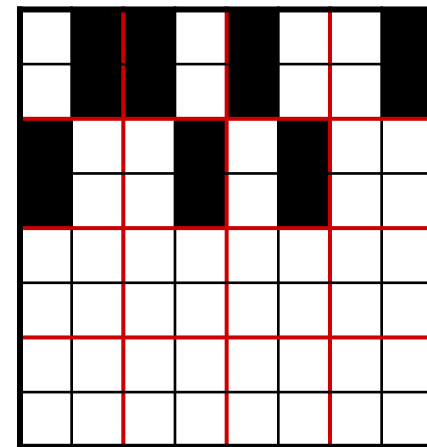



S_1

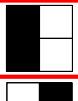
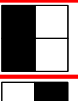
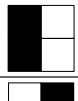

S_2

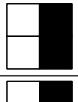
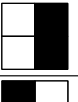
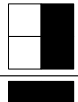
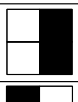
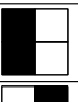

視覺密碼的例子

p	s_1	s_2	s_1+s_2
			
			
			
			

codebook

機密影像

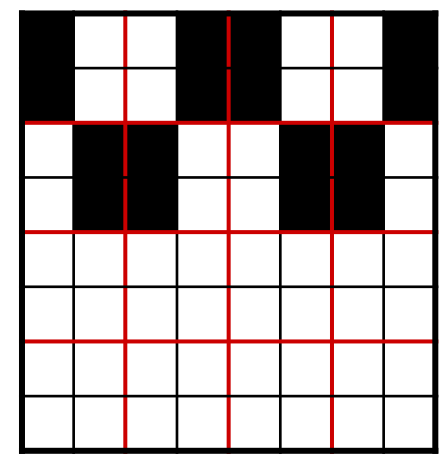
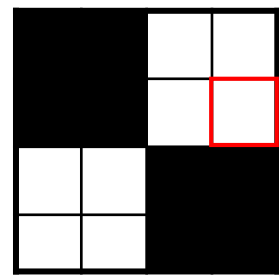



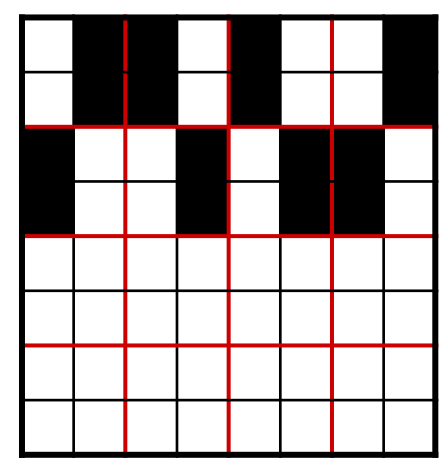











S_1



S_2



視覺密碼的例子

p	s_1	s_2	s_1+s_2
			
			
			
			

codebook

機密影像

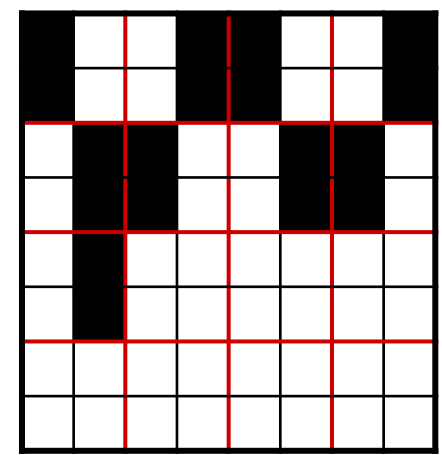
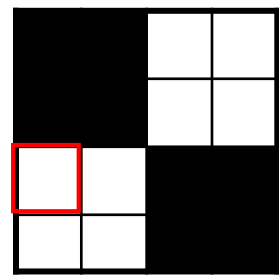

S_1

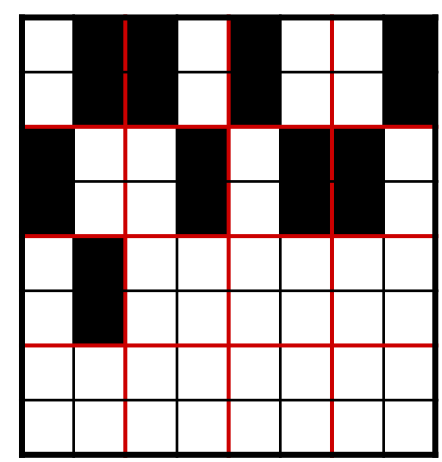

S_2



視覺密碼的例子

p	s_1	s_2	s_1+s_2
□	■ □	■ □	■ □
	□ ■	□ ■	□ ■
■	□ ■	■ □	■ ■
	■ □	□ ■	■ ■

codebook

機密影像

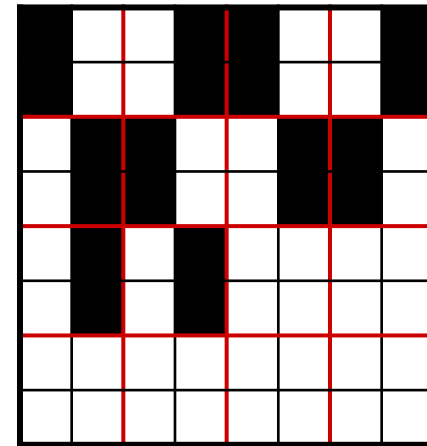
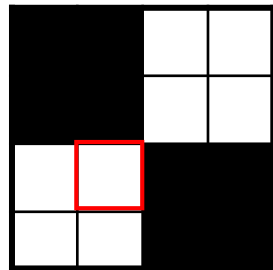

S_1

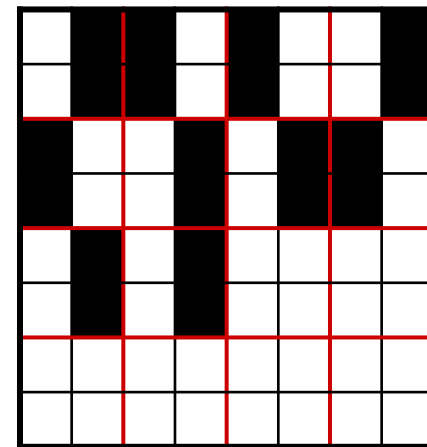

S_2



視覺密碼的例子

p	s_1	s_2	s_1+s_2
□			
■			

codebook

機密影像

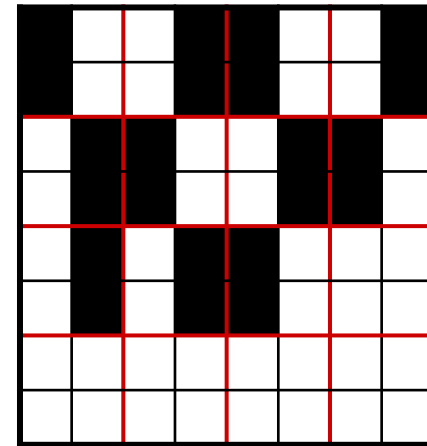
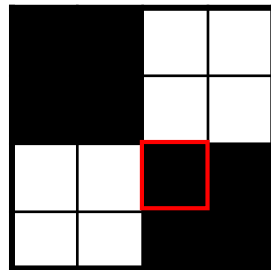

S_1

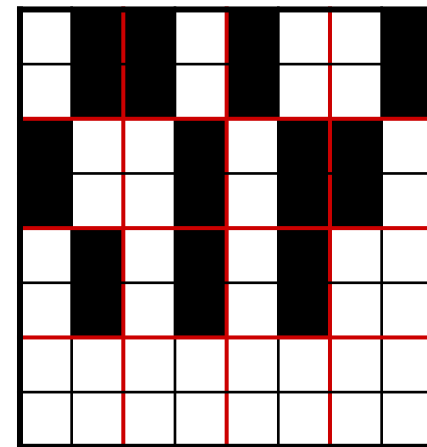

S_2



視覺密碼的例子

p	s_1	s_2	s_1+s_2
□			
■			

codebook

機密影像

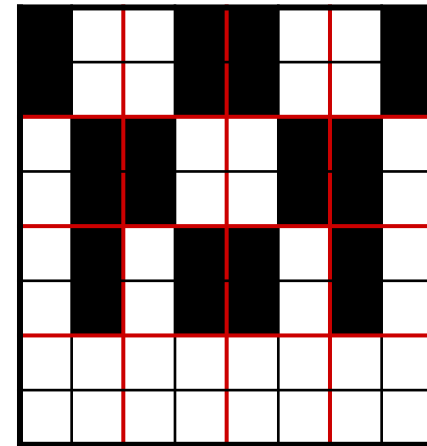
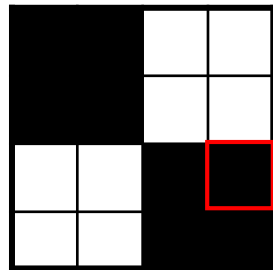



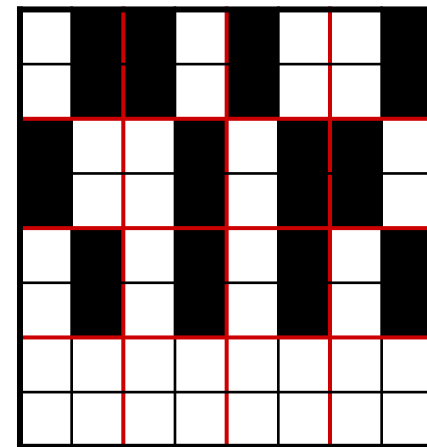











S_1



S_2



視覺密碼的例子

p	s_1	s_2	s_1+s_2
			
			
			
			

codebook

機密影像

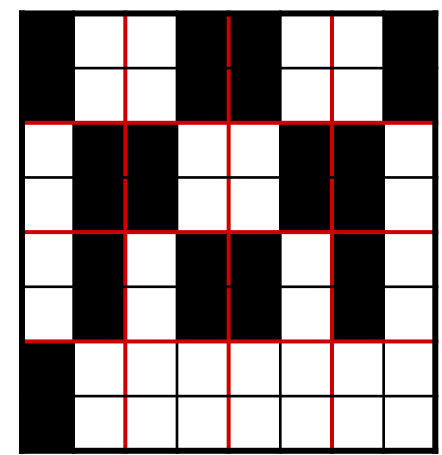
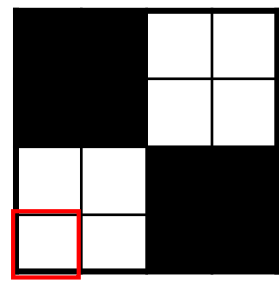

S_1

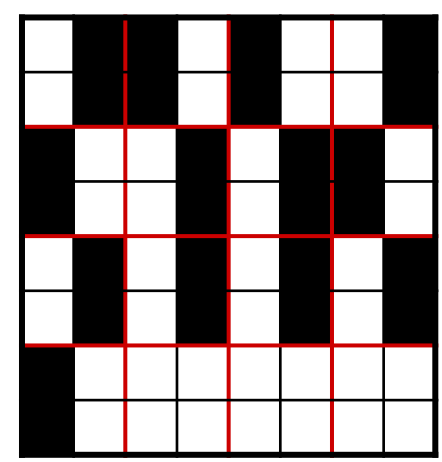

S_2



視覺密碼的例子

p	s_1	s_2	s_1+s_2
□	■ □	■ □	■ □
	□ ■	□ ■	□ ■
■	□ ■	■ □	■ ■
	■ □	□ ■	■ ■

codebook

機密影像

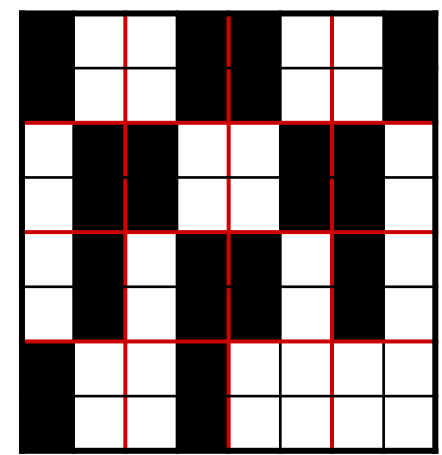
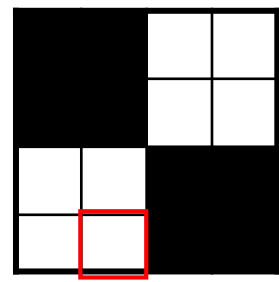

S_1

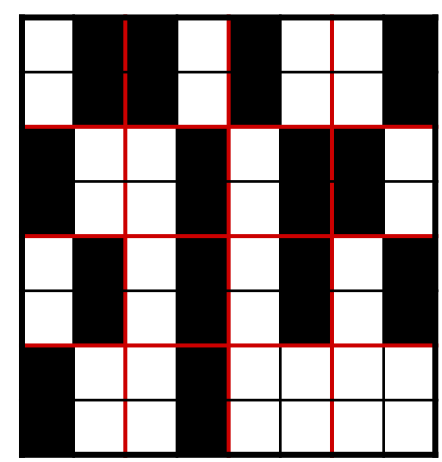

S_2



視覺密碼的例子

p	s_1	s_2	s_1+s_2
□			
■			

codebook

機密影像

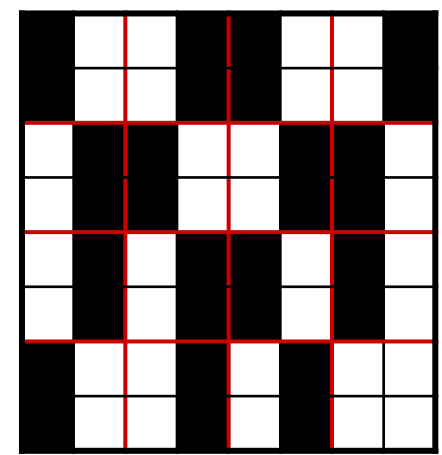
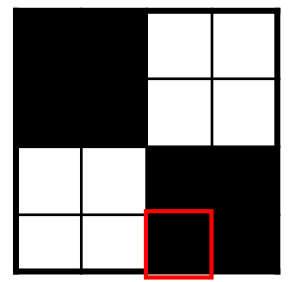

S_1

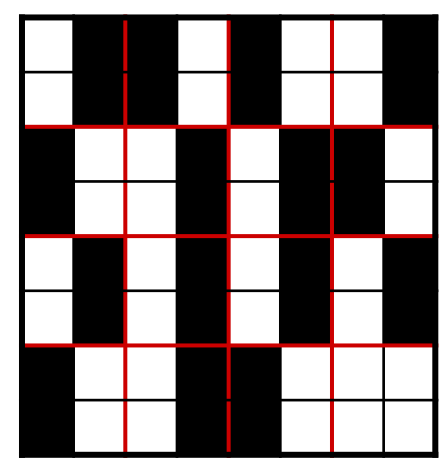

S_2



視覺密碼的例子

p	s_1	s_2	s_1+s_2
□			
■			

codebook

機密影像

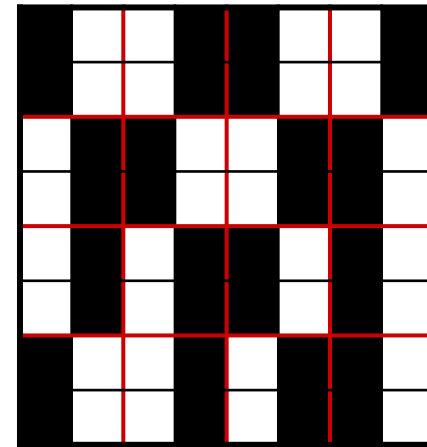
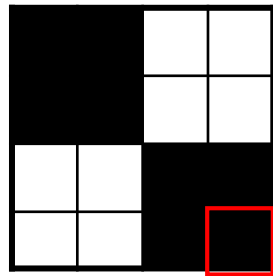

S_1

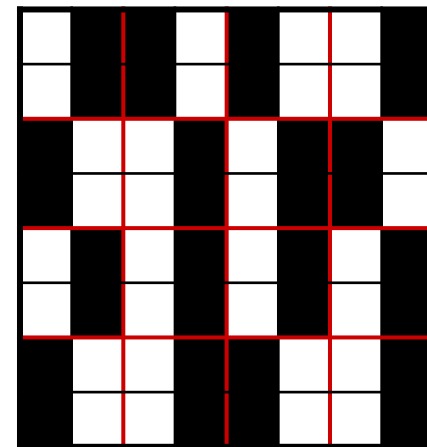

S_2



視覺密碼的例子

p	s_1	s_2	s_1+s_2
□			
■			

codebook

機密影像

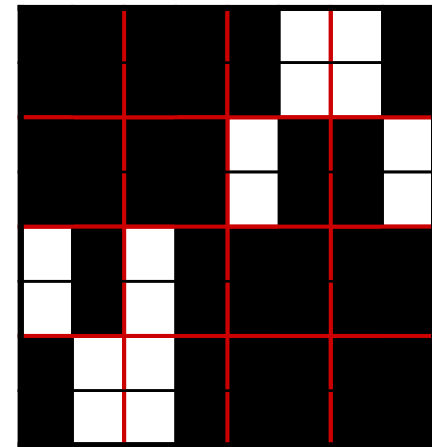
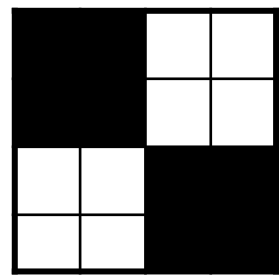

S_1

S_2



視覺機密分享

- $(2, 2)$ 視覺機密分享機制
- (n, n) 視覺機密分享機制
- (k, n) 視覺機密分享機制
- GAS(General Access Structure)視覺機密分享機制



視覺機密分享

- (2, 2) 視覺機密分享機制

- (n, n) 視覺機密分享機制

- (k, n) 視覺機密分享機制

- GAS (General Access Structure) 視覺機密分享機制

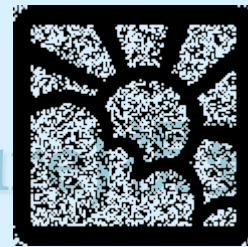
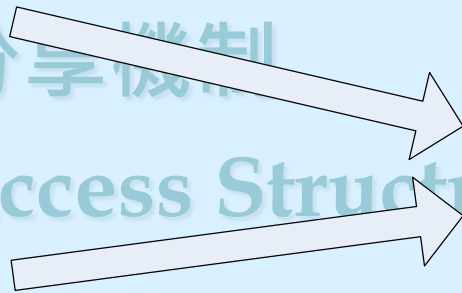
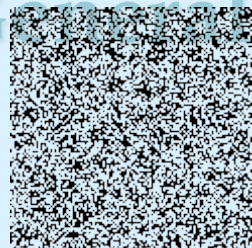
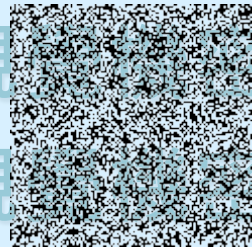

視覺機密分享

- (2, 2) 視覺機密分享機制
- (n, n) 視覺機密分享機制
- (k, n) 視覺機密分享機制
- GAS (General Access Structure) 視覺機密分享機制

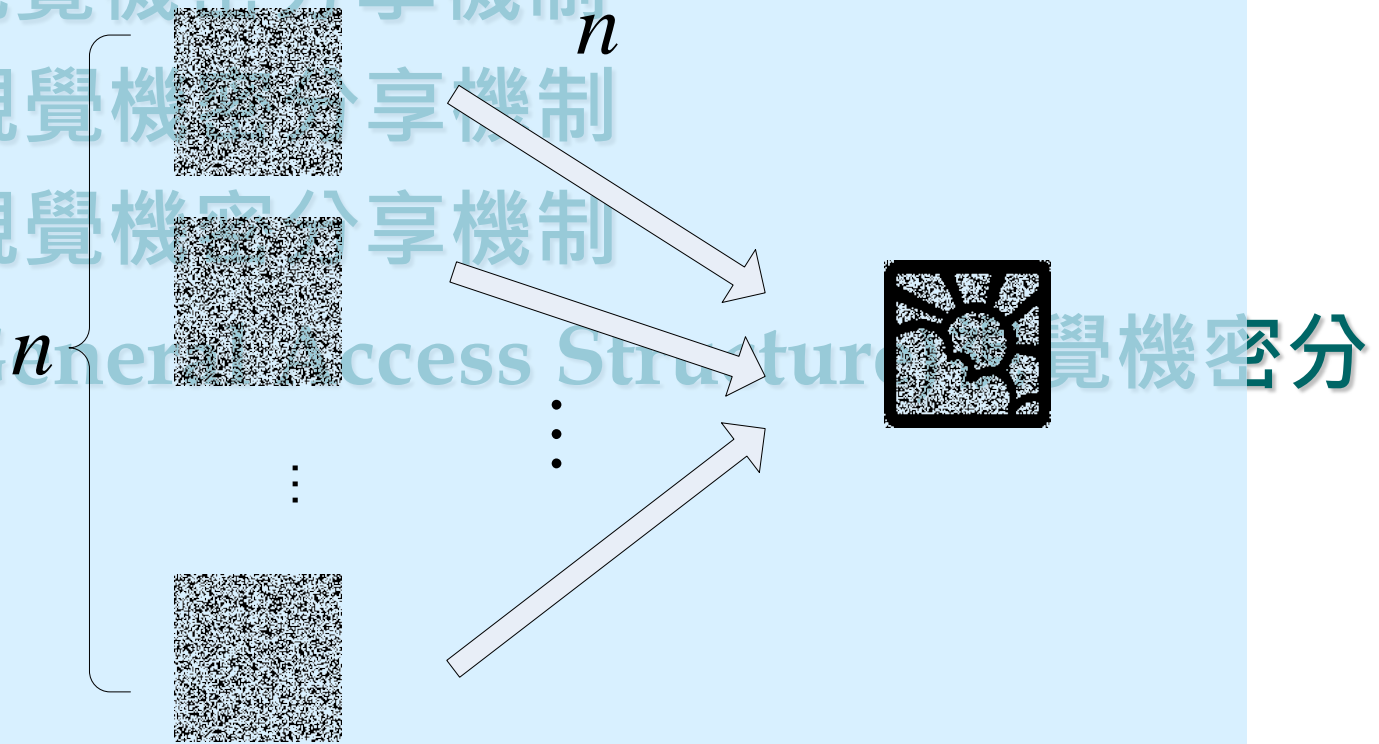

視覺機密分享

- (2, 2) 視覺機密分享機制
- (n, n) 視覺機密分享機制
- (k, n) 視覺機密分享機制
- GAS (General Access Structure) 視覺機密分享機制

n

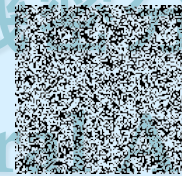
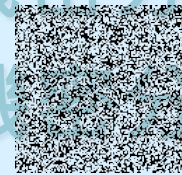

⋮

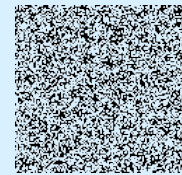

k



$k \leq n$



視覺機密分

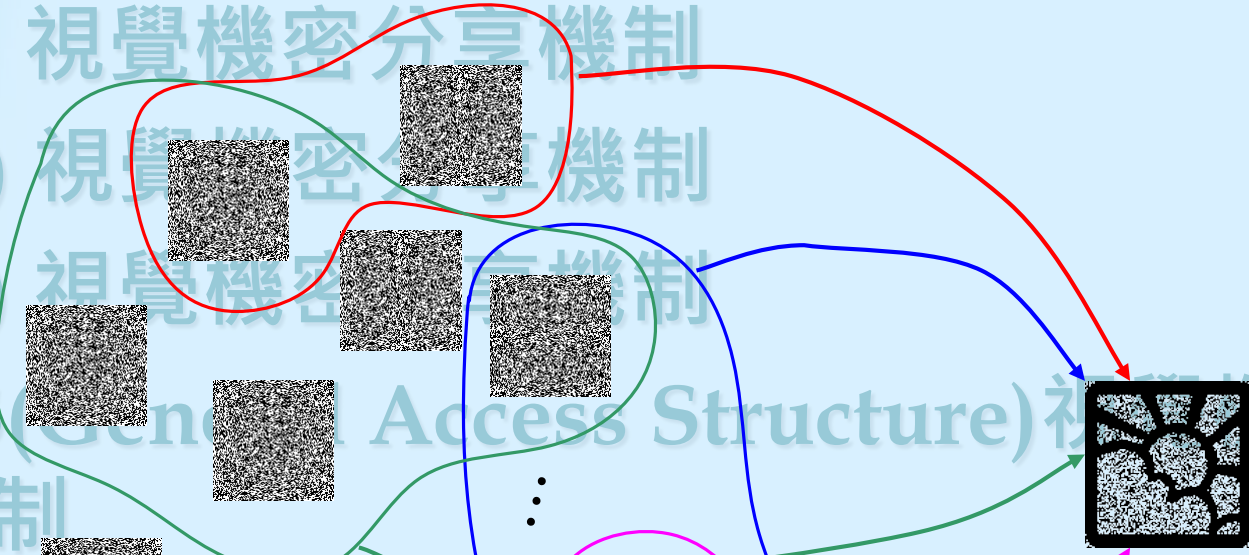

視覺機密分享

- $(2, 2)$ 視覺機密分享機制
 - (n, n) 視覺機密分享機制
 - (k, n) 視覺機密分享機制
 - GAS (General Access Structure) 視覺機密分享機制
- 



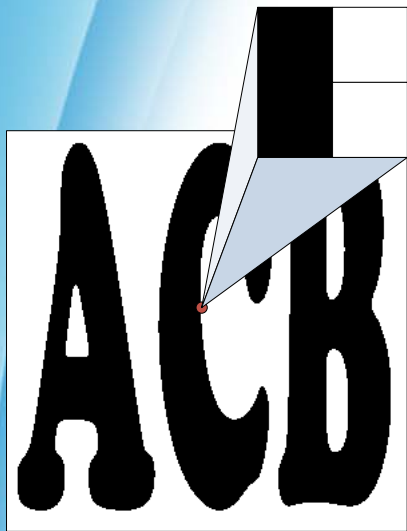

機密影像

$$S_0 \in C_0 \begin{bmatrix} 0 & 1 & 1 & 0 \\ 0 & 1 & 0 & 1 \\ 0 & 0 & 1 & 1 \\ 1 & 0 & 0 & 1 \end{bmatrix}$$

$$S_1 \in C_1 \begin{bmatrix} 0 & 1 & 0 & 1 \\ 0 & 1 & 0 & 1 \\ 0 & 0 & 1 & 1 \end{bmatrix}$$







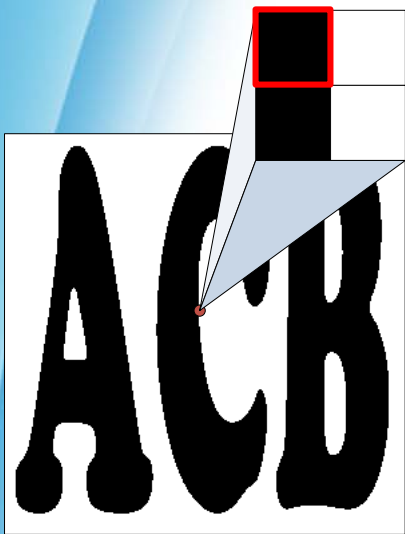

機密影像

$$S_0 \in C_0 \begin{bmatrix} 0 & 1 & 1 & 0 \\ 0 & 1 & 0 & 1 \\ 0 & 0 & 1 & 1 \\ 1 & 0 & 0 & 1 \end{bmatrix}$$

$$S_1 \in C_1 \begin{bmatrix} 0 & 1 & 0 & 1 \\ 0 & 1 & 0 & 1 \\ 0 & 0 & 1 & 1 \end{bmatrix}$$







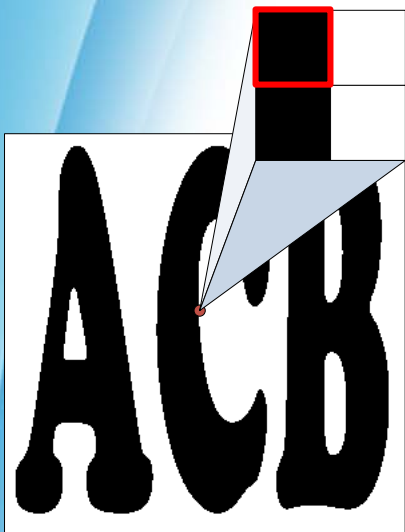

機密影像

$$S_0 \in C_0 \begin{bmatrix} 0 & 1 & 1 & 0 \\ 0 & 1 & 0 & 1 \\ 0 & 0 & 1 & 1 \end{bmatrix}$$

$$S_1 \in C_1 \begin{bmatrix} 1 & 0 & 1 & 0 \\ 1 & 1 & 0 & 0 \\ 1 & 0 & 0 & 1 \end{bmatrix}$$







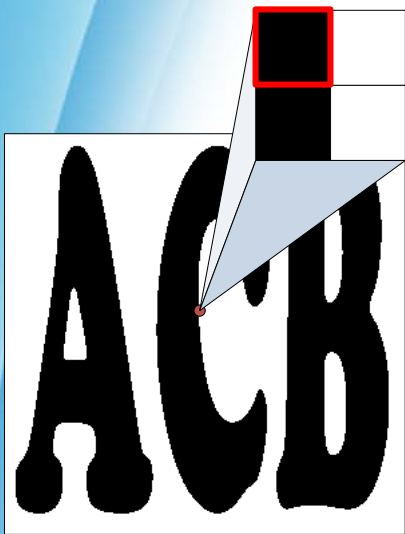

機密影像

$S_0 \in C_0$

0	1	1	0
0	1	0	1
0	0	1	1

$S_1 \in C_1$

1	0	1	0
1	1	0	0
1	0	0	1

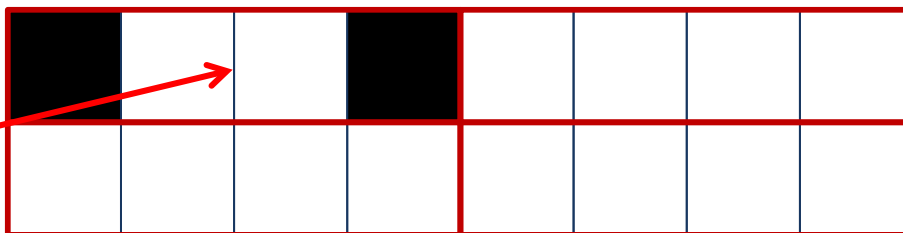
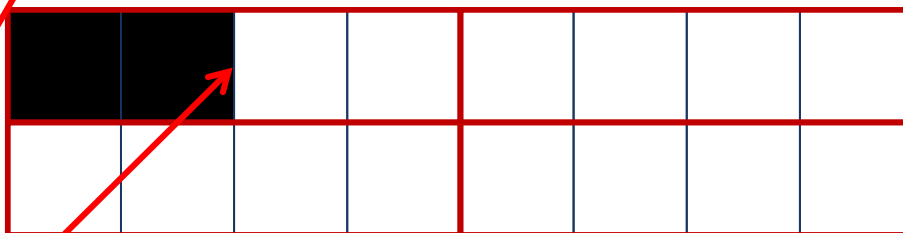
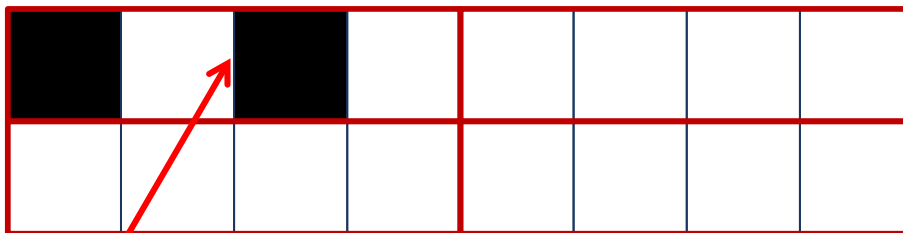

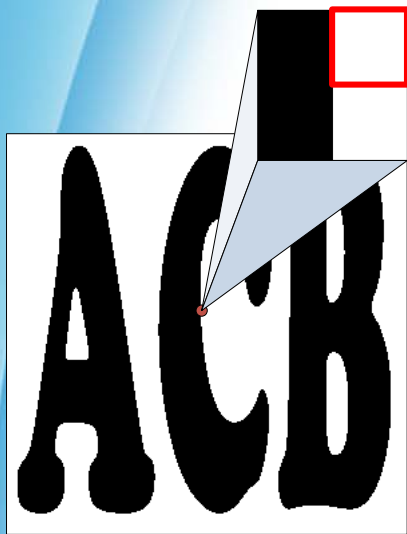

機密影像

$$S_0 \in C_0 \begin{bmatrix} 0 & 1 & 1 & 0 \\ 0 & 1 & 0 & 1 \\ 0 & 0 & 1 & 1 \end{bmatrix}$$

$$S_1 \in C_1 \begin{bmatrix} 1 & 0 & 1 & 0 \\ 1 & 1 & 0 & 0 \\ 1 & 0 & 0 & 1 \end{bmatrix}$$

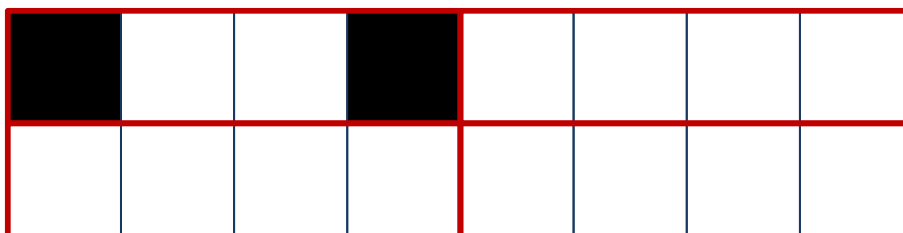

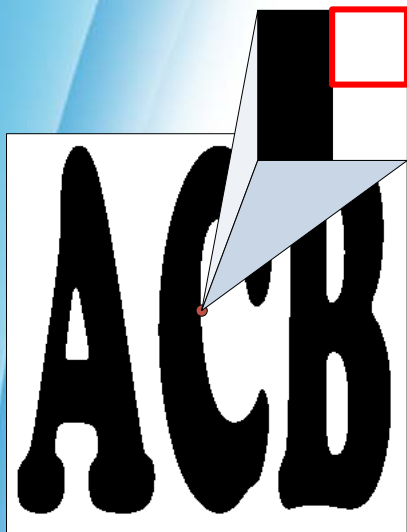

機密影像

$S_0 \in C_0$

1	0	0	1
1	0	1	0
0	0	1	1

$S_1 \in C_1$

1	0	1	0
1	1	0	0
1	0	0	1

■		■					



■	■						



■			■				



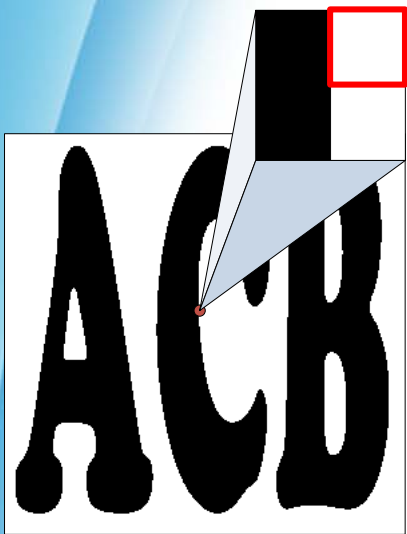

機密影像

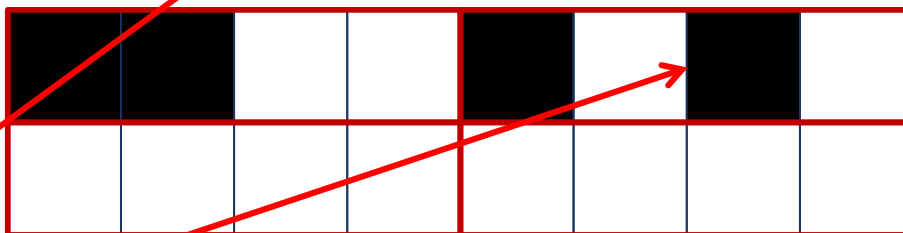
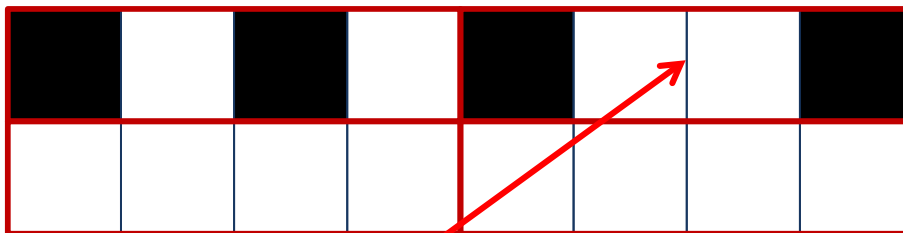

$S_0 \in C_0$

1	0	0	1
1	0	1	0
0	0	1	1

$S_1 \in C_1$

1	0	1	0
1	1	0	0
1	0	0	1

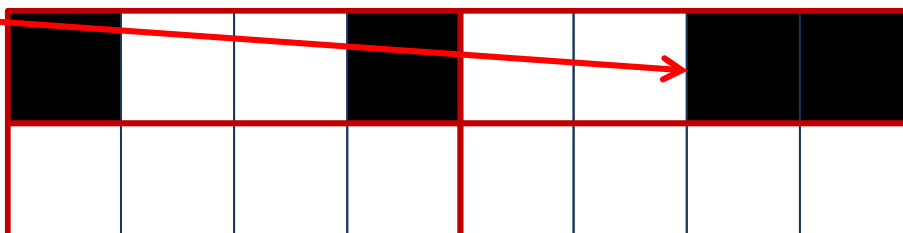

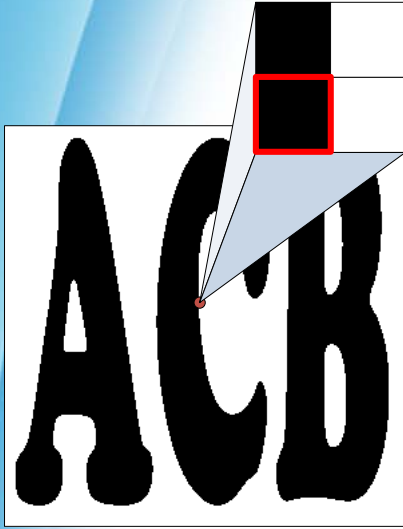

機密影像

$$S_0 \in C_0 \begin{bmatrix} 1 & 0 & 0 & 1 \\ 1 & 0 & 1 & 0 \\ 0 & 0 & 1 & 1 \end{bmatrix}$$

$$S_1 \in C_1 \begin{bmatrix} 1 & 0 & 1 & 0 \\ 1 & 1 & 0 & 0 \\ 1 & 0 & 0 & 1 \end{bmatrix}$$

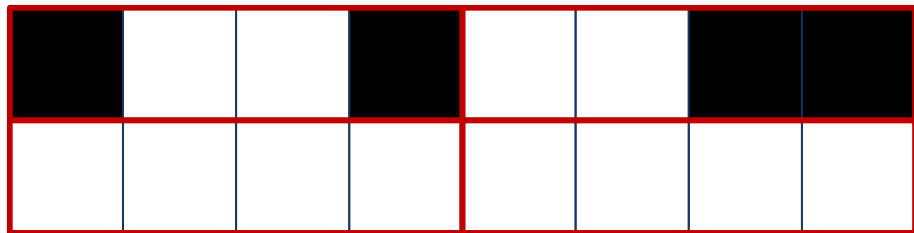
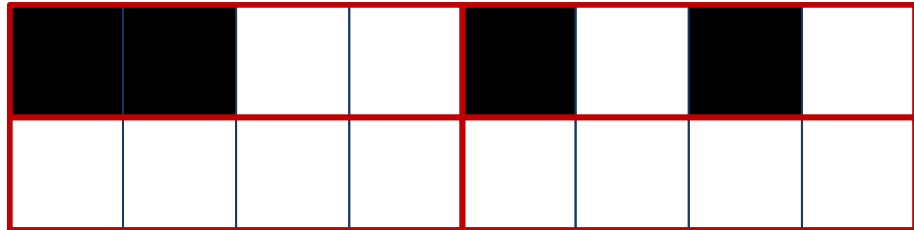
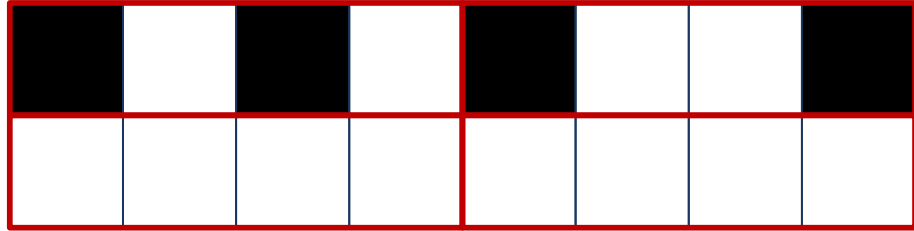

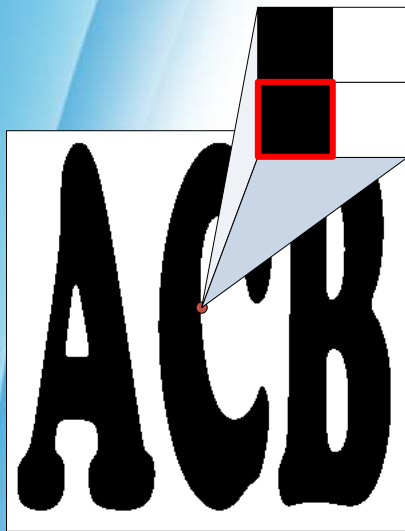

機密影像

$$S_0 \in C_0 \begin{bmatrix} 1 & 0 & 0 & 1 \\ 1 & 0 & 1 & 0 \\ 0 & 0 & 1 & 1 \end{bmatrix}$$

$$S_1 \in C_1 \begin{bmatrix} 0 & 1 & 0 & 1 \\ 1 & 1 & 0 & 0 \\ 0 & 1 & 1 & 0 \end{bmatrix}$$

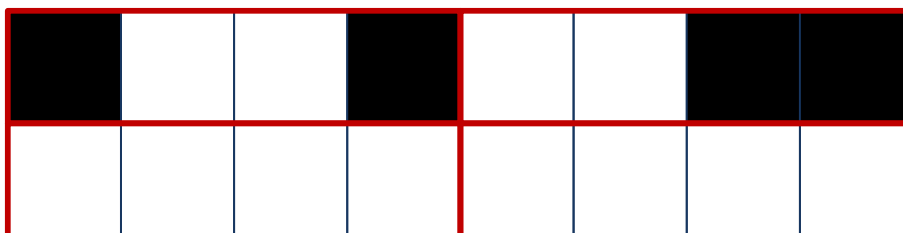

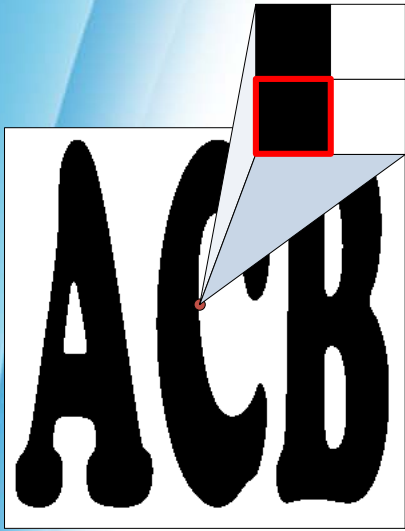

機密影像

$S_0 \in C_0$

$$\begin{bmatrix} 1 & 0 & 0 & 1 \\ 1 & 0 & 1 & 0 \\ 0 & 0 & 1 & 1 \end{bmatrix}$$

$S_1 \in C_1$

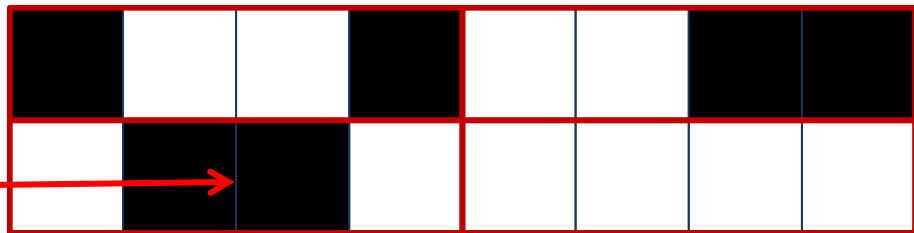
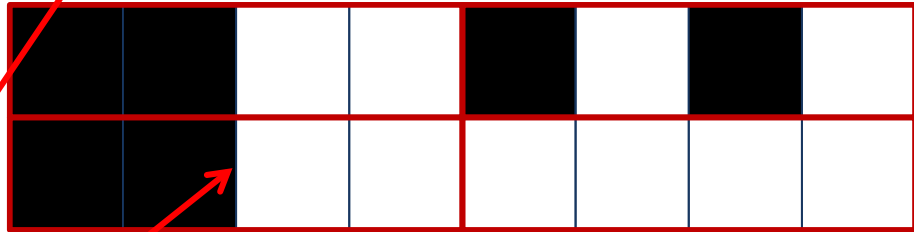
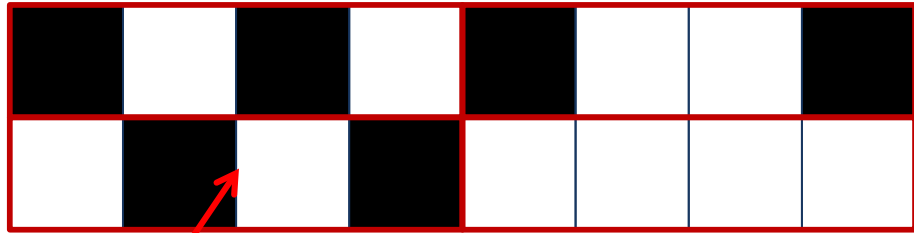
$$\begin{bmatrix} 0 & 1 & 0 & 1 \\ 1 & 1 & 0 & 0 \\ 0 & 1 & 1 & 0 \end{bmatrix}$$

計算機概論



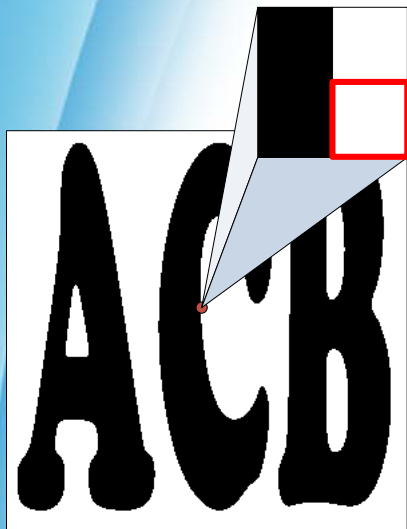

機密影像

$$S_0 \in C_0 \begin{bmatrix} 1 & 0 & 0 & 1 \\ 1 & 0 & 1 & 0 \\ 0 & 0 & 1 & 1 \\ 0 & 1 & 0 & 1 \end{bmatrix}$$

$$S_1 \in C_1 \begin{bmatrix} 1 & 1 & 0 & 0 \\ 1 & 1 & 0 & 0 \\ 0 & 1 & 1 & 0 \end{bmatrix}$$

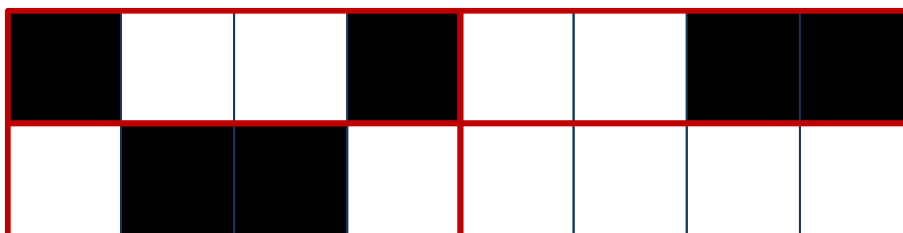
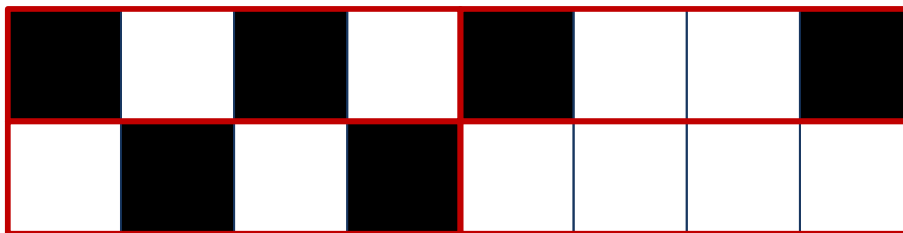



機密影像

$S_0 \in C_0$

0	1	0	1
1	0	0	1
1	1	0	0

$S_1 \in C_1$

0	1	0	1
1	1	0	0
0	1	1	0

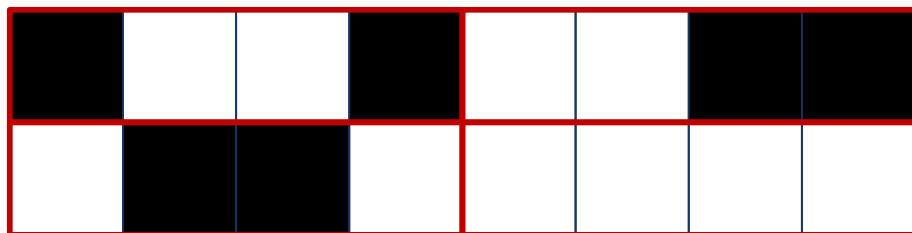
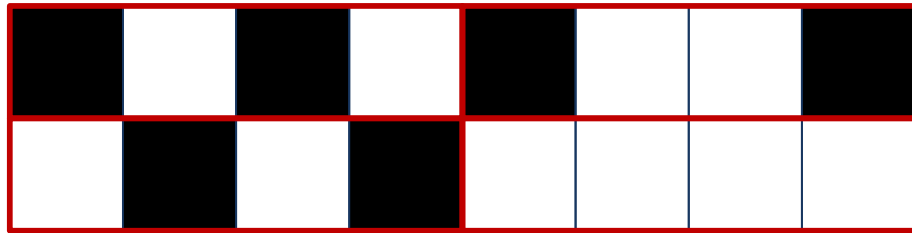

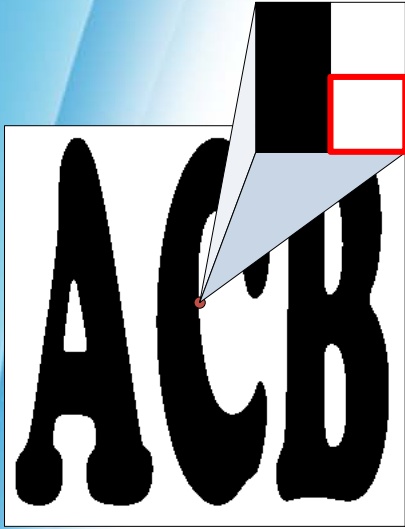

機密影像

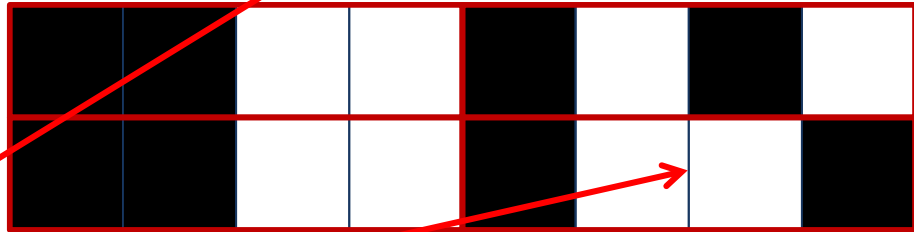
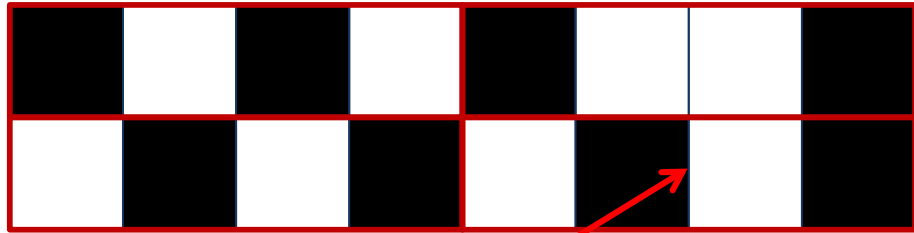

$S_0 \in C_0$

0	1	0	1
1	0	0	1
1	1	0	0

$S_1 \in C_1$

0	1	0	1
1	1	0	0
0	1	1	0

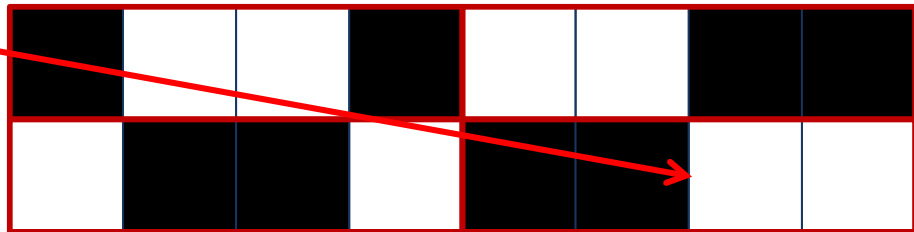



機密影像

$$S_0 \in C_0 \begin{bmatrix} 0 & 1 & 0 & 1 \\ 1 & 0 & 0 & 1 \\ 1 & 1 & 0 & 0 \end{bmatrix}$$

$$S_1 \in C_1 \begin{bmatrix} 0 & 1 & 0 & 1 \\ 1 & 1 & 0 & 0 \\ 0 & 1 & 1 & 0 \end{bmatrix}$$

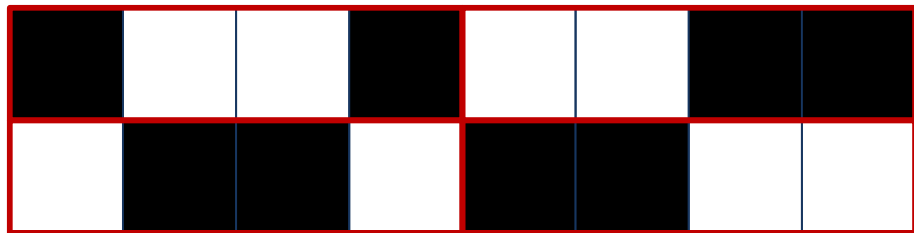
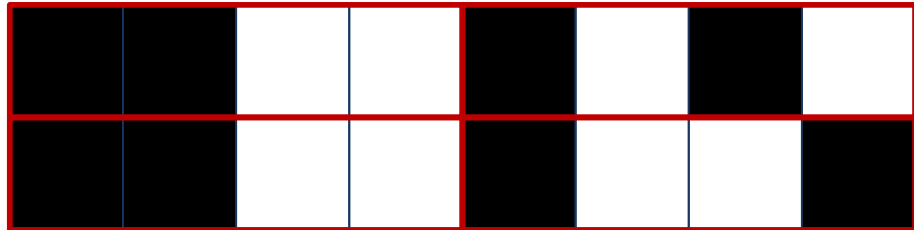
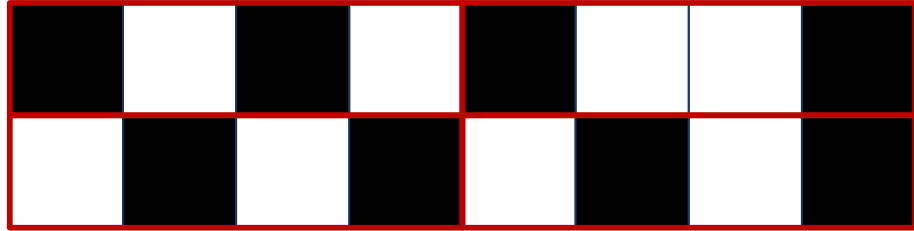



機密影像

$$S_0 \in C_0 \begin{bmatrix} 0 & 1 & 0 & 1 \\ 1 & 0 & 0 & 1 \\ 1 & 1 & 0 & 0 \end{bmatrix}$$

$$S_1 \in C_1 \begin{bmatrix} 0 & 1 & 0 & 1 \\ 1 & 1 & 0 & 0 \\ 0 & 1 & 1 & 0 \end{bmatrix}$$

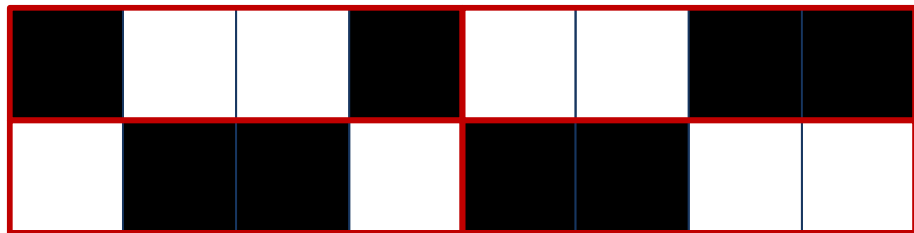
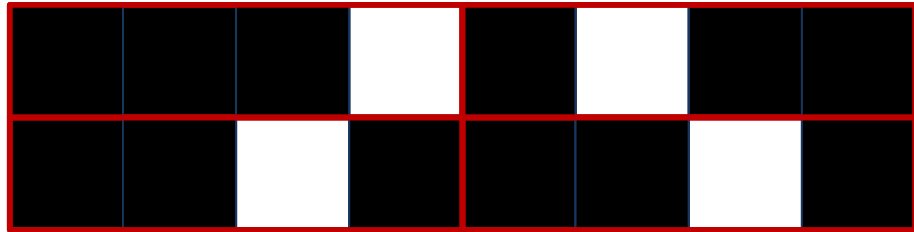



機密影像

$$S_0 \in C_0 \begin{bmatrix} 0 & 1 & 0 & 1 \\ 1 & 0 & 0 & 1 \\ 1 & 1 & 0 & 0 \end{bmatrix}$$

$$S_1 \in C_1 \begin{bmatrix} 0 & 1 & 0 & 1 \\ 1 & 1 & 0 & 0 \\ 0 & 1 & 1 & 0 \end{bmatrix}$$

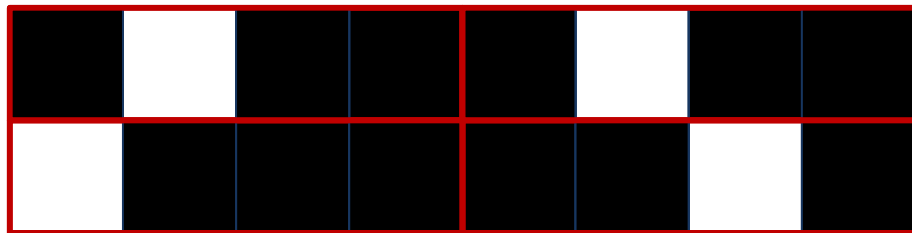
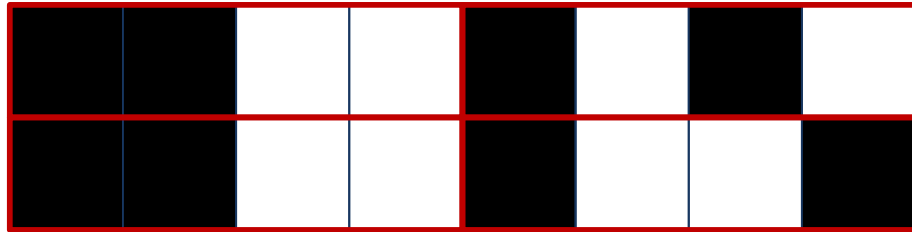



機密影像

$$S_0 \in C_0 \begin{bmatrix} 0 & 1 & 0 & 1 \\ 1 & 0 & 0 & 1 \\ 1 & 1 & 0 & 0 \end{bmatrix}$$

$$S_1 \in C_1 \begin{bmatrix} 0 & 1 & 0 & 1 \\ 1 & 1 & 0 & 0 \\ 0 & 1 & 1 & 0 \end{bmatrix}$$

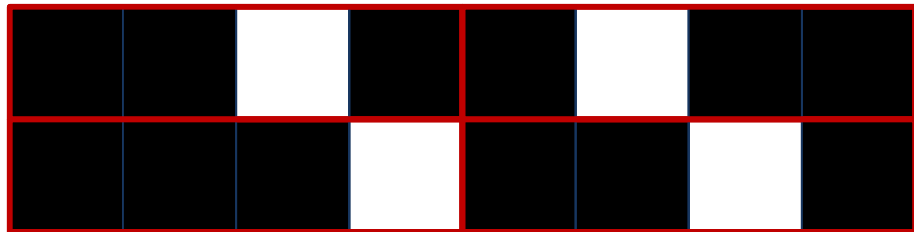
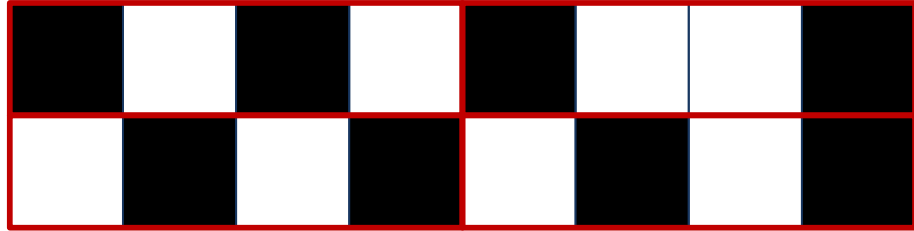



機密影像

$$S_0 \in C_0 \begin{bmatrix} 0 & 1 & 0 & 1 \\ 1 & 0 & 0 & 1 \\ 1 & 1 & 0 & 0 \end{bmatrix}$$

$$S_1 \in C_1 \begin{bmatrix} 0 & 1 & 0 & 1 \\ 1 & 1 & 0 & 0 \\ 0 & 1 & 1 & 0 \end{bmatrix}$$

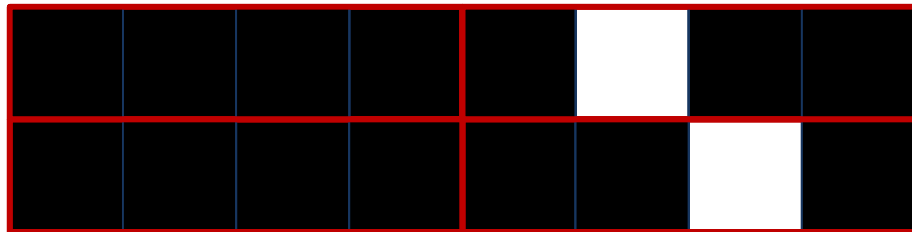

旋轉式視覺密碼

(Wu and Chen, 1998)

p_1	□	□	■	■	□	□	■	■	□	□	■	■	□	□	■	■
p_2	□	■	□	■	□	■	□	■	□	■	□	■	□	■	□	■
s_1	■	■	■	■	■	■	■	■	■	■	■	■	■	■	■	■
s_2	■	■	■	■	■	■	■	■	■	■	■	■	■	■	■	■

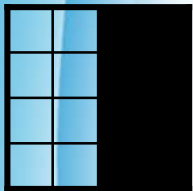

P_1

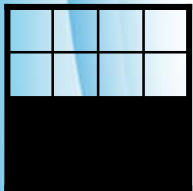
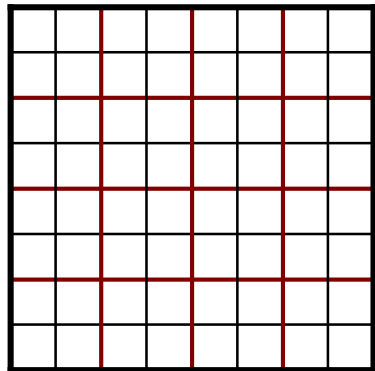

P_2

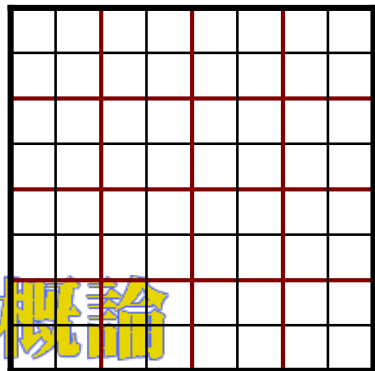

旋轉式視覺密碼

(Wu and Chen, 1998)

p_1	□	□	■	■	□	□	■	■	□	□	■	■	□	□	■	■
p_2	□	■	□	■	□	■	□	■	□	■	□	■	□	■	□	■
s_1	■	■	■	■	■	■	■	■	■	■	■	■	■	■	■	■
s_2	■	■	■	■	■	■	■	■	■	■	■	■	■	■	■	■

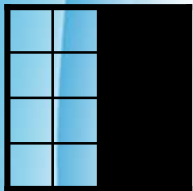

P_1

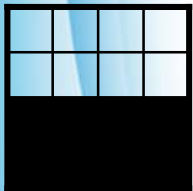
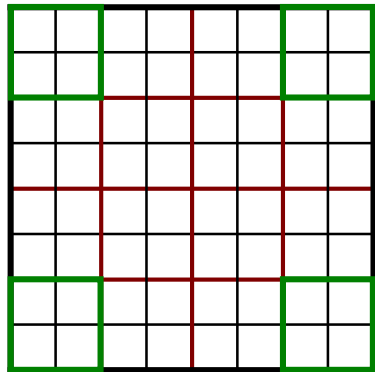

P_2

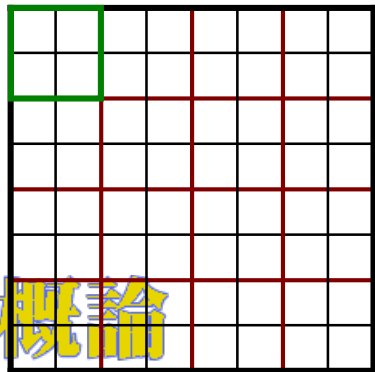

旋轉式視覺密碼

(Wu and Chen, 1998)

p_1	□	□	■	■	□	□	■	■	□	□	■	■	□	□	■	■
p_2	□	■	□	■	□	■	□	■	□	■	□	■	□	■	□	■
s_1	■	■	■	■	■	■	■	■	■	■	■	■	■	■	■	■
s_2	■	■	■	■	■	■	■	■	■	■	■	■	■	■	■	■

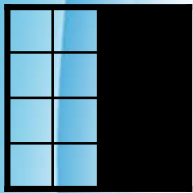

P_1

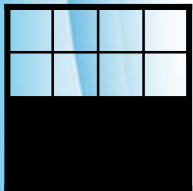
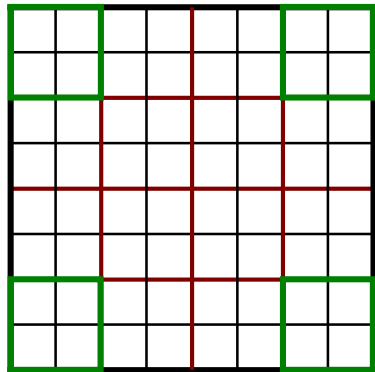

P_2

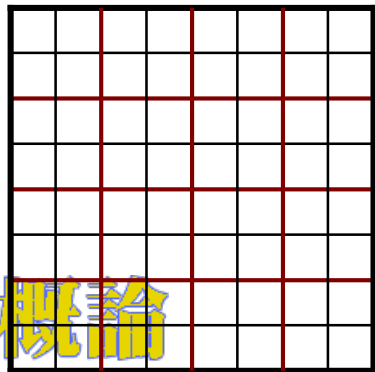

旋轉式視覺密碼

(Wu and Chen, 1998)

p_1	□	□	■	■	□	□	■	■	□	□	■	■	□	□	■	■
p_2	□	■	□	■	□	■	□	■	□	■	□	■	□	■	□	■
s_1	■	■	■	■	■	■	■	■	■	■	■	■	■	■	■	■
s_2	■	■	■	■	■	■	■	■	■	■	■	■	■	■	■	■

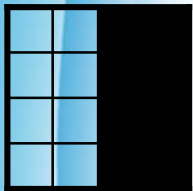

P_1

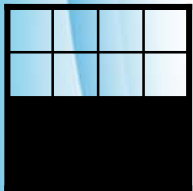
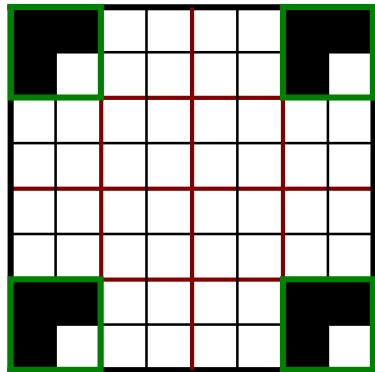

P_2

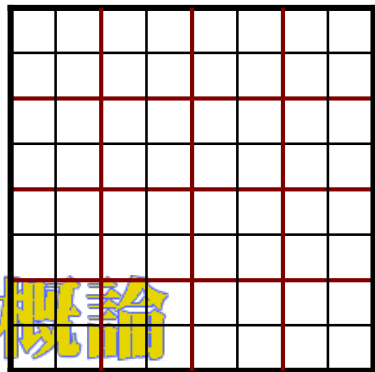

旋轉式視覺密碼

(Wu and Chen, 1998)

p_1	□	□	■	■	□	□	■	■	□	□	■	■	□	□	■	■
p_2	□	■	□	■	□	■	□	■	□	■	□	■	□	■	□	■
s_1	■	■	■	■	■	■	■	■	■	■	■	■	■	■	■	■
s_2	■	■	■	■	■	■	■	■	■	■	■	■	■	■	■	■

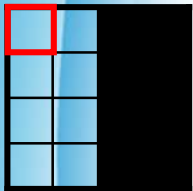

P_1

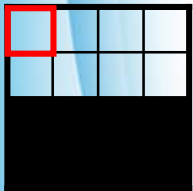
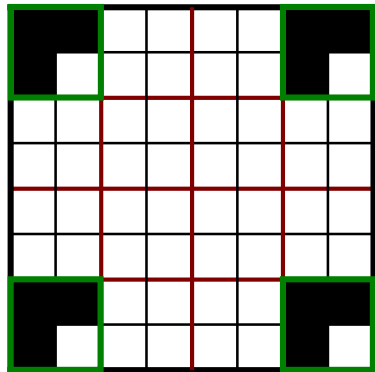

P_2

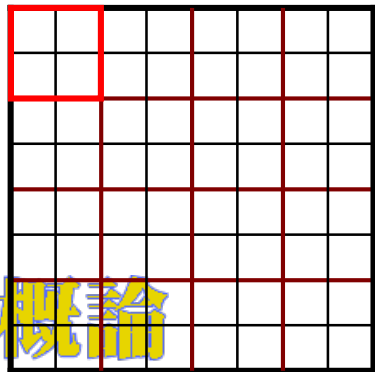

旋轉式視覺密碼

(Wu and Chen, 1998)

p_1	□	□	■	■	□	□	■	■	□	□	■	■	□	□	■	■
p_2	□	■	□	■	□	■	□	■	□	■	□	■	□	■	□	■
s_1	■	■	■	■	■	■	■	■	■	■	■	■	■	■	■	■
s_2	■	■	■	■	■	■	■	■	■	■	■	■	■	■	■	■

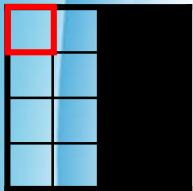

P_1

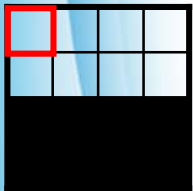
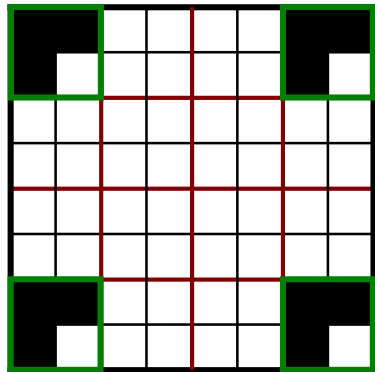

P_2

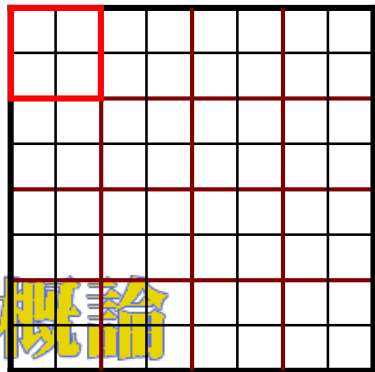

旋轉式視覺密碼

(Wu and Chen, 1998)

p_1	□	□	■	■	□	□	■	■	□	□	■	■	□	□	■	■
p_2	□	■	□	■	□	■	□	■	□	■	□	■	□	■	□	■
s_1	■	■	■	■	■	■	■	■	■	■	■	■	■	■	■	■
s_2	■	■	■	■	■	■	■	■	■	■	■	■	■	■	■	■

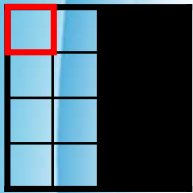

P_1

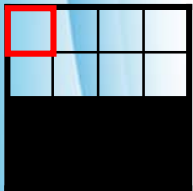
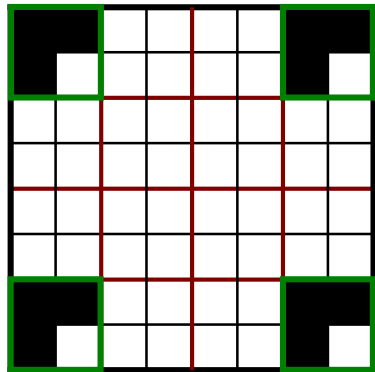

P_2

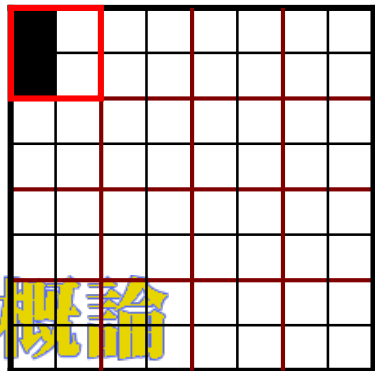

旋轉式視覺密碼

(Wu and Chen, 1998)

p_1	□	□	■	■	□	□	■	■	□	□	■	■	□	□	■	■
p_2	□	■	□	■	□	■	□	■	□	■	□	■	□	■	□	■
s_1	■	■	■	■	■	■	■	■	■	■	■	■	■	■	■	■
s_2	■	■	■	■	■	■	■	■	■	■	■	■	■	■	■	■

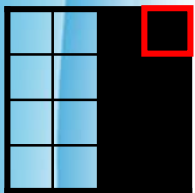

P_1

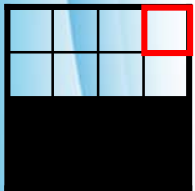
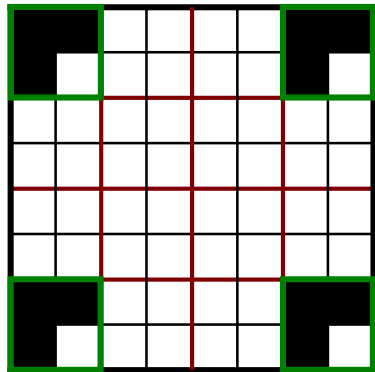

P_2

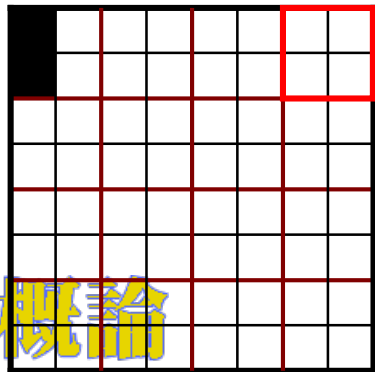

旋轉式視覺密碼

(Wu and Chen, 1998)

p_1	□	□	■	■	□	□	■	■	□	□	■	■	□	□	■	■
p_2	□	■	□	■	□	■	□	■	□	■	□	■	□	■	□	■
s_1	■	■	■	■	■	■	■	■	■	■	■	■	■	■	■	■
s_2	■	■	■	■	■	■	■	■	■	■	■	■	■	■	■	■

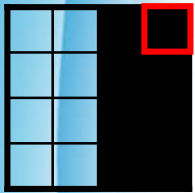

P_1

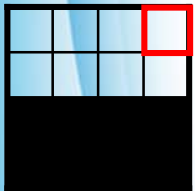
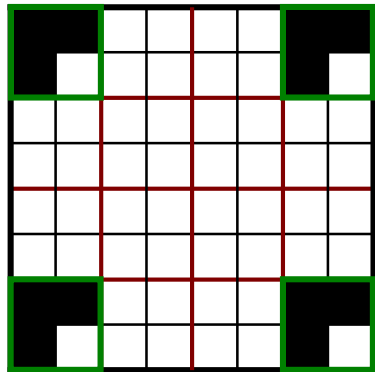

P_2

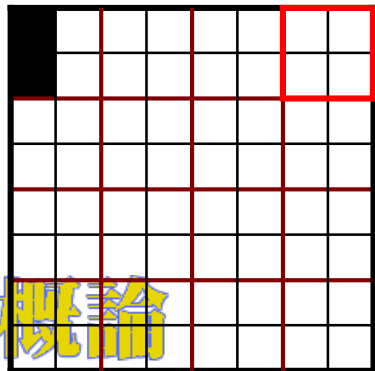

旋轉式視覺密碼

(Wu and Chen, 1998)

p_1	□	□	■	■	□	□	■	■	□	□	■	■	□	□	■	■
p_2	□	■	□	■	□	■	□	■	□	■	□	■	□	■	□	■
s_1	■	■	■	■	■	■	■	■	■	■	■	■	■	■	■	■
s_2	■	■	■	■	■	■	■	■	■	■	■	■	■	■	■	■

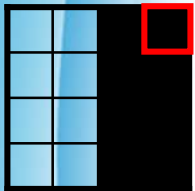

P_1

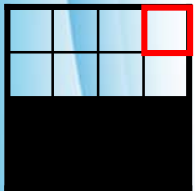
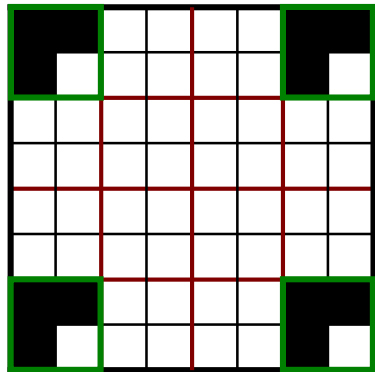

P_2

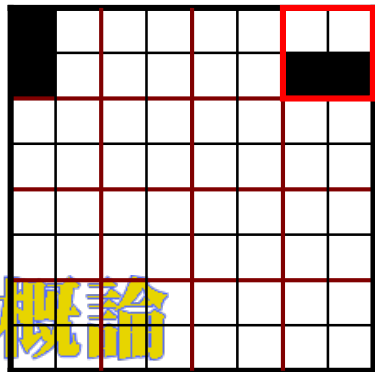

旋轉式視覺密碼

(Wu and Chen, 1998)

p_1	□	□	■	■	□	□	■	■	□	□	■	■	□	□	■	■
p_2	□	■	□	■	□	■	□	■	□	■	□	■	□	■	□	■
s_1	■	■	■	■	■	■	■	■	■	■	■	■	■	■	■	■
s_2	■	■	■	■	■	■	■	■	■	■	■	■	■	■	■	■

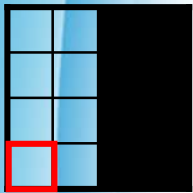

P_1

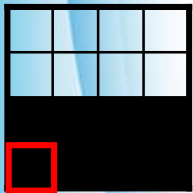
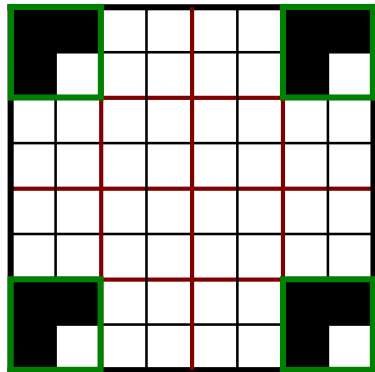

P_2

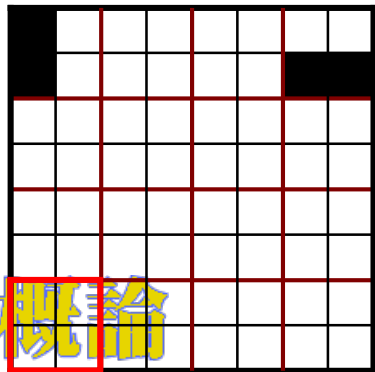

旋轉式視覺密碼

(Wu and Chen, 1998)

p_1	□	□	■	■	□	□	■	■	□	□	■	■	□	□	■	■
p_2	□	■	□	■	□	■	□	■	□	■	□	■	□	■	□	■
s_1	■	■	■	■	■	■	■	■	■	■	■	■	■	■	■	■
s_2	■	■	■	■	■	■	■	■	■	■	■	■	■	■	■	■

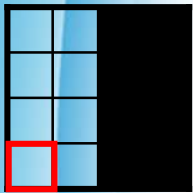

P_1

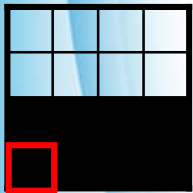
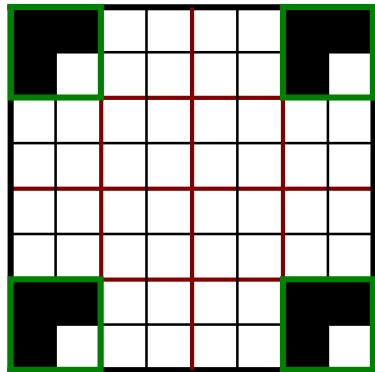

P_2

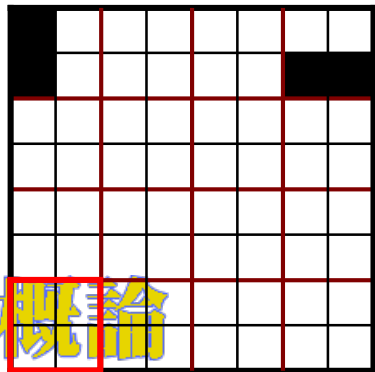

計算機概論



旋轉式視覺密碼

(Wu and Chen, 1998)

p_1	□	□	■	■	□	□	■	■	□	□	■	■	□	□	■	■
p_2	□	■	□	■	□	■	□	■	□	■	□	■	□	■	□	■
s_1	■	■	■	■	■	■	■	■	■	■	■	■	■	■	■	■
s_2	■	■	■	■	■	■	■	■	■	■	■	■	■	■	■	■

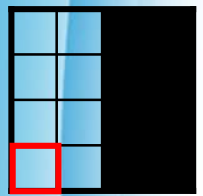

P_1

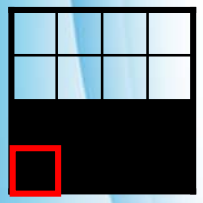
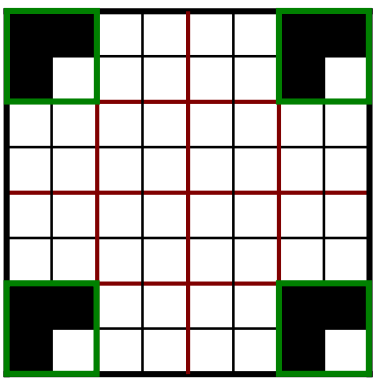

P_2

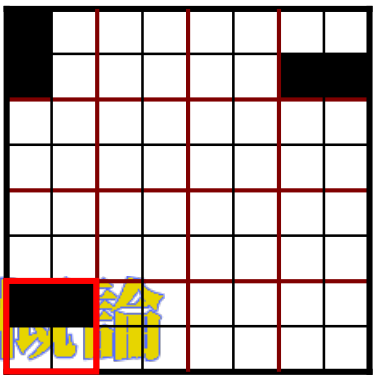

旋轉式視覺密碼

(Wu and Chen, 1998)

p_1	□	□	■	■	□	□	■	■	□	□	■	■	□	□	■	■
p_2	□	■	□	■	□	■	□	■	□	■	□	■	□	■	□	■
s_1	■	■	■	■	■	■	■	■	■	■	■	■	■	■	■	■
s_2	■	■	■	■	■	■	■	■	■	■	■	■	■	■	■	■

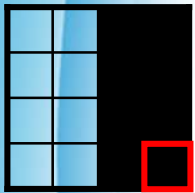

P_1

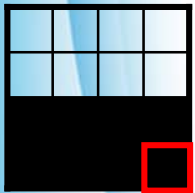
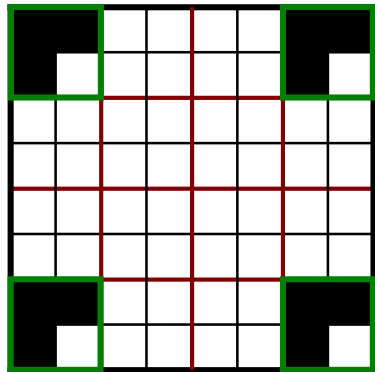

P_2

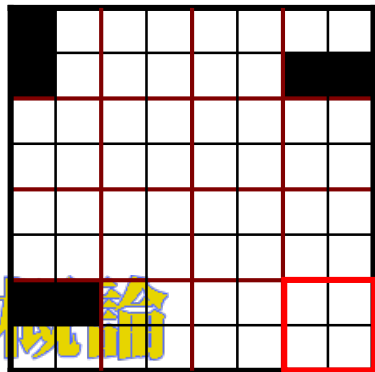

旋轉式視覺密碼

(Wu and Chen, 1998)

p_1	□	□	■	■	□	□	■	■	□	□	■	■	□	□	■	■
p_2	□	■	□	■	□	■	□	■	□	■	□	■	□	■	□	■
s_1	■	■	■	■	■	■	■	■	■	■	■	■	■	■	■	■
s_2	■	■	■	■	■	■	■	■	■	■	■	■	■	■	■	■

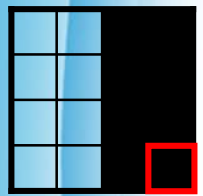

P_1

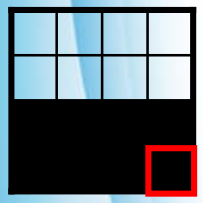
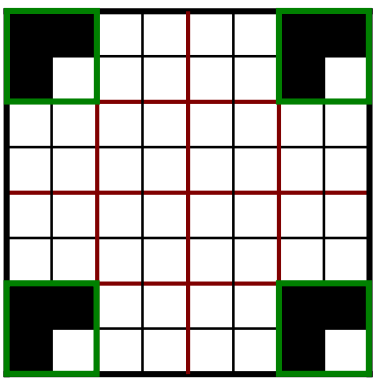

P_2

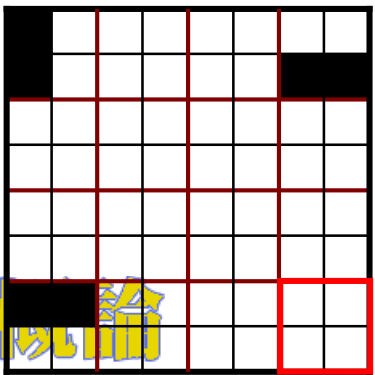

旋轉式視覺密碼

(Wu and Chen, 1998)

p_1	□	□	■	■	□	□	■	■	□	□	■	■	□	□	■	■
p_2	□	■	□	■	□	■	□	■	□	■	□	■	□	■	□	■
s_1	■	■	■	■	■	■	■	■	■	■	■	■	■	■	■	■
s_2	■	■	■	■	■	■	■	■	■	■	■	■	■	■	■	■

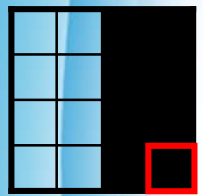

P_1

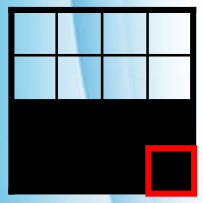
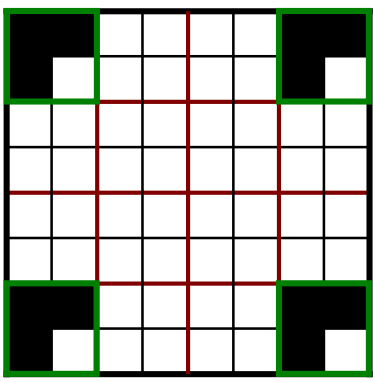

P_2

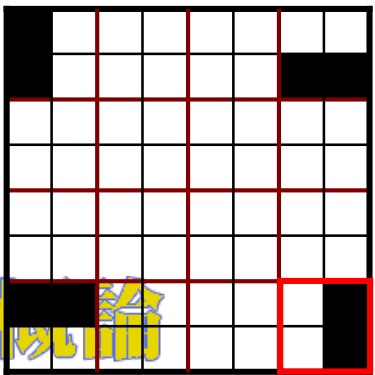

旋轉式視覺密碼

(Wu and Chen, 1998)

p_1	□	□	■	■	□	□	■	■	□	□	■	■	□	□	■	■
p_2	□	■	□	■	□	■	□	■	□	■	□	■	□	■	□	■
s_1	■	■	■	■	■	■	■	■	■	■	■	■	■	■	■	■
s_2	■	■	■	■	■	■	■	■	■	■	■	■	■	■	■	■

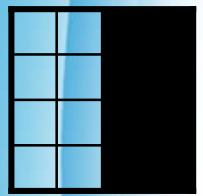

P_1

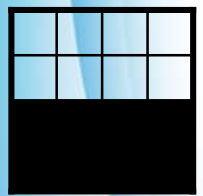
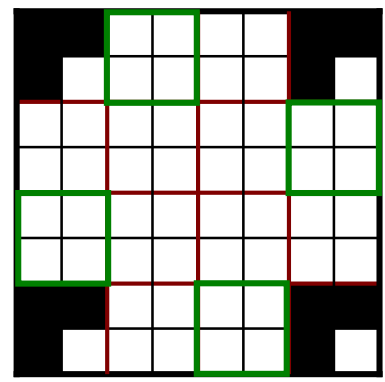

P_2

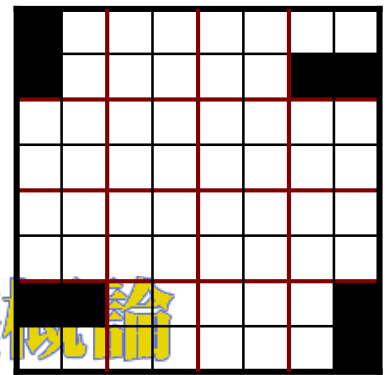

旋轉式視覺密碼

(Wu and Chen, 1998)

p_1	□	□	■	■	□	□	■	■	□	□	■	■	□	□	■	■
p_2	□	■	□	■	□	■	□	■	□	■	□	■	□	■	□	■
s_1	■	■	■	■	■	■	■	■	■	■	■	■	■	■	■	■
s_2	■	■	■	■	■	■	■	■	■	■	■	■	■	■	■	■

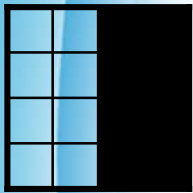

P_1

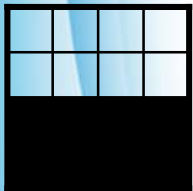
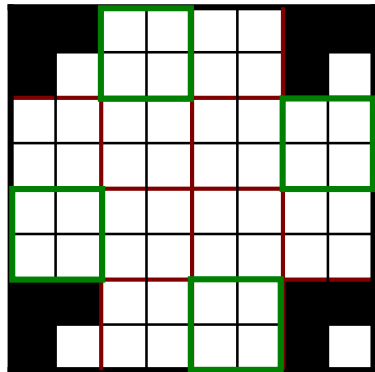

P_2

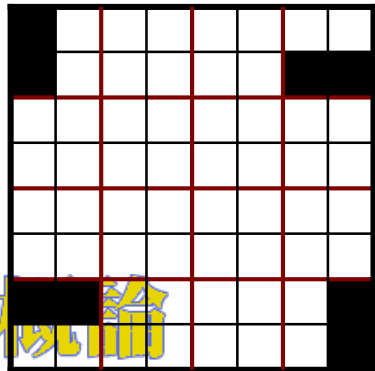

旋轉式視覺密碼

(Wu and Chen, 1998)

p_1	□	□	■	■	□	□	■	■	□	□	■	■	□	□	■	■
p_2	□	■	□	■	□	■	□	■	□	■	□	■	□	■	□	■
s_1	■	■	■	■	■	■	■	■	■	■	■	■	■	■	■	■
s_2	■	■	■	■	■	■	■	■	■	■	■	■	■	■	■	■

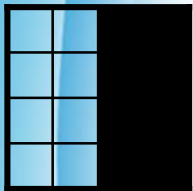

P_1

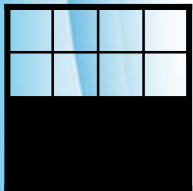
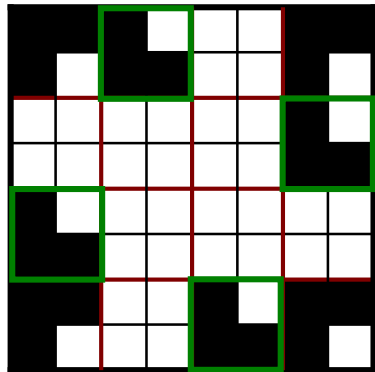

P_2

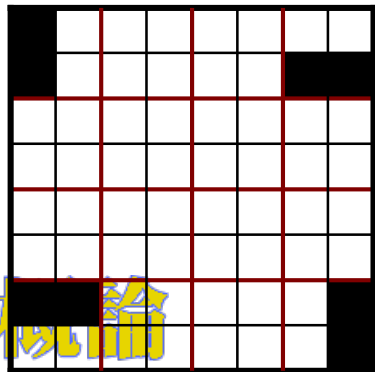

旋轉式視覺密碼

(Wu and Chen, 1998)

p_1	□	□	■	■	□	□	■	■	□	□	■	■	□	□	■	■
p_2	□	■	□	■	□	■	□	■	□	■	□	■	□	■	□	■
s_1	■	■	■	■	■	■	■	■	■	■	■	■	■	■	■	■
s_2	■	■	■	■	■	■	■	■	■	■	■	■	■	■	■	■

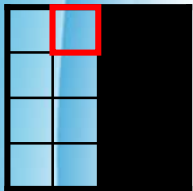

P_1

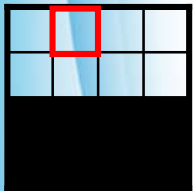
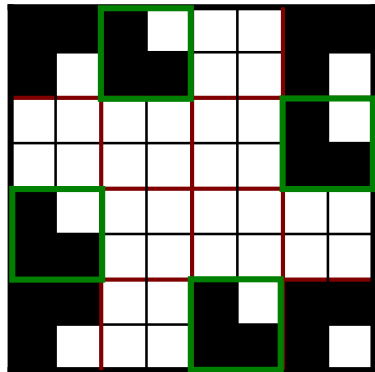

P_2

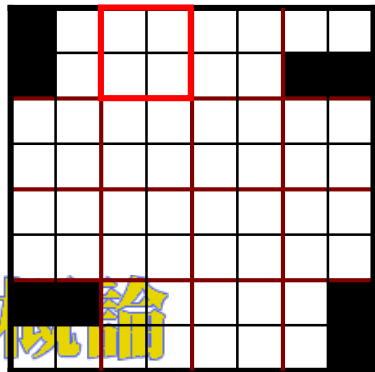

旋轉式視覺密碼

(Wu and Chen, 1998)

p_1	□	□	■	■	□	□	■	■	□	□	■	■	□	□	■	■
p_2	□	■	□	■	□	■	□	■	□	■	□	■	□	■	□	■
s_1	■	■	■	■	■	■	■	■	■	■	■	■	■	■	■	■
s_2	■	■	■	■	■	■	■	■	■	■	■	■	■	■	■	■

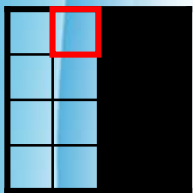

P_1

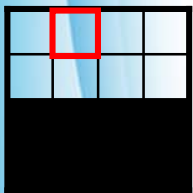
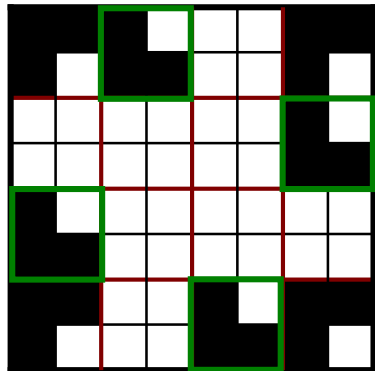

P_2

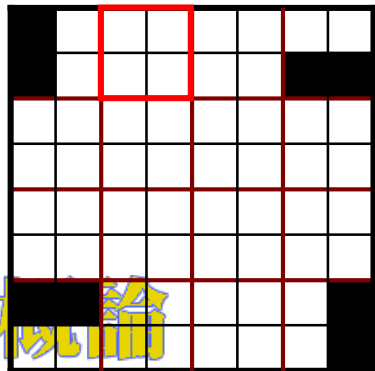

旋轉式視覺密碼

(Wu and Chen, 1998)

p_1	□	□	■	■	□	□	■	■	□	□	■	■	□	□	■	■
p_2	□	■	□	■	□	■	□	■	□	■	□	■	□	■	□	■
s_1	■	■	■	■	■	■	■	■	■	■	■	■	■	■	■	■
s_2	■	■	■	■	■	■	■	■	■	■	■	■	■	■	■	■

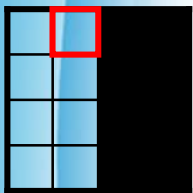

P_1

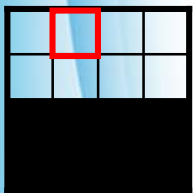
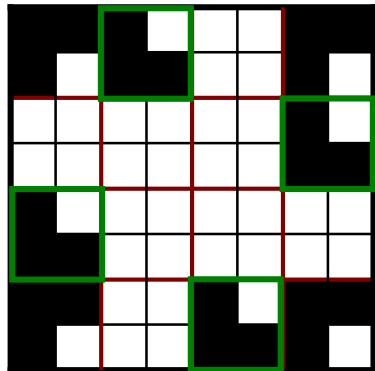

P_2

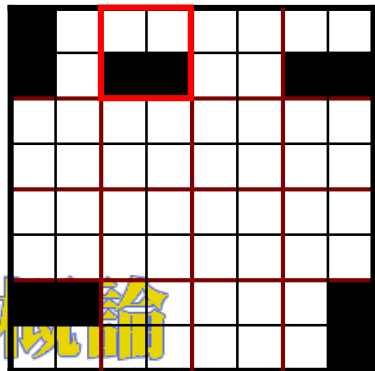

旋轉式視覺密碼

(Wu and Chen, 1998)

p_1	□	□	■	■	□	□	■	■	□	□	■	■	□	□	■	■
p_2	□	■	□	■	□	■	□	■	□	■	□	■	□	■	□	■
s_1	■	■	■	■	■	■	■	■	■	■	■	■	■	■	■	■
s_2	■	■	■	■	■	■	■	■	■	■	■	■	■	■	■	■

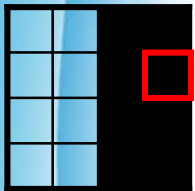

P_1

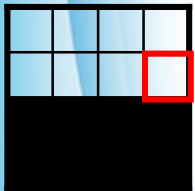
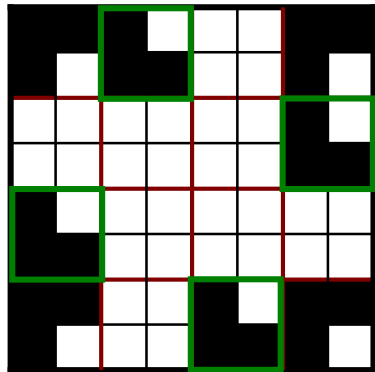

P_2

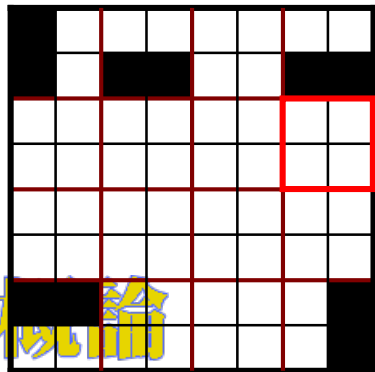

旋轉式視覺密碼

(Wu and Chen, 1998)

p_1	□	□	■	■	□	□	■	■	□	□	■	■	□	□	■	■
p_2	□	■	□	■	□	■	□	■	□	■	□	■	□	■	□	■
s_1	■	■	■	■	■	■	■	■	■	■	■	■	■	■	■	■
s_2	■	■	■	■	■	■	■	■	■	■	■	■	■	■	■	■

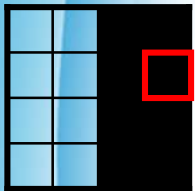

P_1

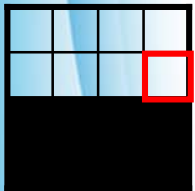
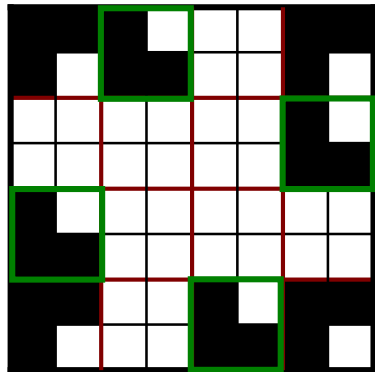

P_2

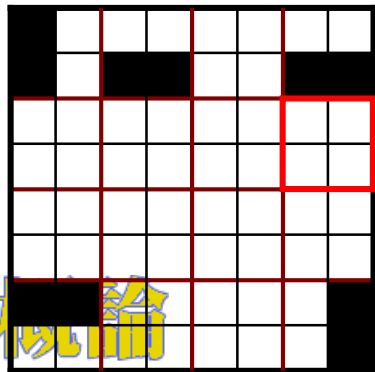

旋轉式視覺密碼

(Wu and Chen, 1998)

p_1	□	□	■	■	□	□	■	■	□	□	■	■	□	□	■	■
p_2	□	■	□	■	□	■	□	■	□	■	□	■	□	■	□	■
s_1	■	■	■	■	■	■	■	■	■	■	■	■	■	■	■	■
s_2	■	■	■	■	■	■	■	■	■	■	■	■	■	■	■	■

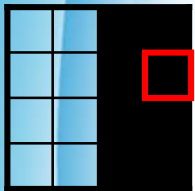

P_1

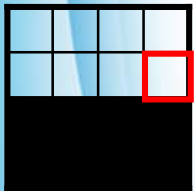
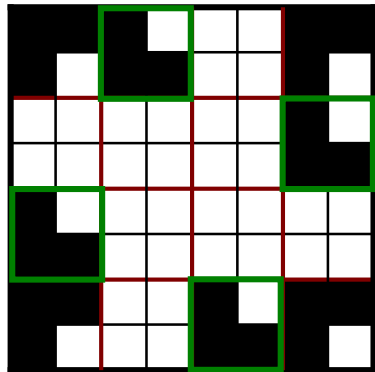

P_2

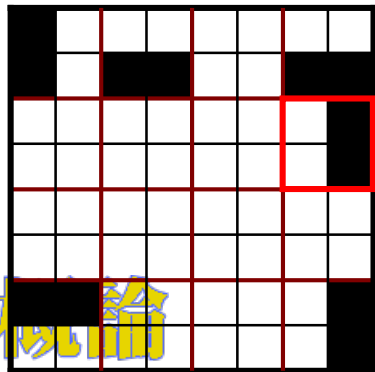

旋轉式視覺密碼

(Wu and Chen, 1998)

p_1	□	□	■	■	□	□	■	■	□	□	■	■	□	□	■	■
p_2	□	■	□	■	□	■	□	■	□	■	□	■	□	■	□	■
s_1	■	■	■	■	■	■	■	■	■	■	■	■	■	■	■	■
s_2	■	■	■	■	■	■	■	■	■	■	■	■	■	■	■	■

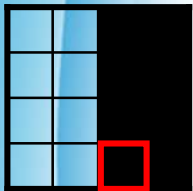

P_1

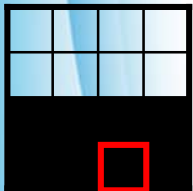
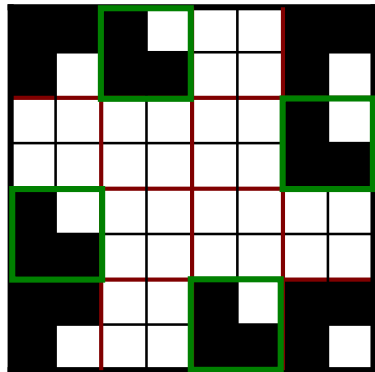

P_2

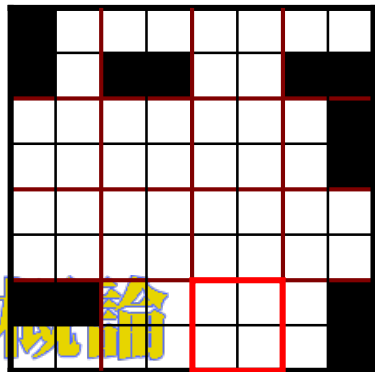

旋轉式視覺密碼

(Wu and Chen, 1998)

p_1	□	□	■	■	□	□	■	■	□	□	■	■	□	□	■	■
p_2	□	■	□	■	□	■	□	■	□	■	□	■	□	■	□	■
s_1	■	■	■	■	■	■	■	■	■	■	■	■	■	■	■	■
s_2	■	■	■	■	■	■	■	■	■	■	■	■	■	■	■	■

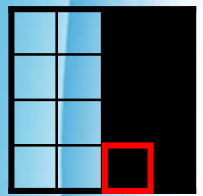

P_1

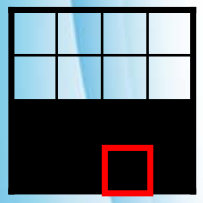
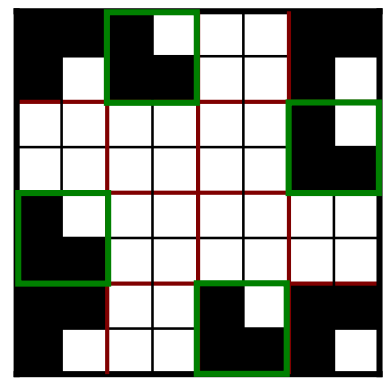

P_2

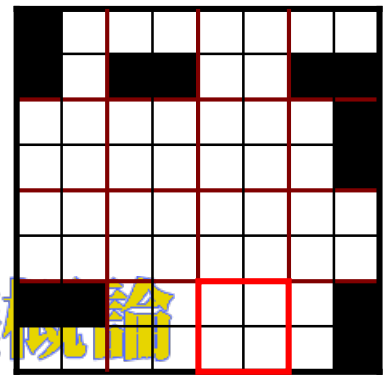

旋轉式視覺密碼

(Wu and Chen, 1998)

p_1	□	□	■	■	□	□	■	■	□	□	■	■	□	□	■	■
p_2	□	■	□	■	□	■	□	■	□	■	□	■	□	■	□	■
s_1	■	■	■	■	■	■	■	■	■	■	■	■	■	■	■	■
s_2	■	■	■	■	■	■	■	■	■	■	■	■	■	■	■	■

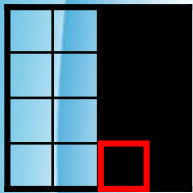

P_1

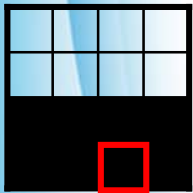
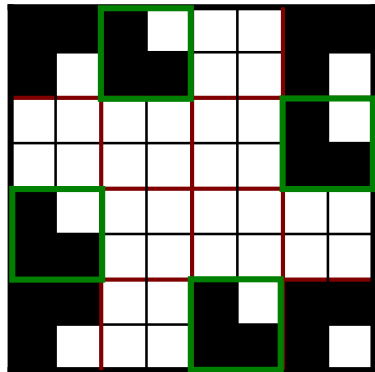

P_2

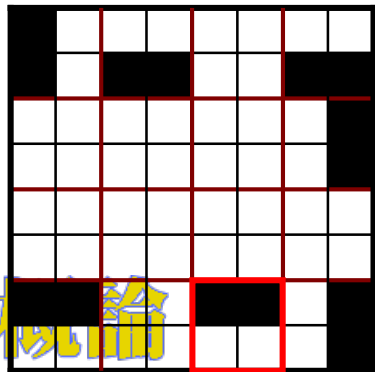

旋轉式視覺密碼

(Wu and Chen, 1998)

p_1	□	□	■	■	□	□	■	■	□	□	■	■	□	□	■	■
p_2	□	■	□	■	□	■	□	■	□	■	□	■	□	■	□	■
s_1	■	■	■	■	■	■	■	■	■	■	■	■	■	■	■	■
s_2	■	■	■	■	■	■	■	■	■	■	■	■	■	■	■	■

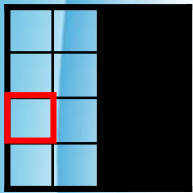

P_1

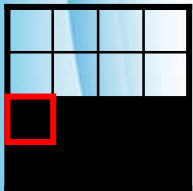
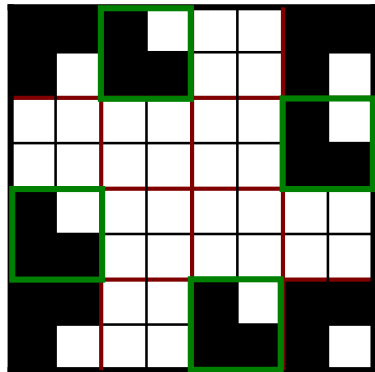

P_2

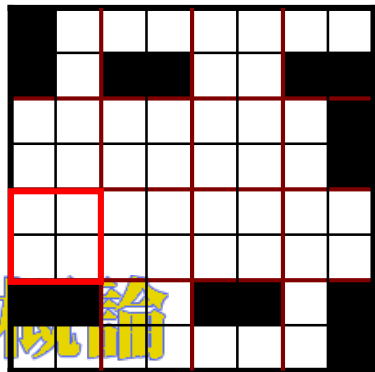

旋轉式視覺密碼

(Wu and Chen, 1998)

p_1	□	□	■	■	□	□	■	■	□	□	■	■	□	□	■	■
p_2	□	■	□	■	□	■	□	■	□	■	□	■	□	■	□	■
s_1	■	■	■	■	■	■	■	■	■	■	■	■	■	■	■	■
s_2	■	■	■	■	■	■	■	■	■	■	■	■	■	■	■	■

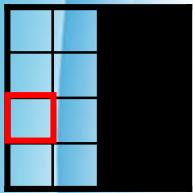

P_1

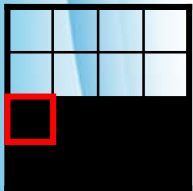
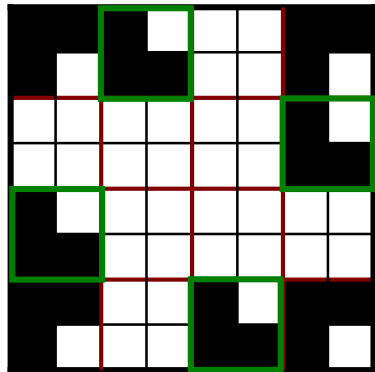

P_2

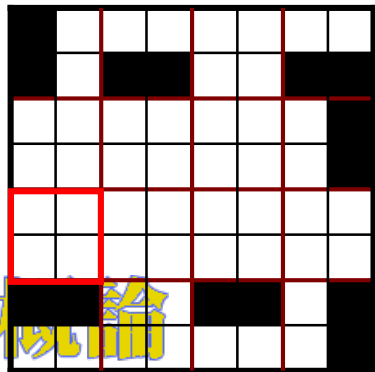

旋轉式視覺密碼

(Wu and Chen, 1998)

p_1	□	□	■	■	□	□	■	■	□	□	■	■	□	□	■	■
p_2	□	■	□	■	□	■	□	■	□	■	□	■	□	■	□	■
s_1	■	■	■	■	■	■	■	■	■	■	■	■	■	■	■	■
s_2	■	■	■	■	■	■	■	■	■	■	■	■	■	■	■	■

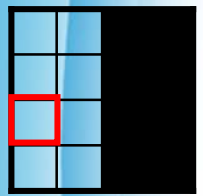

P_1

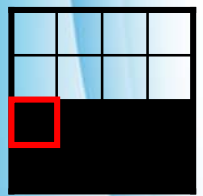
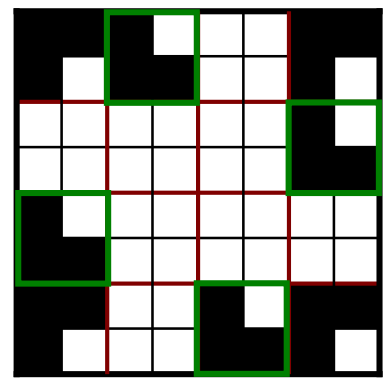

P_2

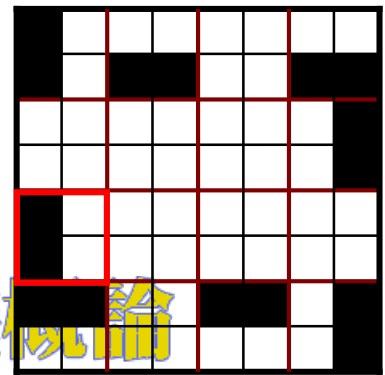

旋轉式視覺密碼

(Wu and Chen, 1998)

p_1	□	□	■	■	□	□	■	■	□	□	■	■	□	□	■	■
p_2	□	■	□	■	□	■	□	■	□	■	□	■	□	■	□	■
s_1	■	■	■	■	■	■	■	■	■	■	■	■	■	■	■	■
s_2	■	■	■	■	■	■	■	■	■	■	■	■	■	■	■	■

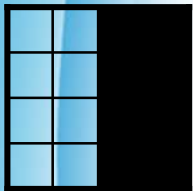

P_1

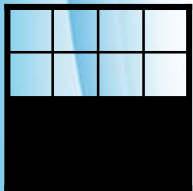
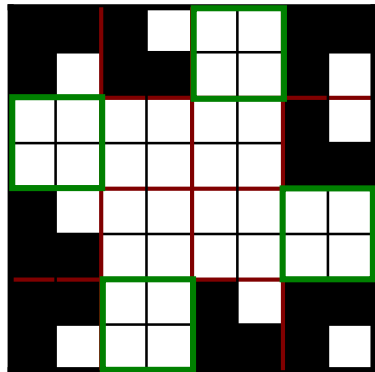

P_2

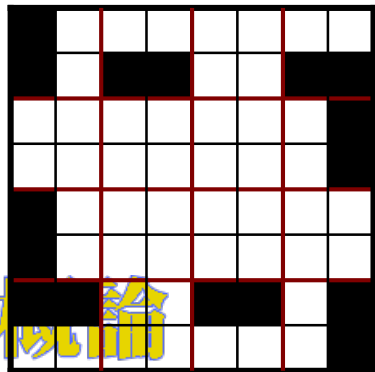

旋轉式視覺密碼

(Wu and Chen, 1998)

p_1	□	□	■	■	□	□	■	■	□	□	■	■	□	□	■	■
p_2	□	■	□	■	□	■	□	■	□	■	□	■	□	■	□	■
s_1	■	■	■	■	■	■	■	■	■	■	■	■	■	■	■	■
s_2	■	■	■	■	■	■	■	■	■	■	■	■	■	■	■	■

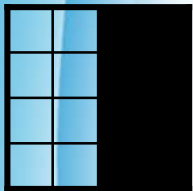

P_1

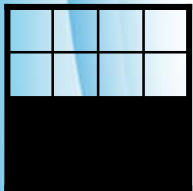
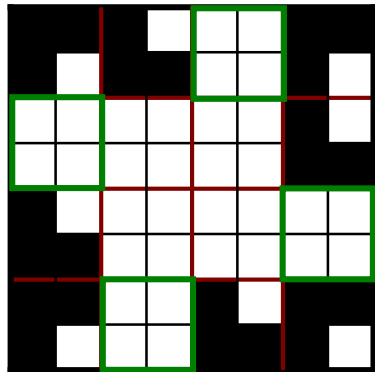

P_2

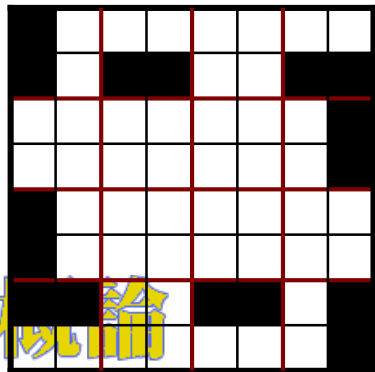

旋轉式視覺密碼

(Wu and Chen, 1998)

p_1	□	□	■	■	□	□	■	■	□	□	■	■	□	□	■	■
p_2	□	■	□	■	□	■	□	■	□	■	□	■	□	■	□	■
s_1	■	■	■	■	■	■	■	■	■	■	■	■	■	■	■	■
s_2	■	■	■	■	■	■	■	■	■	■	■	■	■	■	■	■

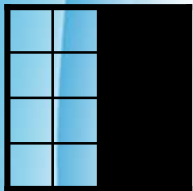

P_1

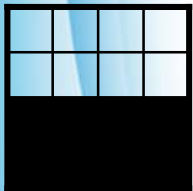
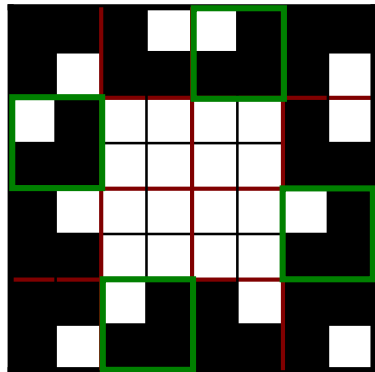

P_2

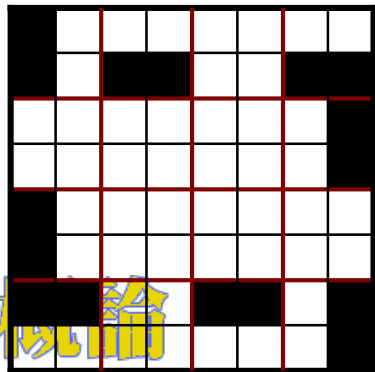

旋轉式視覺密碼

(Wu and Chen, 1998)

p_1	□	□	■	■	□	□	■	■	□	□	■	■	□	□	■	■
p_2	□	■	□	■	□	■	□	■	□	■	□	■	□	■	□	■
s_1	■	■	■	■	■	■	■	■	■	■	■	■	■	■	■	■
s_2	■	■	■	■	■	■	■	■	■	■	■	■	■	■	■	■

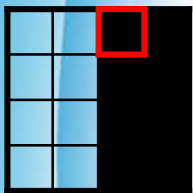

P_1

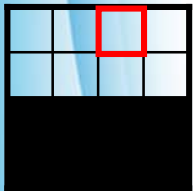
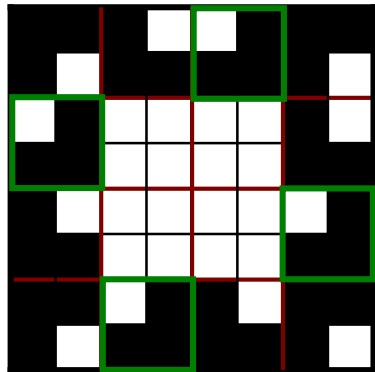

P_2

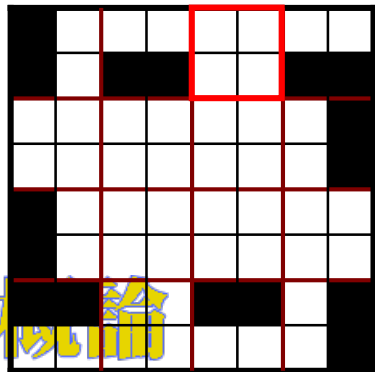

旋轉式視覺密碼

(Wu and Chen, 1998)

p_1	□	□	■	■	□	□	■	■	□	□	■	■	□	□	■	■
p_2	□	■	□	■	□	■	□	■	□	■	□	■	□	■	□	■
s_1	■	■	■	■	■	■	■	■	■	■	■	■	■	■	■	■
s_2	■	■	■	■	■	■	■	■	■	■	■	■	■	■	■	■

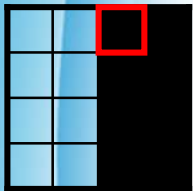

P_1

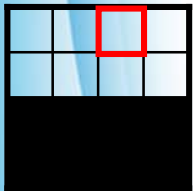
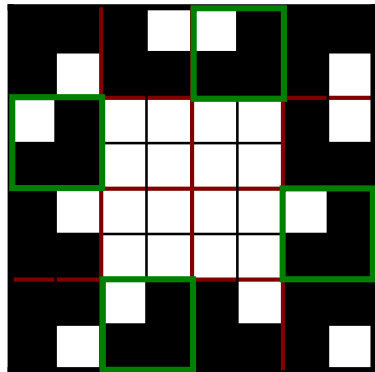

P_2

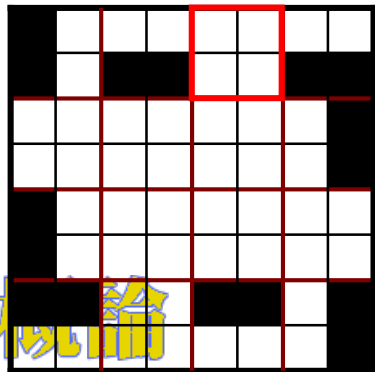

旋轉式視覺密碼

(Wu and Chen, 1998)

p_1	□	□	■	■	□	□	■	■	□	□	■	■	□	□	■	■
p_2	□	■	□	■	□	■	□	■	□	■	□	■	□	■	□	■
s_1	■	■	■	■	■	■	■	■	■	■	■	■	■	■	■	■
s_2	■	■	■	■	■	■	■	■	■	■	■	■	■	■	■	■

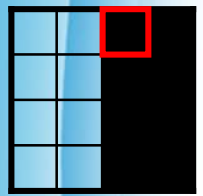

P_1

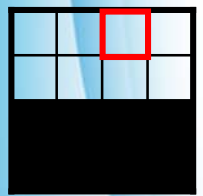
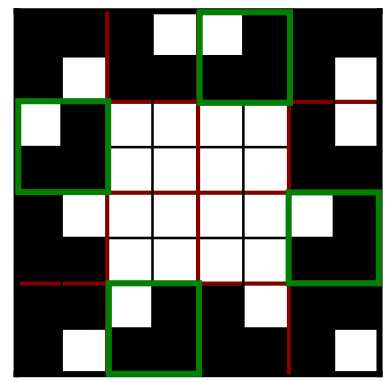

P_2

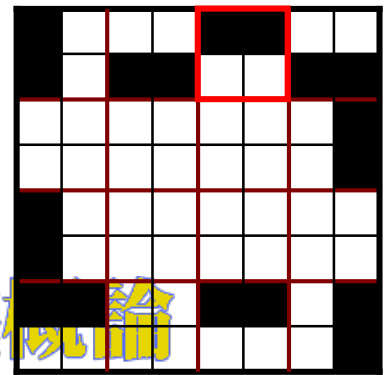

旋轉式視覺密碼

(Wu and Chen, 1998)

p_1	□	□	■	■	□	□	■	■	□	□	■	■	□	□	■	■
p_2	□	■	□	■	□	■	□	■	□	■	□	■	□	■	□	■
s_1	■	■	■	■	■	■	■	■	■	■	■	■	■	■	■	■
s_2	■	■	■	■	■	■	■	■	■	■	■	■	■	■	■	■

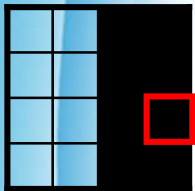

P_1

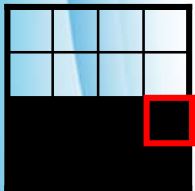
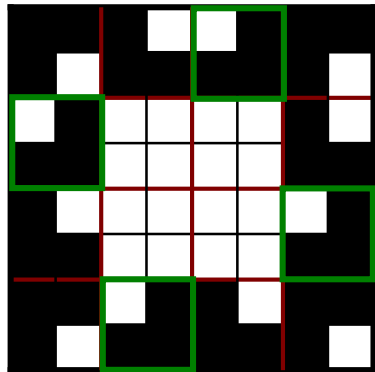

P_2

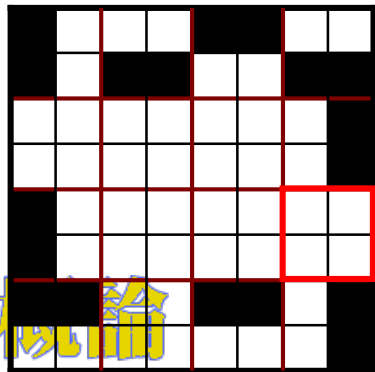

旋轉式視覺密碼

(Wu and Chen, 1998)

p_1	□	□	■	■	□	□	■	■	□	□	■	■	□	□	■	■
p_2	□	■	□	■	□	■	□	■	□	■	□	■	□	■	□	■
s_1	■	■	■	■	■	■	■	■	■	■	■	■	■	■	■	■
s_2	■	■	■	■	■	■	■	■	■	■	■	■	■	■	■	■

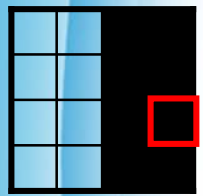

P_1

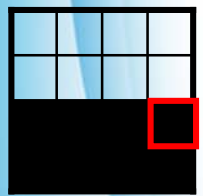
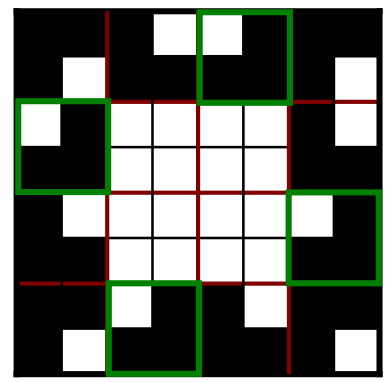

P_2

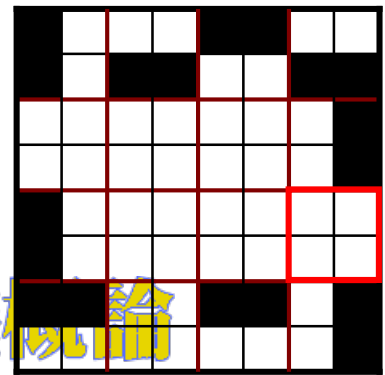

旋轉式視覺密碼

(Wu and Chen, 1998)

p_1	□	□	■	■	□	□	■	■	□	□	■	■	□	□	■	■
p_2	□	■	□	■	□	■	□	■	□	■	□	■	□	■	□	■
s_1	■	■	■	■	■	■	■	■	■	■	■	■	■	■	■	■
s_2	■	■	■	■	■	■	■	■	■	■	■	■	■	■	■	■

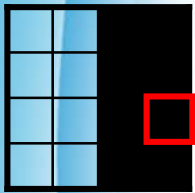

P_1

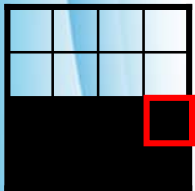
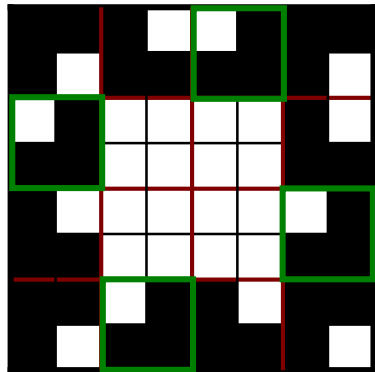

P_2

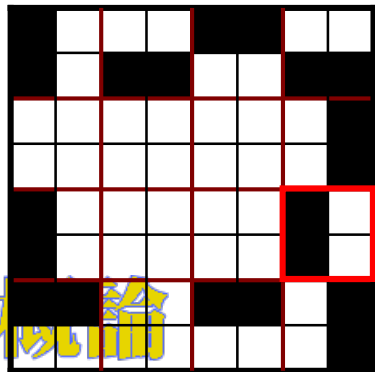

旋轉式視覺密碼

(Wu and Chen, 1998)

p_1	□	□	■	■	□	□	■	■	□	□	■	■	□	□	■	■
p_2	□	■	□	■	□	■	□	■	□	■	□	■	□	■	□	■
s_1	■	■	■	■	■	■	■	■	■	■	■	■	■	■	■	■
s_2	■	■	■	■	■	■	■	■	■	■	■	■	■	■	■	■

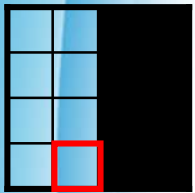

P_1

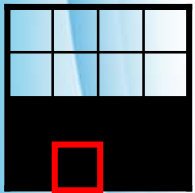
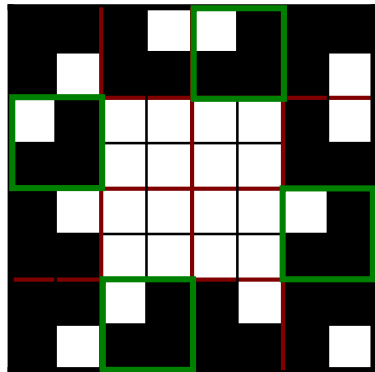

P_2

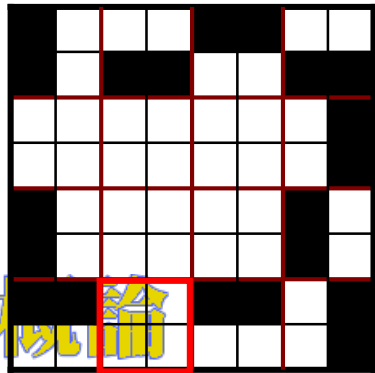

計算機概論



旋轉式視覺密碼

(Wu and Chen, 1998)

p_1	□	□	■	■	□	□	■	■	□	□	■	■	□	□	■	■
p_2	□	■	□	■	□	■	□	■	□	■	□	■	□	■	□	■
s_1	■	■	■	■	■	■	■	■	■	■	■	■	■	■	■	■
s_2	■	■	■	■	■	■	■	■	■	■	■	■	■	■	■	■

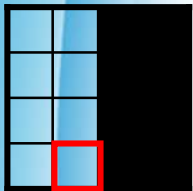

P_1

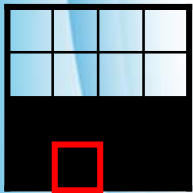
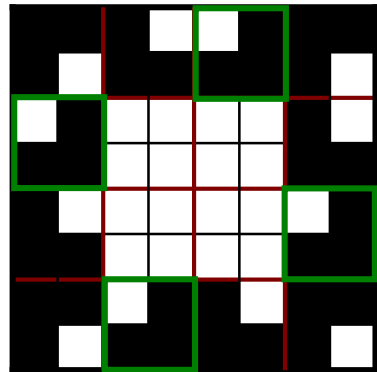

P_2

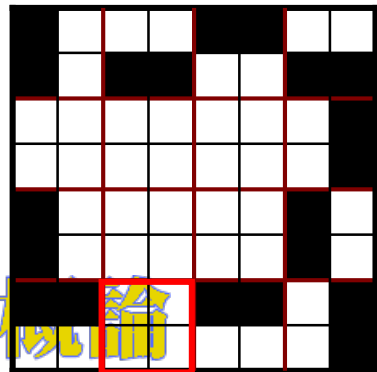

旋轉式視覺密碼

(Wu and Chen, 1998)

p_1	□	□	■	■	□	□	■	■	□	□	■	■	□	□	■	■
p_2	□	■	□	■	□	■	□	■	□	■	□	■	□	■	□	■
s_1	■	■	■	■	■	■	■	■	■	■	■	■	■	■	■	■
s_2	■	■	■	■	■	■	■	■	■	■	■	■	■	■	■	■

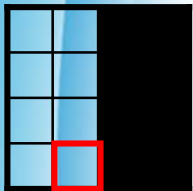

P_1

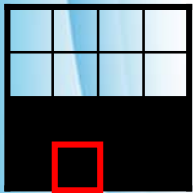
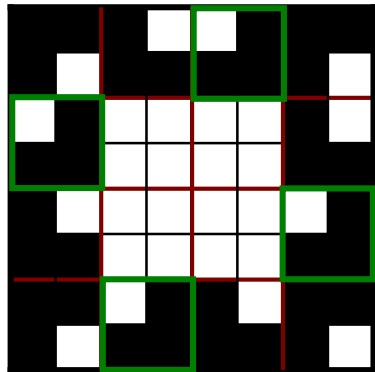

P_2

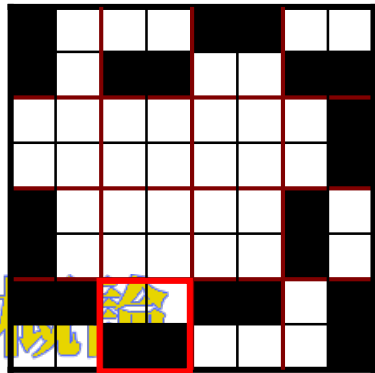

旋轉式視覺密碼

(Wu and Chen, 1998)

p_1	□	□	■	■	□	□	■	■	□	□	■	■	□	□	■	■
p_2	□	■	□	■	□	■	□	■	□	■	□	■	□	■	□	■
s_1	■	■	■	■	■	■	■	■	■	■	■	■	■	■	■	■
s_2	■	■	■	■	■	■	■	■	■	■	■	■	■	■	■	■

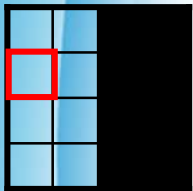

P_1

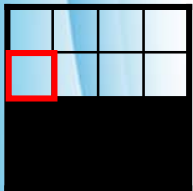
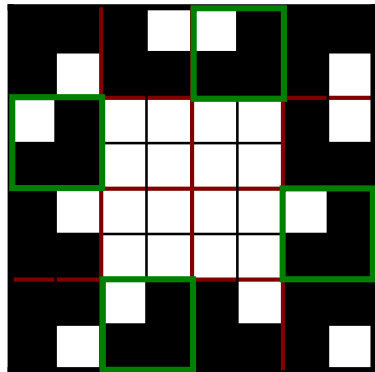

P_2

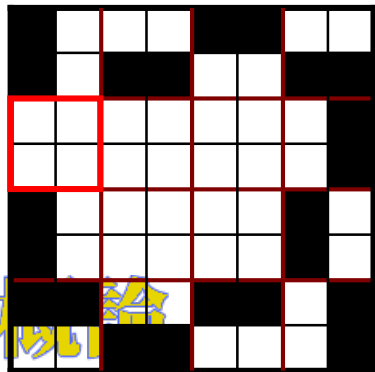

旋轉式視覺密碼

(Wu and Chen, 1998)

p_1	□	□	■	■	□	□	■	■	□	□	■	■	□	□	■	■
p_2	□	■	□	■	□	■	□	■	□	■	□	■	□	■	□	■
s_1	■	■	■	■	■	■	■	■	■	■	■	■	■	■	■	■
s_2	■	■	■	■	■	■	■	■	■	■	■	■	■	■	■	■

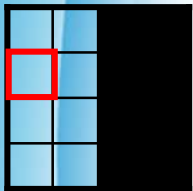

P_1

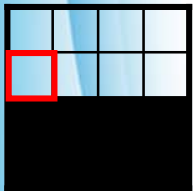
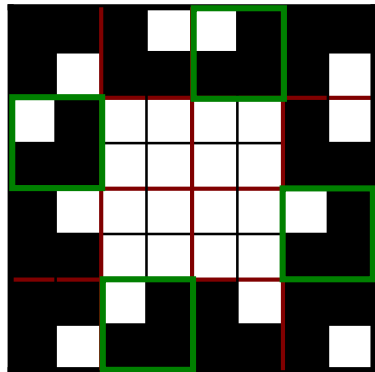

P_2

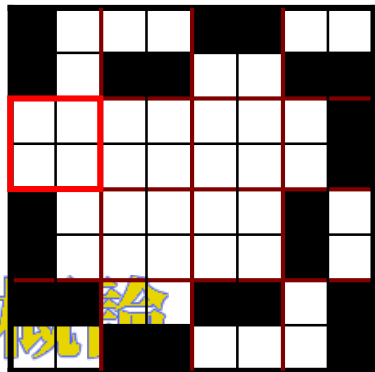

旋轉式視覺密碼

(Wu and Chen, 1998)

p_1	□	□	■	■	□	□	■	■	□	□	■	■	□	□	■	■
p_2	□	■	□	■	□	■	□	■	□	■	□	■	□	■	□	■
s_1	■	■	■	■	■	■	■	■	■	■	■	■	■	■	■	■
s_2	■	■	■	■	■	■	■	■	■	■	■	■	■	■	■	■

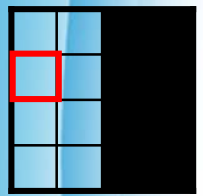

P_1

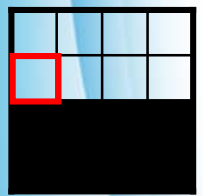
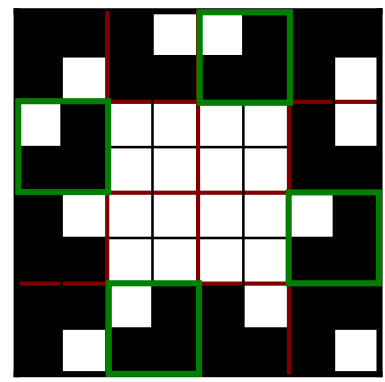

P_2

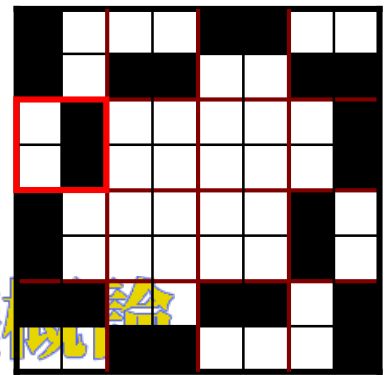

旋轉式視覺密碼

(Wu and Chen, 1998)

p_1	□	□	■	■	□	□	■	■	□	□	■	■	□	□	■	■
p_2	□	■	□	■	□	■	□	■	□	■	□	■	□	■	□	■
s_1	■	■	■	■	■	■	■	■	■	■	■	■	■	■	■	■
s_2	■	■	■	■	■	■	■	■	■	■	■	■	■	■	■	■

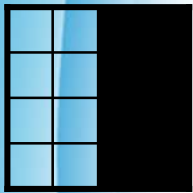

P_1

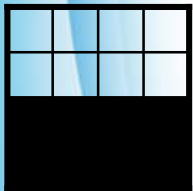
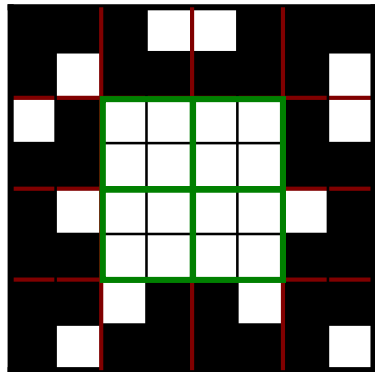

P_2

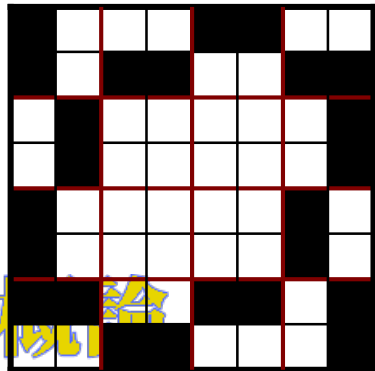

旋轉式視覺密碼

(Wu and Chen, 1998)

p_1	□	□	■	■	□	□	■	■	□	□	■	■	□	□	■	■
p_2	□	■	□	■	□	■	□	■	□	■	□	■	□	■	□	■
s_1	■	■	■	■	■	■	■	■	■	■	■	■	■	■	■	■
s_2	■	■	■	■	■	■	■	■	■	■	■	■	■	■	■	■

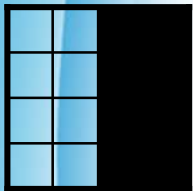

P_1

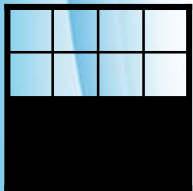
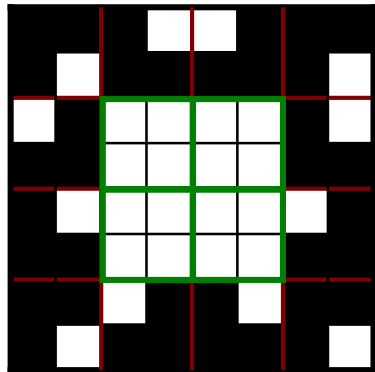

P_2

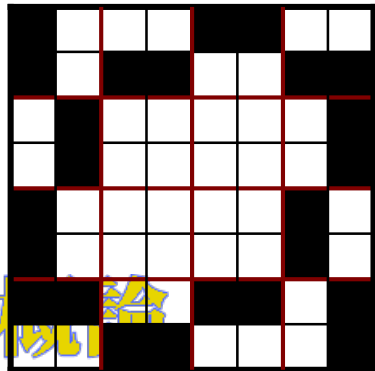

旋轉式視覺密碼

(Wu and Chen, 1998)

p_1	□	□	■	■	□	□	■	■	□	□	■	■	□	□	■	■
p_2	□	■	□	■	□	■	□	■	□	■	□	■	□	■	□	■
s_1	■	■	■	■	■	■	■	■	■	■	■	■	■	■	■	■
s_2	■	■	■	■	■	■	■	■	■	■	■	■	■	■	■	■

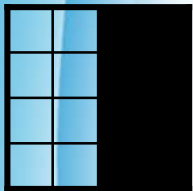

P_1

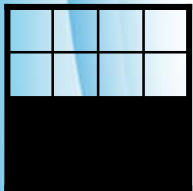
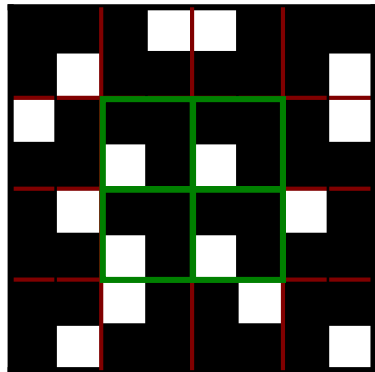

P_2

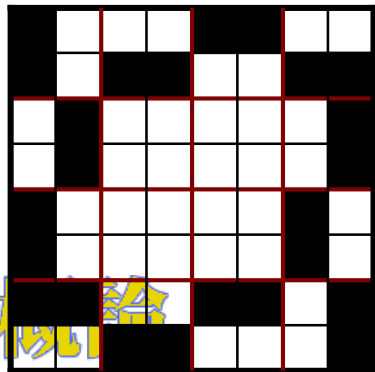

旋轉式視覺密碼

(Wu and Chen, 1998)

p_1	□	□	■	■	□	□	■	■	□	□	■	■	□	□	■	■
p_2	□	■	□	■	□	■	□	■	□	■	□	■	□	■	□	■
s_1	■	■	■	■	■	■	■	■	■	■	■	■	■	■	■	■
s_2	■	■	■	■	■	■	■	■	■	■	■	■	■	■	■	■

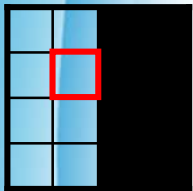

P_1

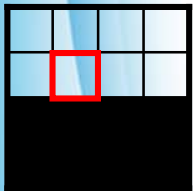
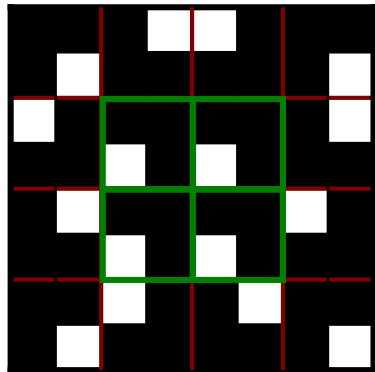

P_2

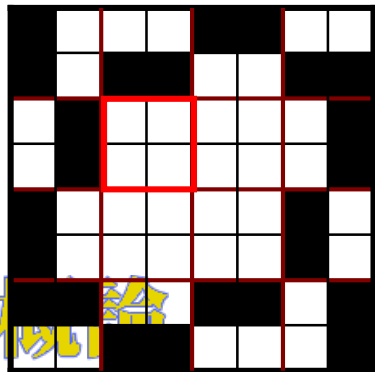

旋轉式視覺密碼

(Wu and Chen, 1998)

p_1	□	□	■	■	□	□	■	■	□	□	■	■	□	□	■	■
p_2	□	■	□	■	□	■	□	■	□	■	□	■	□	■	□	■
s_1	■	■	■	■	■	■	■	■	■	■	■	■	■	■	■	■
s_2	■	■	■	■	■	■	■	■	■	■	■	■	■	■	■	■

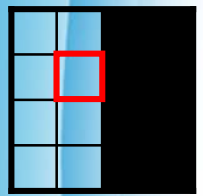

P_1

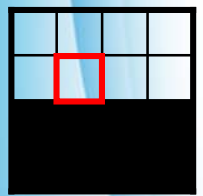
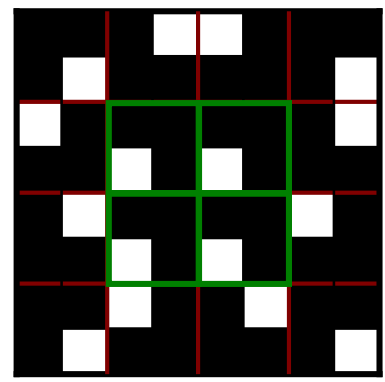

P_2

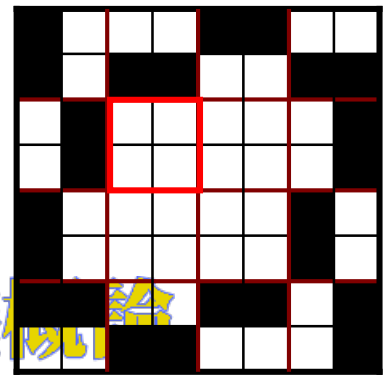

旋轉式視覺密碼

(Wu and Chen, 1998)

p_1	□	□	■	■	□	□	■	■	□	□	■	■	□	□	■	■
p_2	□	■	□	■	□	■	□	■	□	■	□	■	□	■	□	■
s_1	■	■	■	■	■	■	■	■	■	■	■	■	■	■	■	■
s_2	■	■	■	■	■	■	■	■	■	■	■	■	■	■	■	■

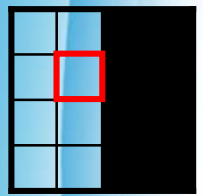

P_1

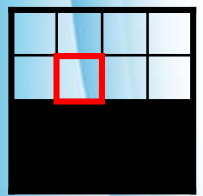
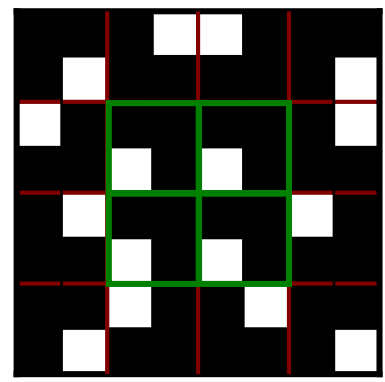

P_2

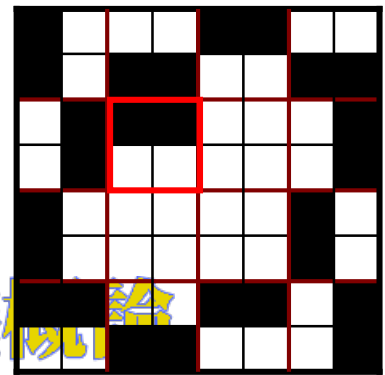

旋轉式視覺密碼

(Wu and Chen, 1998)

p_1	□	□	■	■	□	□	■	■	□	□	■	■	□	□	■	■
p_2	□	■	□	■	□	■	□	■	□	■	□	■	□	■	□	■
s_1	■	■	■	■	■	■	■	■	■	■	■	■	■	■	■	■
s_2	■	■	■	■	■	■	■	■	■	■	■	■	■	■	■	■

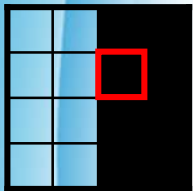

P_1

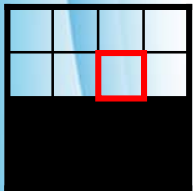
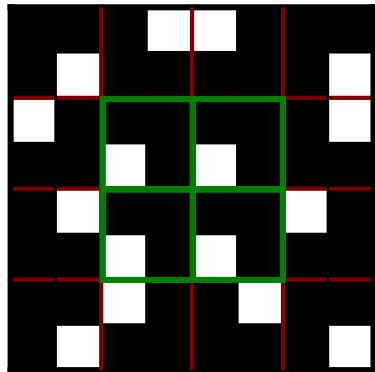

P_2

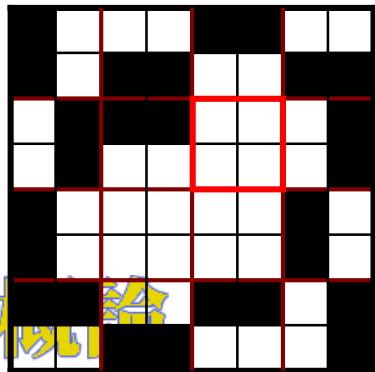

旋轉式視覺密碼

(Wu and Chen, 1998)

p_1	□	□	■	■	□	□	■	■	□	□	■	■	□	□	■	■
p_2	□	■	□	■	□	■	□	■	□	■	□	■	□	■	□	■
s_1	■	■	■	■	■	■	■	■	■	■	■	■	■	■	■	■
s_2	■	■	■	■	■	■	■	■	■	■	■	■	■	■	■	■

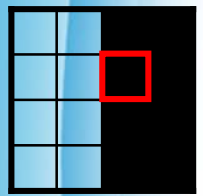

P_1

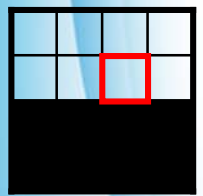
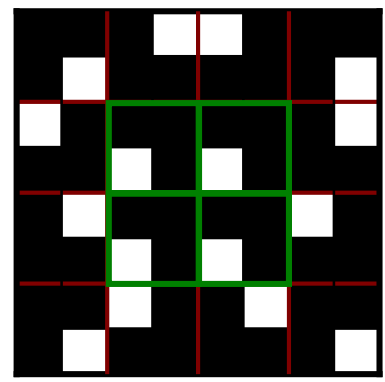

P_2

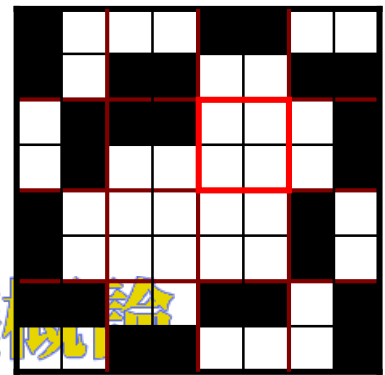

旋轉式視覺密碼

(Wu and Chen, 1998)

p_1	□	□	■	■	□	□	■	■	□	□	■	■	□	□	■	■
p_2	□	■	□	■	□	■	□	■	□	■	□	■	□	■	□	■
s_1	■	■	■	■	■	■	■	■	■	■	■	■	■	■	■	■
s_2	■	■	■	■	■	■	■	■	■	■	■	■	■	■	■	■

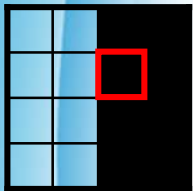

P_1

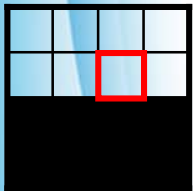
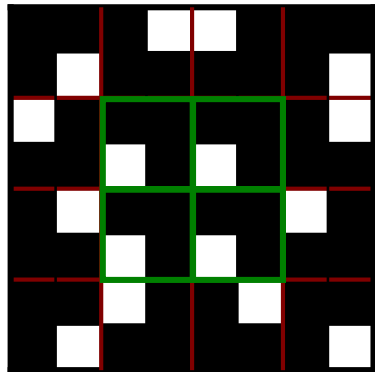

P_2

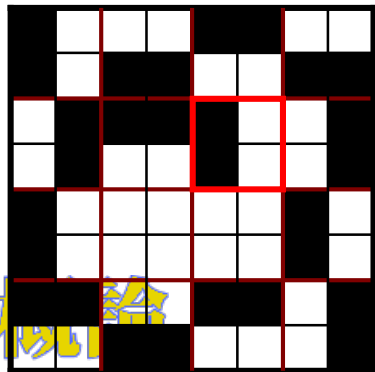

旋轉式視覺密碼

(Wu and Chen, 1998)

p_1	□	□	■	■	□	□	■	■	□	□	■	■	□	□	■	■
p_2	□	■	□	■	□	■	□	■	□	■	□	■	□	■	□	■
s_1	■	■	■	■	■	■	■	■	■	■	■	■	■	■	■	■
s_2	■	■	■	■	■	■	■	■	■	■	■	■	■	■	■	■

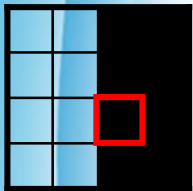

P_1

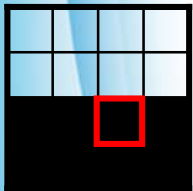
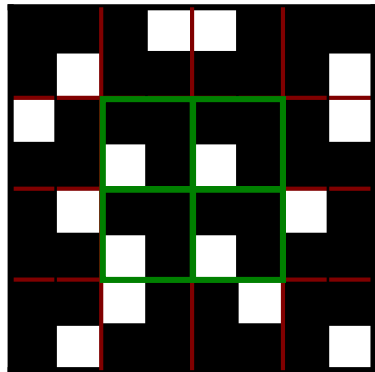

P_2

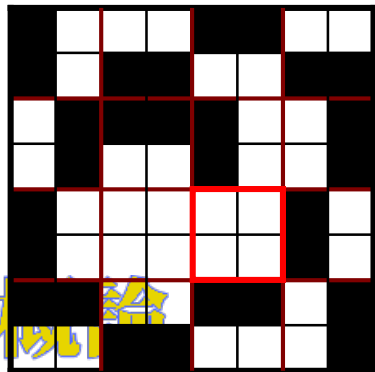

旋轉式視覺密碼

(Wu and Chen, 1998)

p_1	□	□	■	■	□	□	■	■	□	□	■	■	□	□	■	■
p_2	□	■	□	■	□	■	□	■	□	■	□	■	□	■	□	■
s_1	■	■	■	■	■	■	■	■	■	■	■	■	■	■	■	■
s_2	■	■	■	■	■	■	■	■	■	■	■	■	■	■	■	■

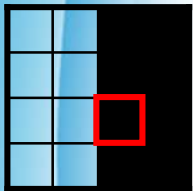

P_1

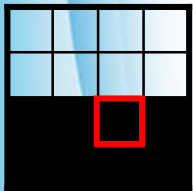
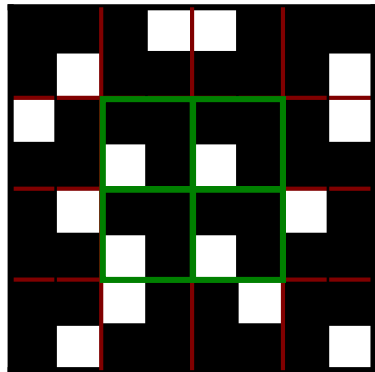

P_2

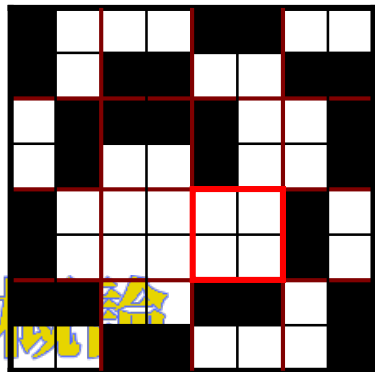

旋轉式視覺密碼

(Wu and Chen, 1998)

p_1	□	□	■	■	□	□	■	■	□	□	■	■	□	□	■	■
p_2	□	■	□	■	□	■	□	■	□	■	□	■	□	■	□	■
s_1	■	■	■	■	■	■	■	■	■	■	■	■	■	■	■	■
s_2	■	■	■	■	■	■	■	■	■	■	■	■	■	■	■	■

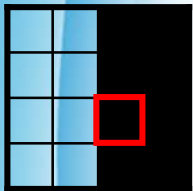

P_1

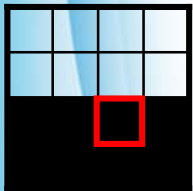
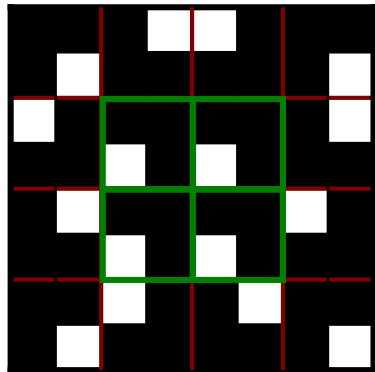

P_2

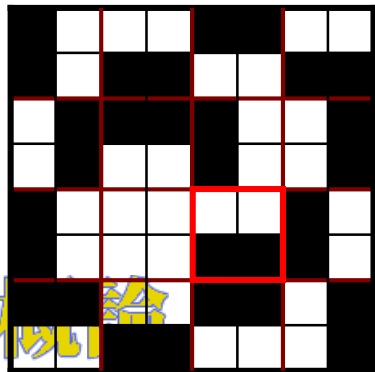

旋轉式視覺密碼

(Wu and Chen, 1998)

p_1	□	□	■	■	□	□	■	■	□	□	■	■	□	□	■	■
p_2	□	■	□	■	□	■	□	■	□	■	□	■	□	■	□	■
s_1	■	■	■	■	■	■	■	■	■	■	■	■	■	■	■	■
s_2	■	■	■	■	■	■	■	■	■	■	■	■	■	■	■	■

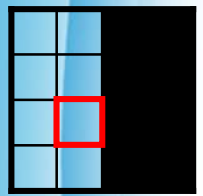

P_1

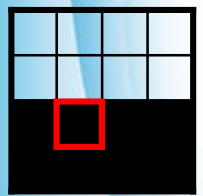
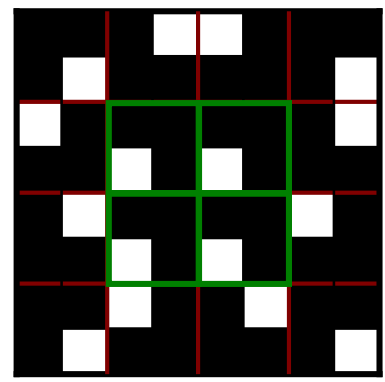

P_2

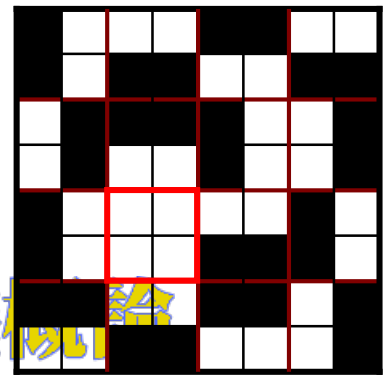

旋轉式視覺密碼

(Wu and Chen, 1998)

p_1	□	□	■	■	□	□	■	■	□	□	■	■	□	□	■	■
p_2	□	■	□	■	□	■	□	■	□	■	□	■	□	■	□	■
s_1	■	■	■	■	■	■	■	■	■	■	■	■	■	■	■	■
s_2	■	■	■	■	■	■	■	■	■	■	■	■	■	■	■	■

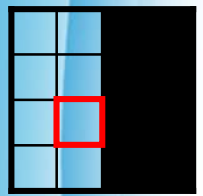

P_1

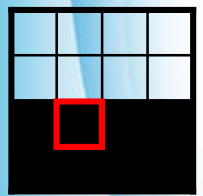
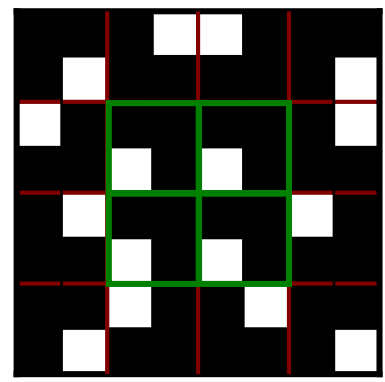

P_2

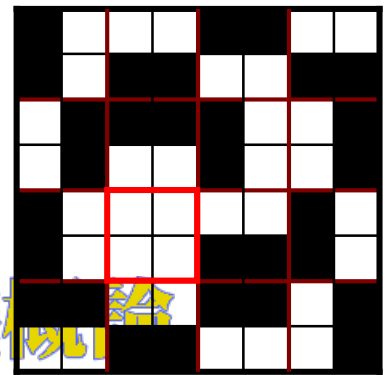

旋轉式視覺密碼

(Wu and Chen, 1998)

p_1	□	□	■	■	□	□	■	■	□	□	■	■	□	□	■	■
p_2	□	■	□	■	□	■	□	■	□	■	□	■	□	■	□	■
s_1	■	■	■	■	■	■	■	■	■	■	■	■	■	■	■	■
s_2	■	■	■	■	■	■	■	■	■	■	■	■	■	■	■	■

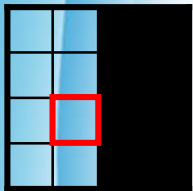

P_1

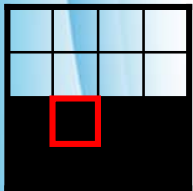
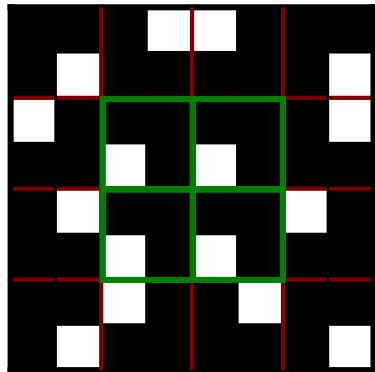

P_2

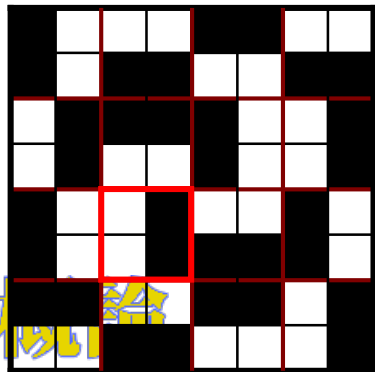

旋轉式視覺密碼

(Wu and Chen, 1998)

p_1	□	□	■	■	□	□	■	■	□	□	■	■	□	□	■	■
p_2	□	■	□	■	□	■	□	■	□	■	□	■	□	■	□	■
s_1	■	■	■	■	■	■	■	■	■	■	■	■	■	■	■	■
s_2	■	■	■	■	■	■	■	■	■	■	■	■	■	■	■	■

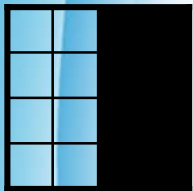

P_1

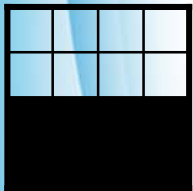
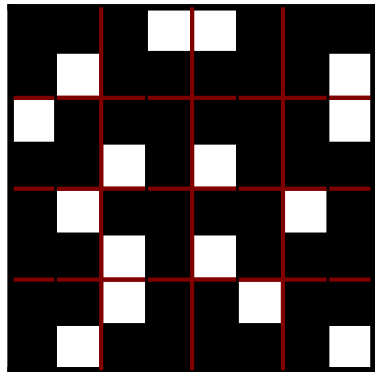

P_2

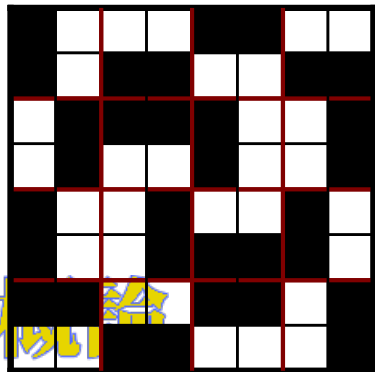

旋轉式視覺密碼

(Wu and Chen, 1998)

p_1	□	□	■	■	□	□	■	■	□	□	■	■	□	□	■	■
p_2	□	■	□	■	□	■	□	■	□	■	□	■	□	■	□	■
s_1	■	■	■	■	■	■	■	■	■	■	■	■	■	■	■	■
s_2	■	■	■	■	■	■	■	■	■	■	■	■	■	■	■	■

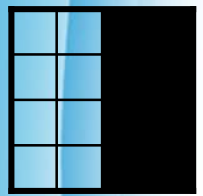

P_1

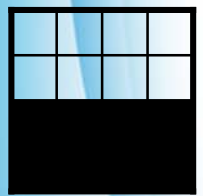
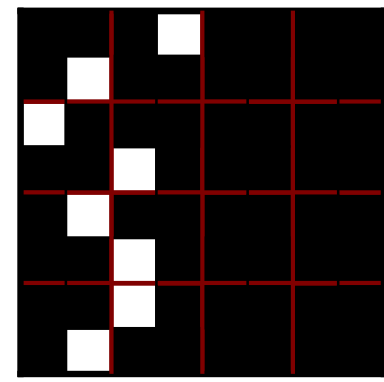
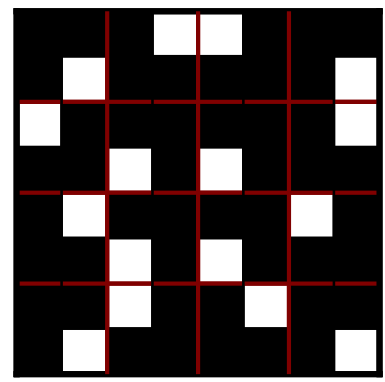

P_2

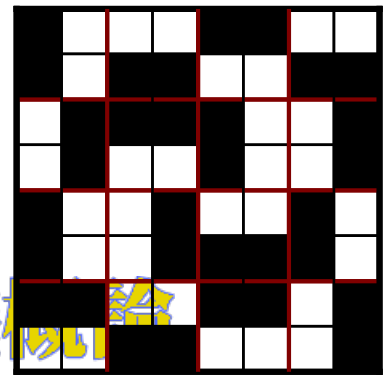

旋轉式視覺密碼

(Wu and Chen, 1998)

p_1	□	□	■	■	□	□	■	■	□	□	■	■	□	□	■	■
p_2	□	■	□	■	□	■	□	■	□	■	□	■	□	■	□	■
s_1	■	■	■	■	■	■	■	■	■	■	■	■	■	■	■	■
s_2	■	■	■	■	■	■	■	■	■	■	■	■	■	■	■	■

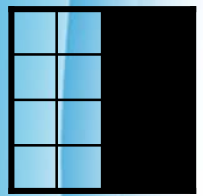

P_1

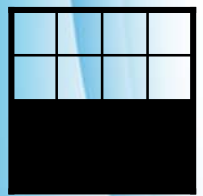
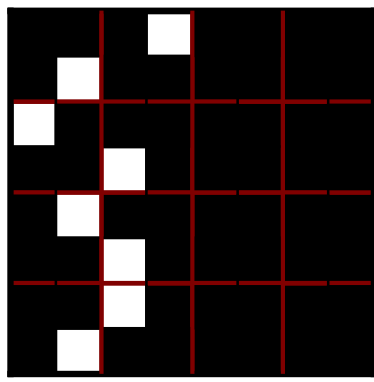
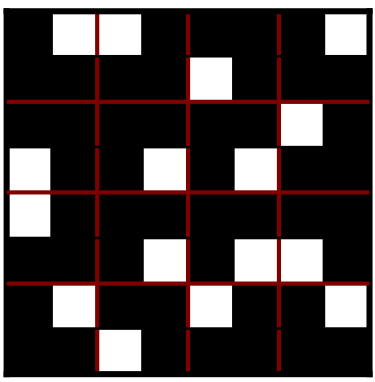

P_2

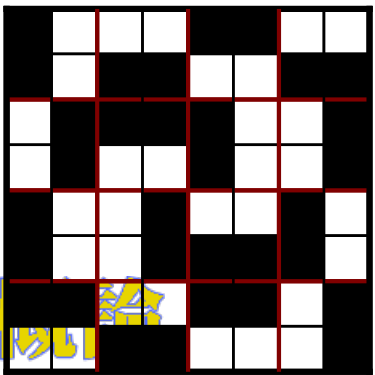

旋轉式視覺密碼

(Wu and Chen, 1998)

p_1	□	□	■	■	□	□	■	■	□	□	■	■	□	□	■	■
p_2	□	■	□	■	□	■	□	■	□	■	□	■	□	■	□	■
s_1	■	■	■	■	■	■	■	■	■	■	■	■	■	■	■	■
s_2	■	■	■	■	■	■	■	■	■	■	■	■	■	■	■	■

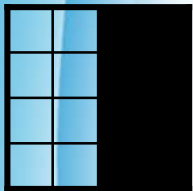

P_1

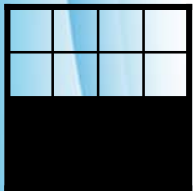

P_2

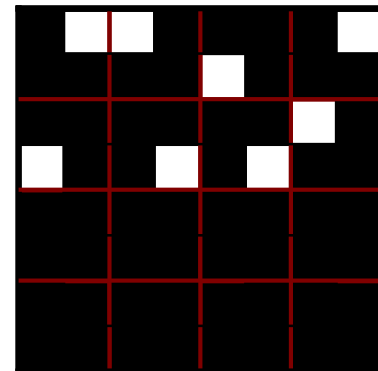
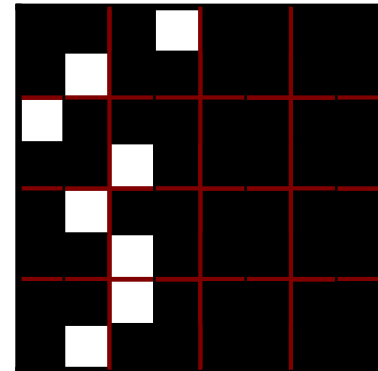

平移式視覺密碼

(Wu and Yang, 2001)

S_1

S_2

P_1

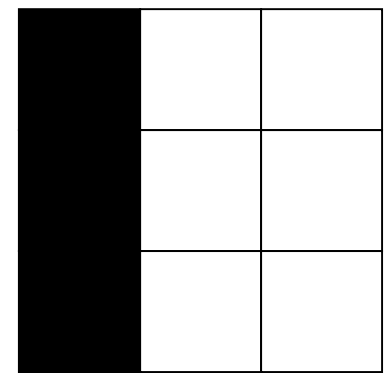
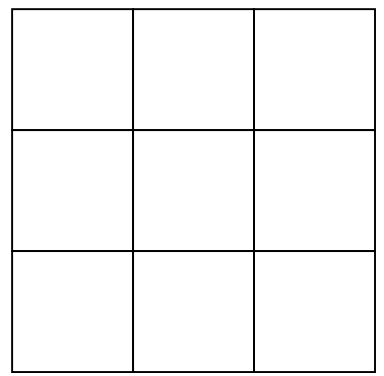
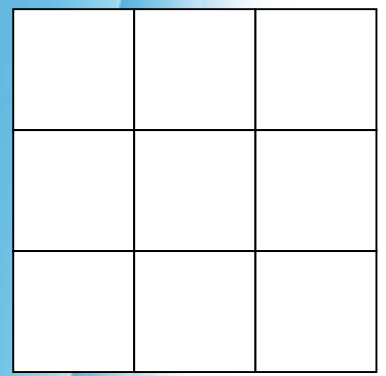

S_1

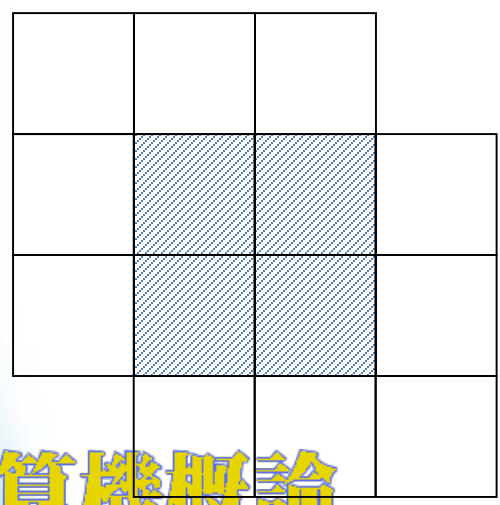

S_2

P_2

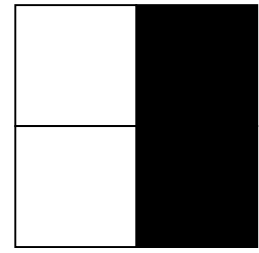

平移式視覺密碼

(Wu and Yang, 2001)

S_1

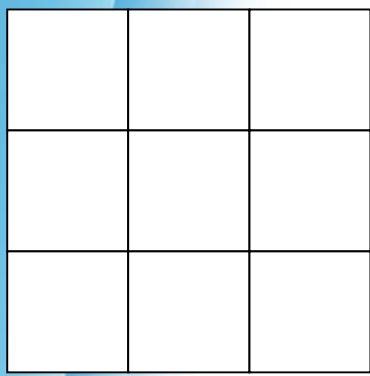

S_2

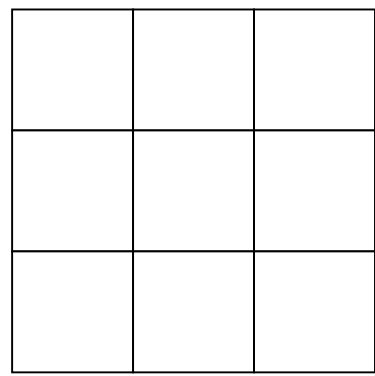

\otimes

P_1

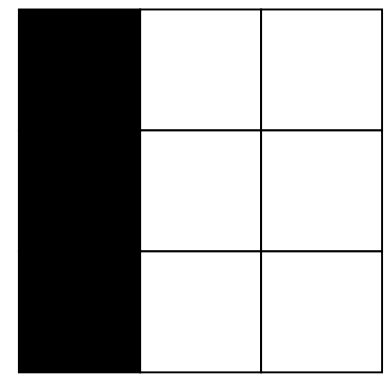

S_1

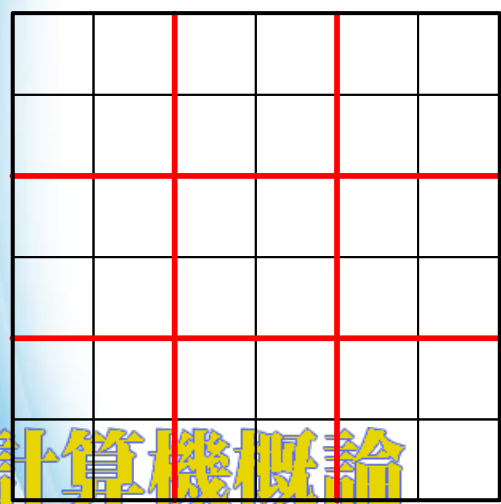

S_2

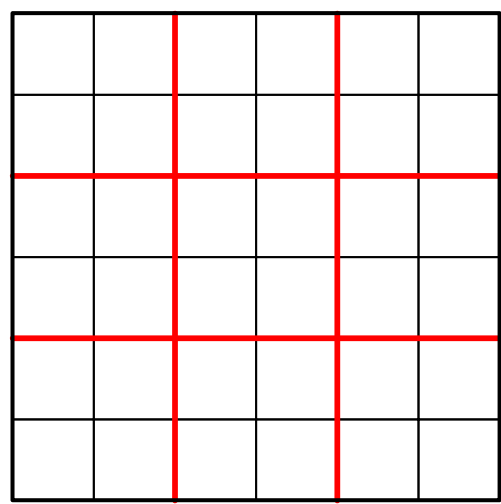

平移式視覺密碼

(Wu and Yang, 2001)

S_1

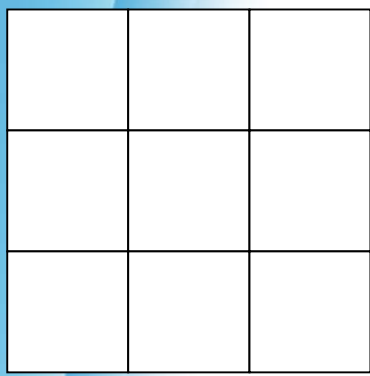

S_2

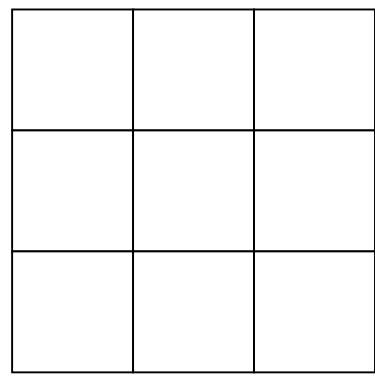

\otimes

P_1

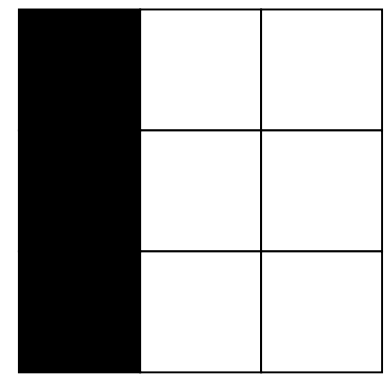

S_1

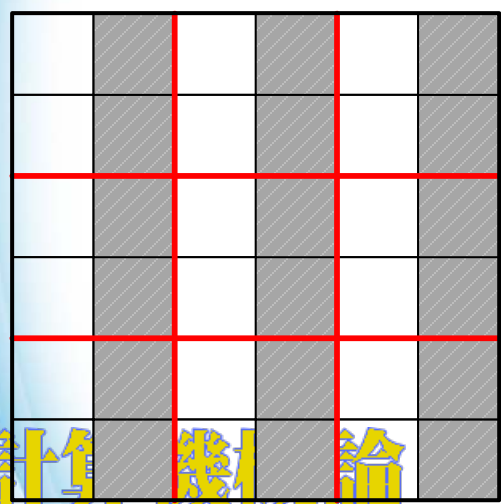

S_2

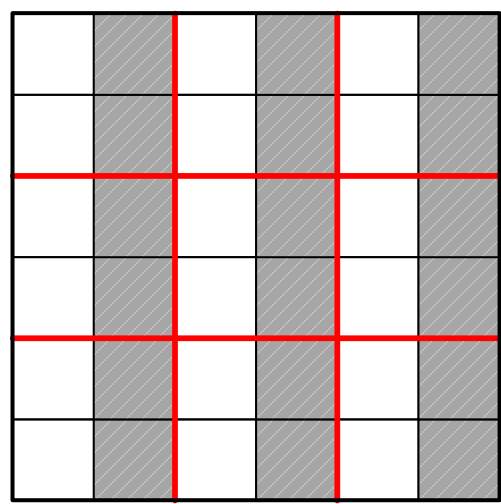

平移式視覺密碼

(Wu and Yang, 2001)

S_1

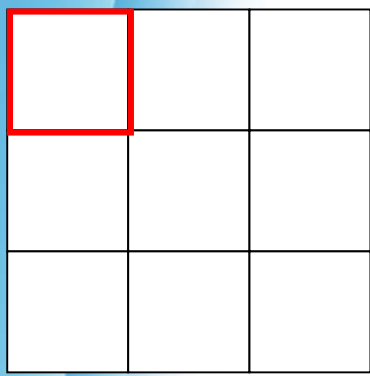

S_2

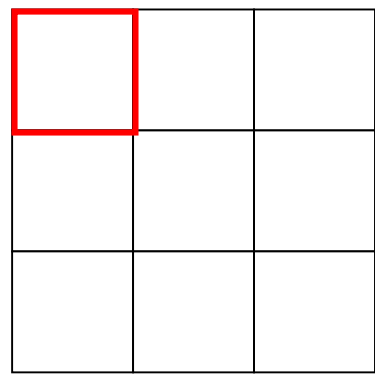

\otimes

P_1

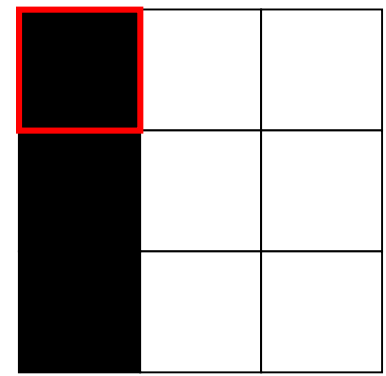

S_1

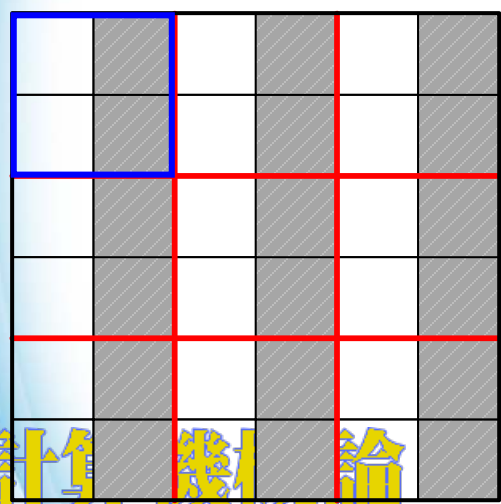

S_2

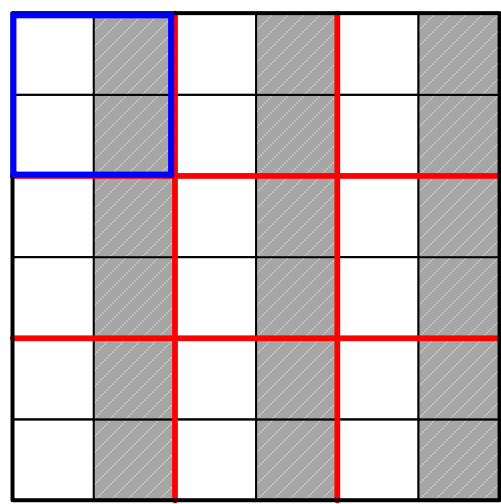

平移式視覺密碼

(Wu and Yang, 2001)

S_1

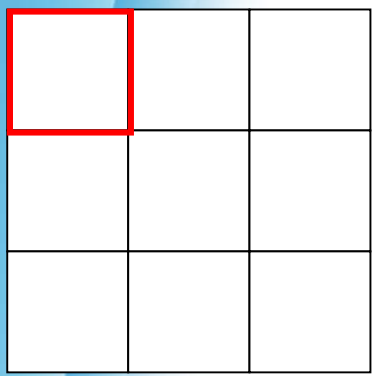

S_2

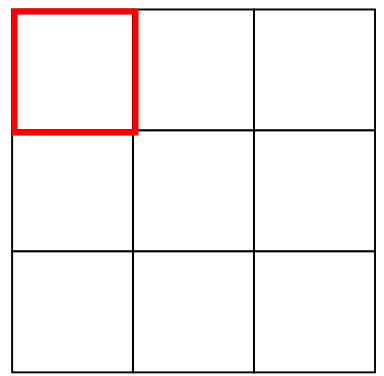

\otimes

P_1

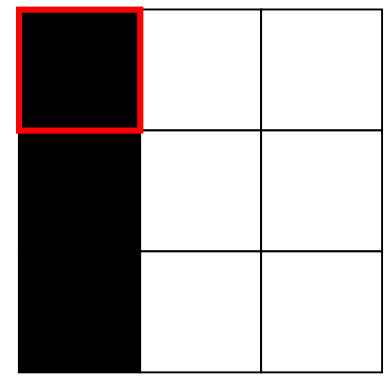

S_1

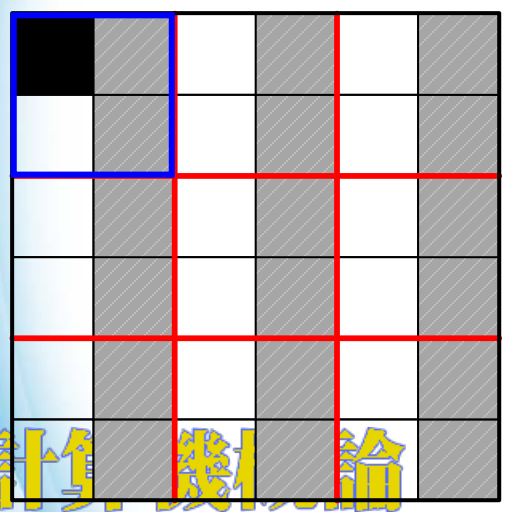

S_2

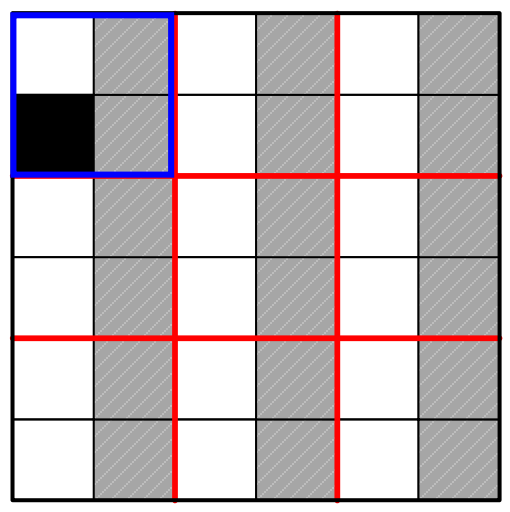

平移式視覺密碼

(Wu and Yang, 2001)

S_1

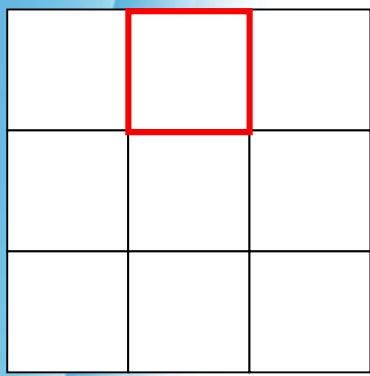

S_2

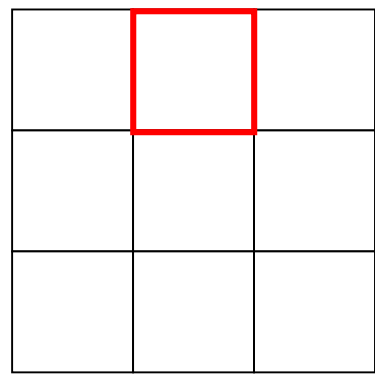

\otimes

P_1

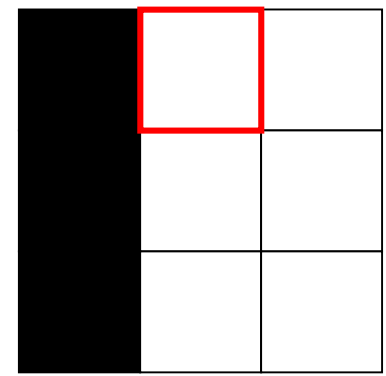

S_1

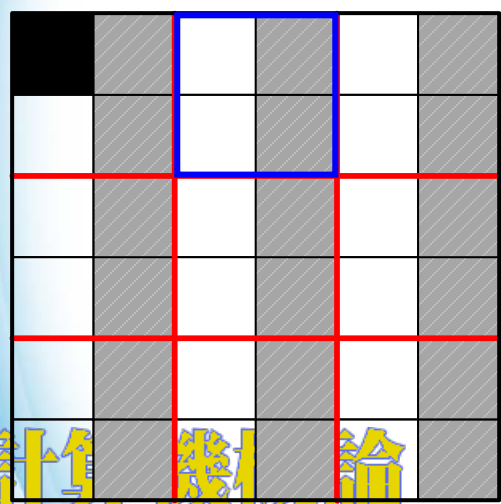

S_2

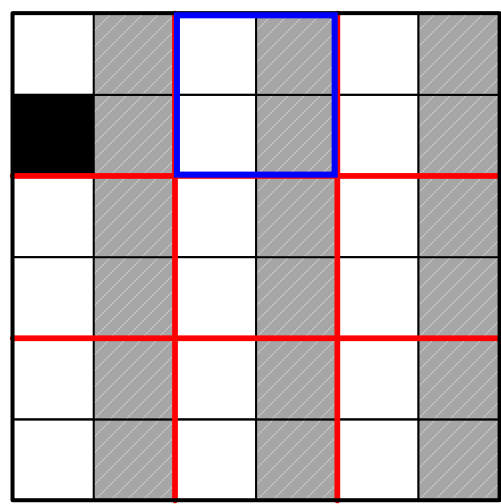

平移式視覺密碼

(Wu and Yang, 2001)

S_1

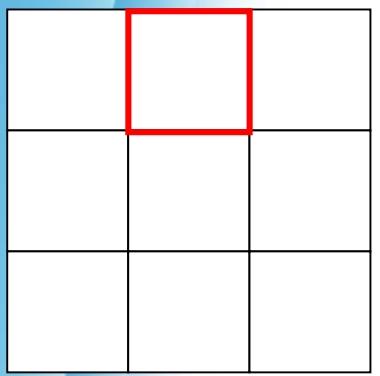

S_2

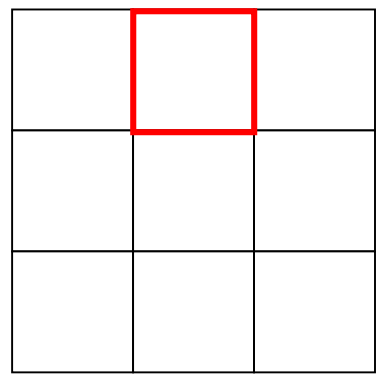

\otimes

P_1

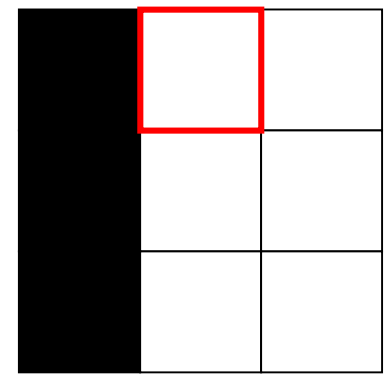

S_1

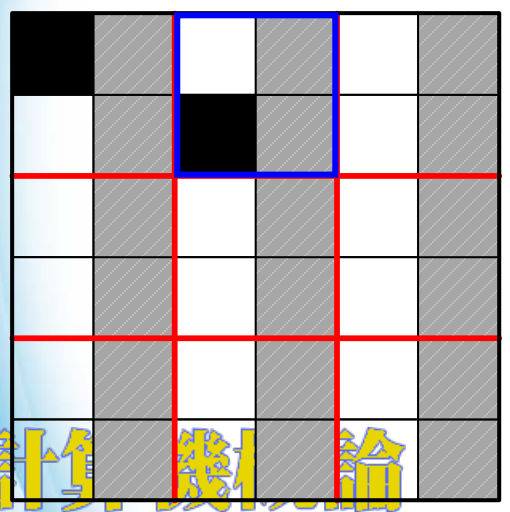

S_2

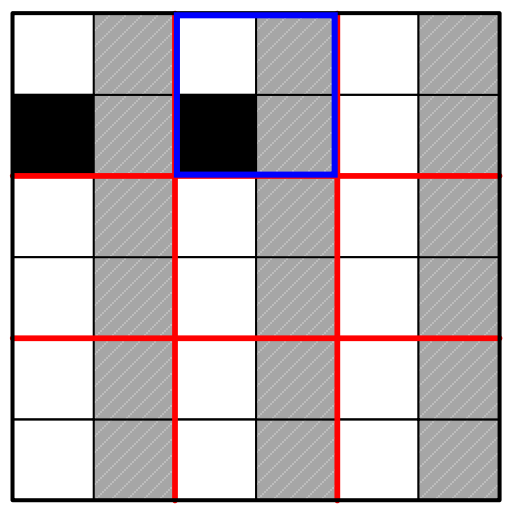

平移式視覺密碼

(Wu and Yang, 2001)

S_1

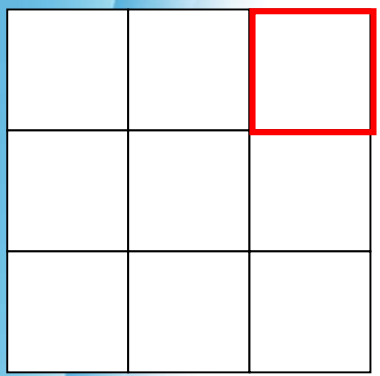

S_2

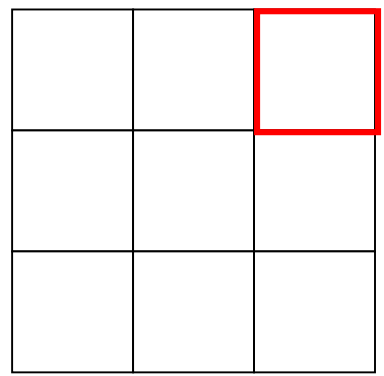

\otimes

P_1

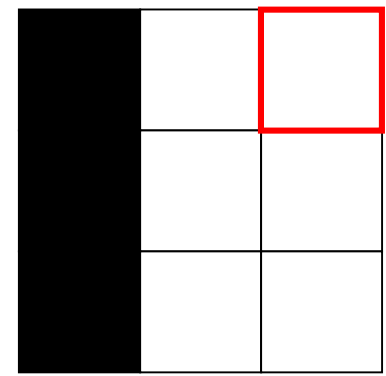

S_1

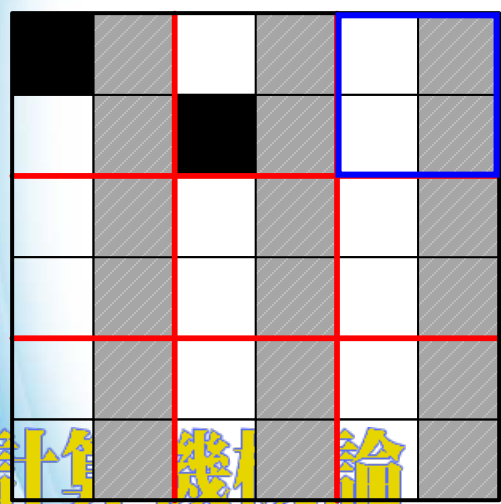

S_2

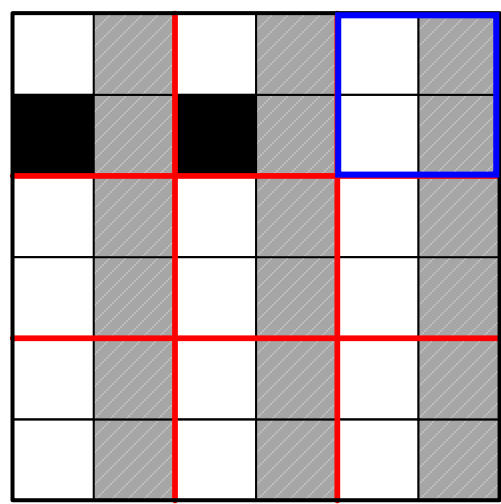

平移式視覺密碼

(Wu and Yang, 2001)

S_1

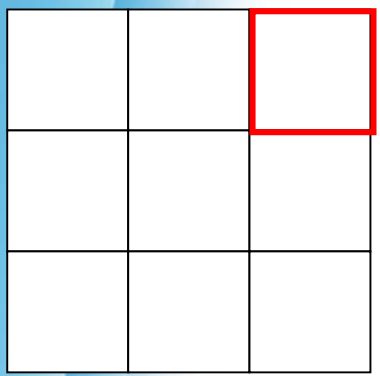

S_2

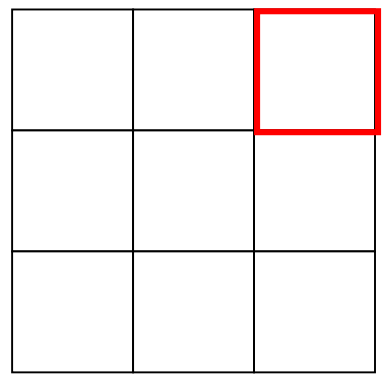

\otimes

P_1

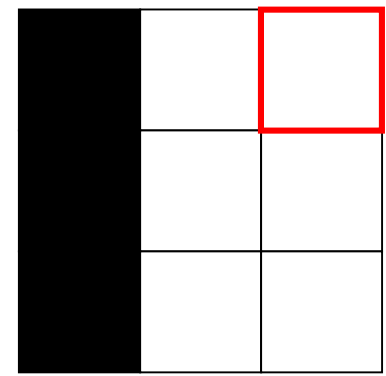

S_1

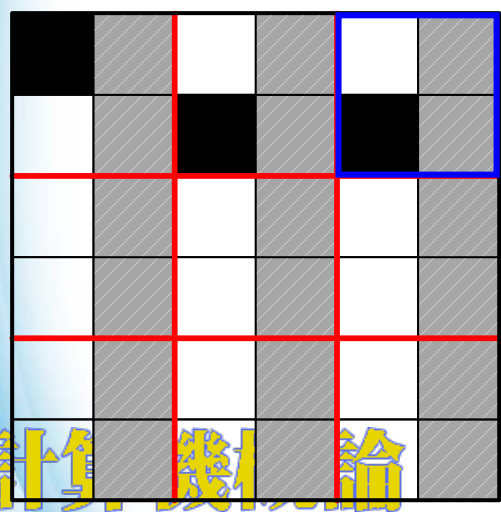

S_2

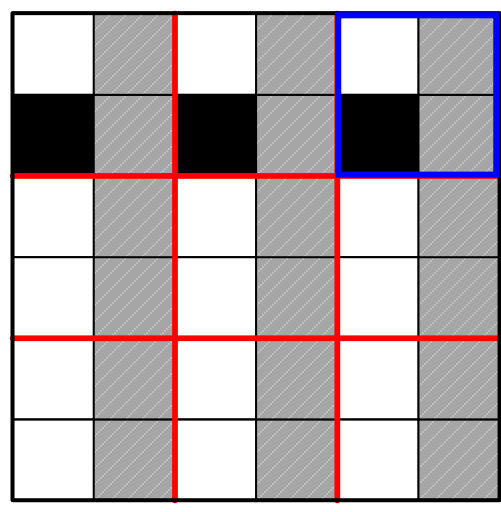

平移式視覺密碼

(Wu and Yang, 2001)

S_1

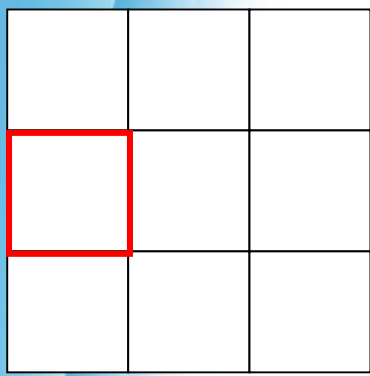

\otimes

S_2

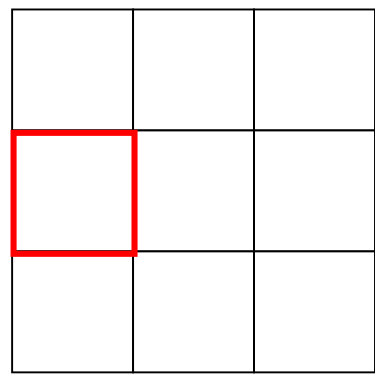

P_1

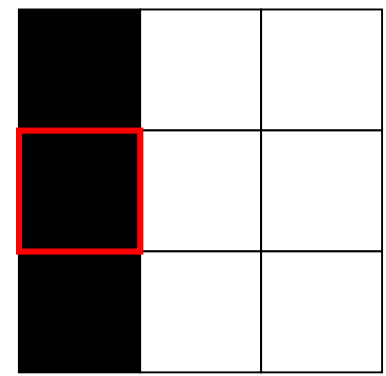

S_1

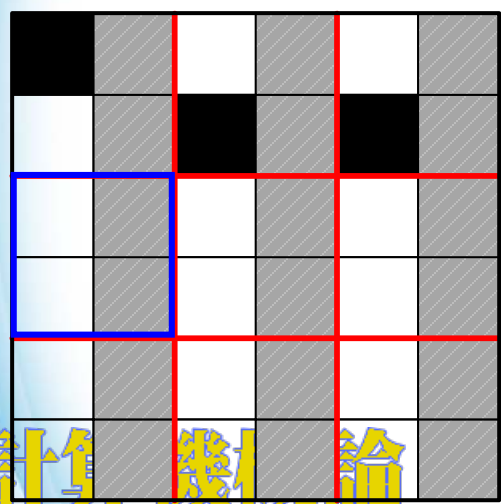

S_2

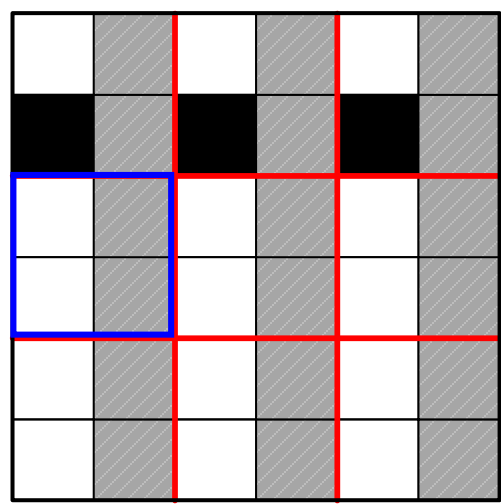

平移式視覺密碼

(Wu and Yang, 2001)

S_1

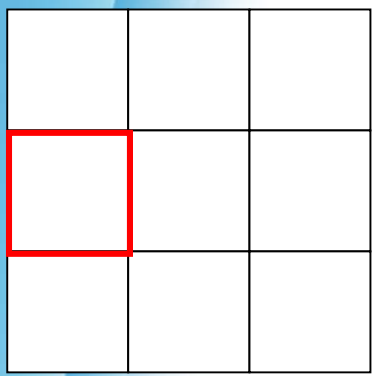

S_2

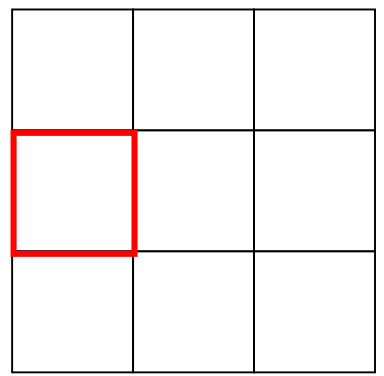

\otimes

P_1

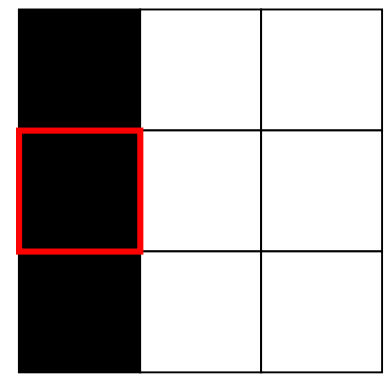

S_1

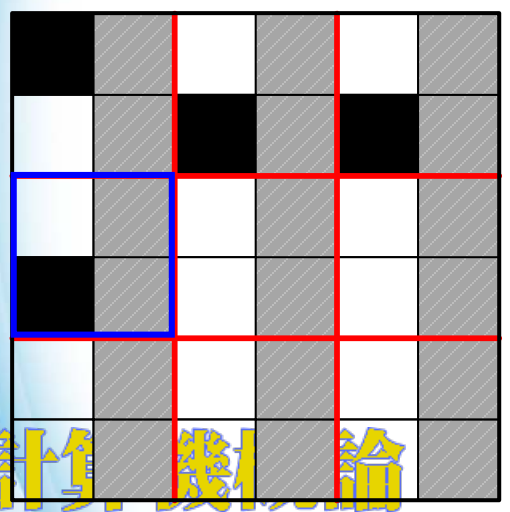

S_2

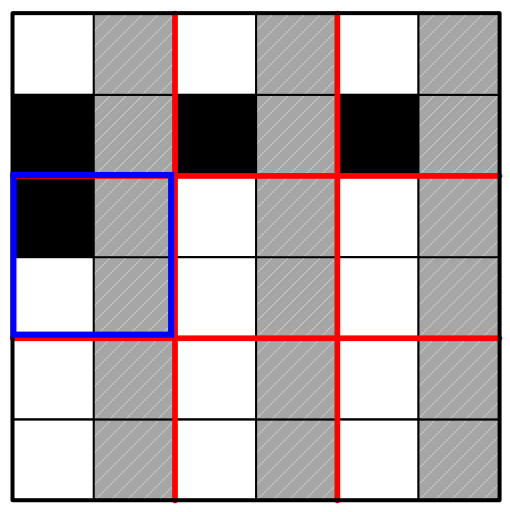

平移式視覺密碼

(Wu and Yang, 2001)

S_1

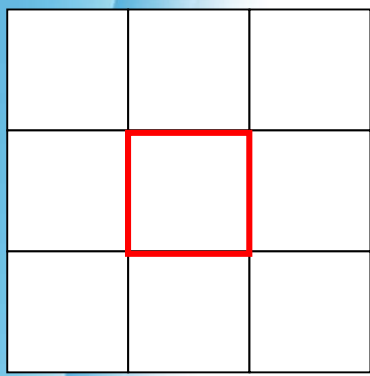

S_2

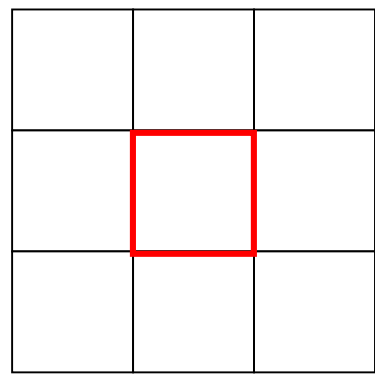

\otimes

P_1

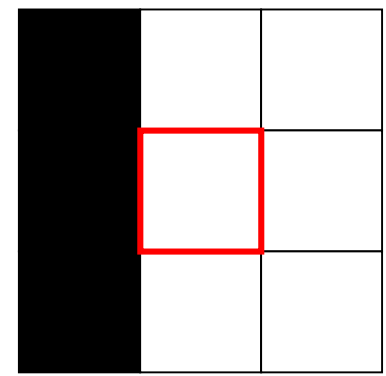

S_1

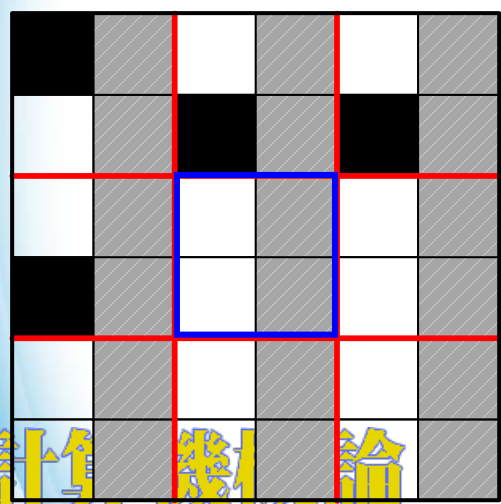

S_2

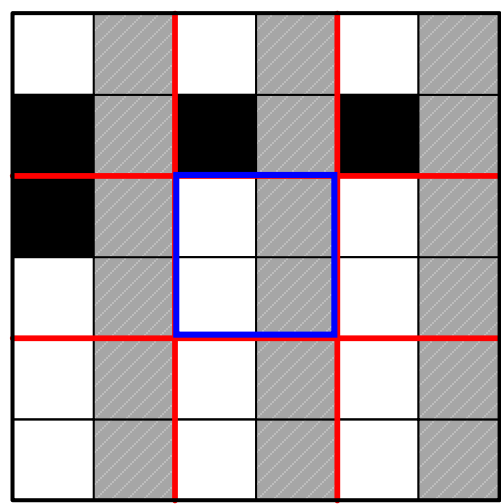

平移式視覺密碼

(Wu and Yang, 2001)

S_1

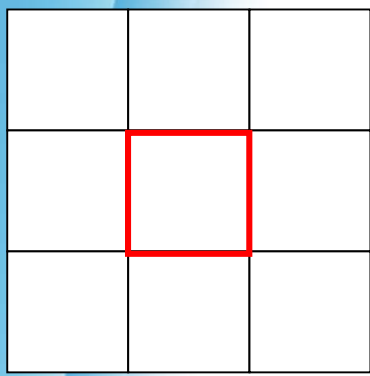

\otimes

S_2

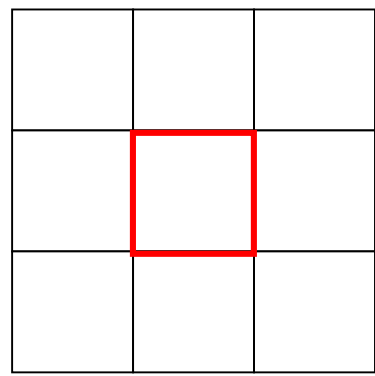

P_1

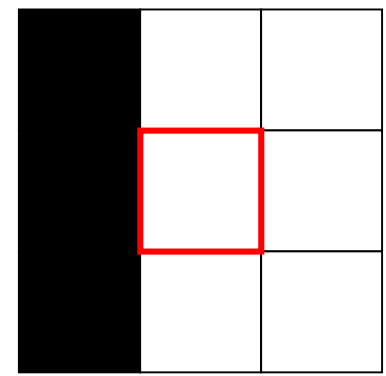

S_1

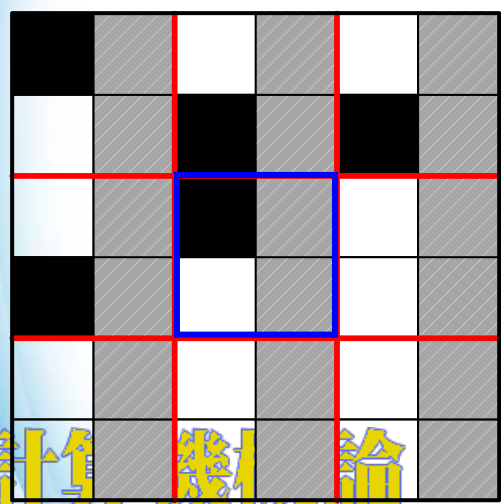

S_2

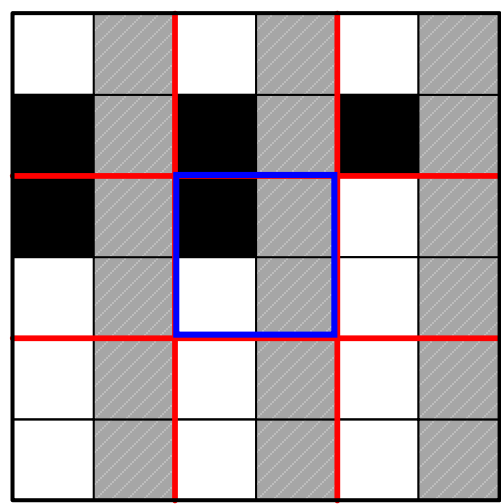

平移式視覺密碼

(Wu and Yang, 2001)

S_1

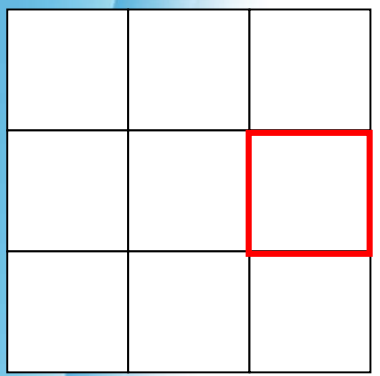

\otimes

S_2

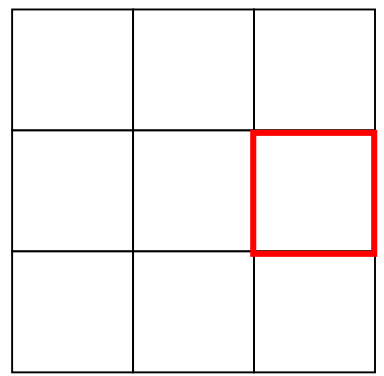

P_1

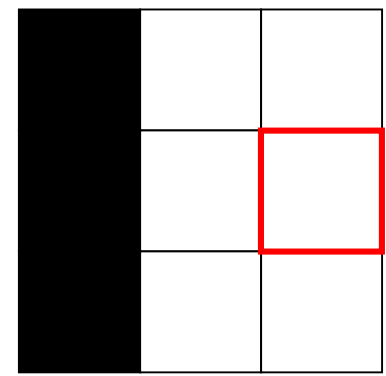

S_1

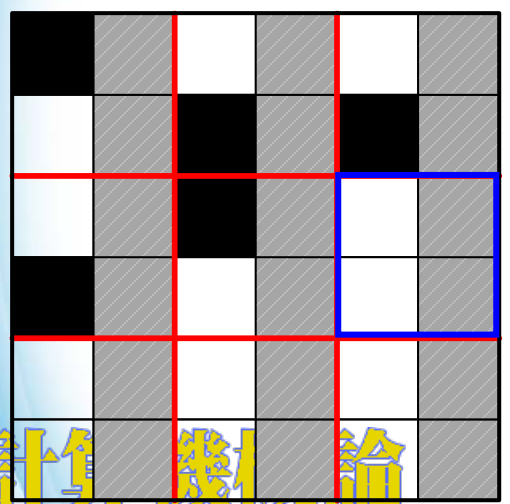

S_2

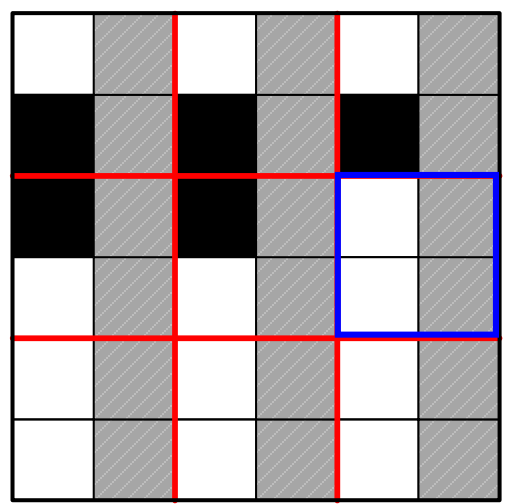

平移式視覺密碼

(Wu and Yang, 2001)

S_1

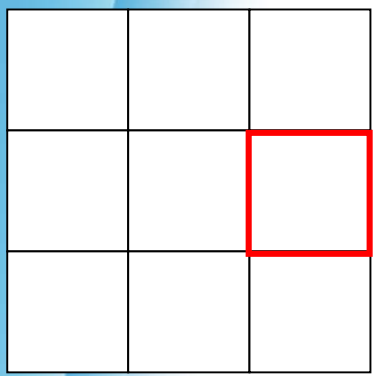

\otimes

S_2

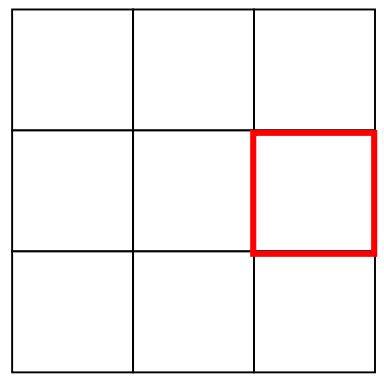

P_1

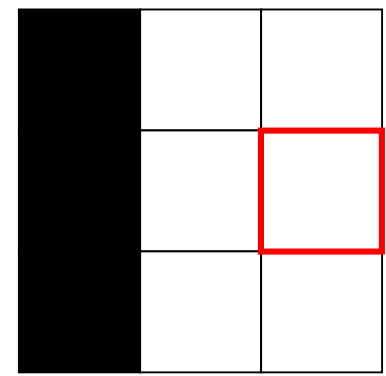

S_1

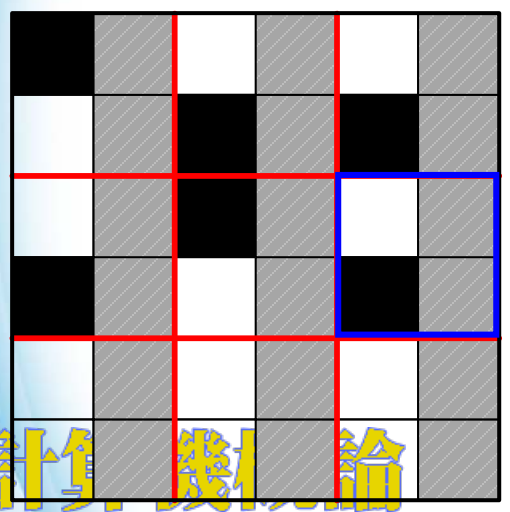

S_2

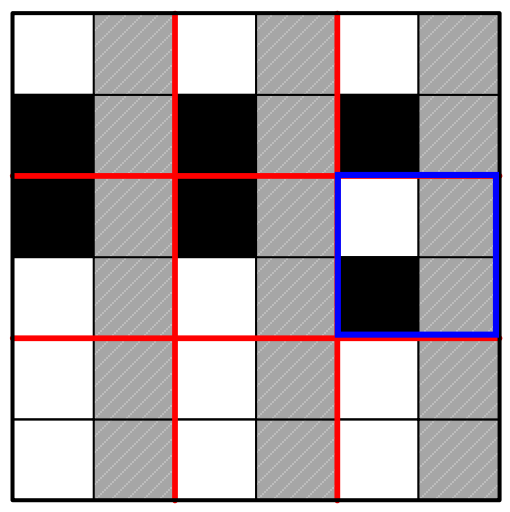

平移式視覺密碼

(Wu and Yang, 2001)

S_1

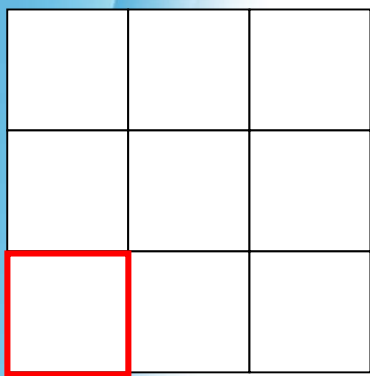

S_2

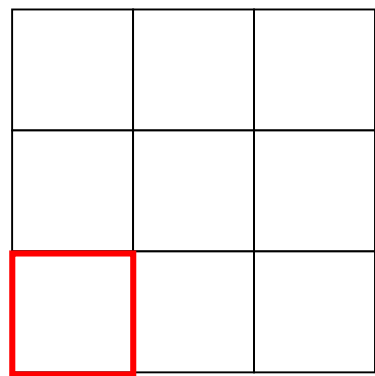

\otimes

P_1

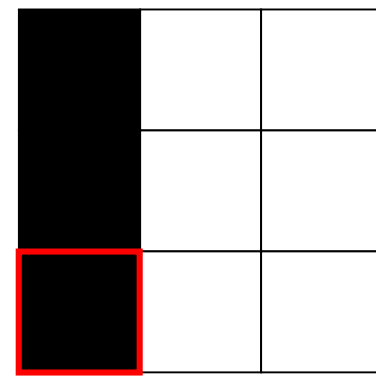

S_1

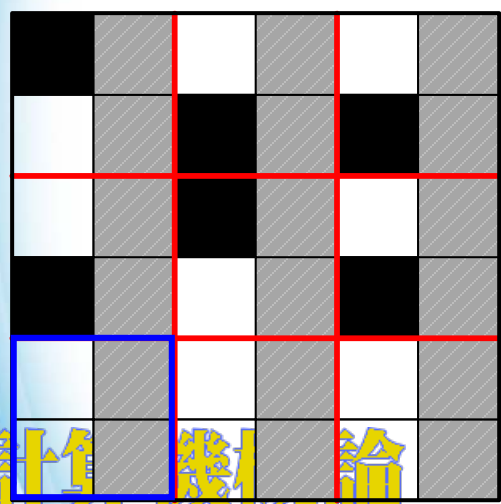

S_2

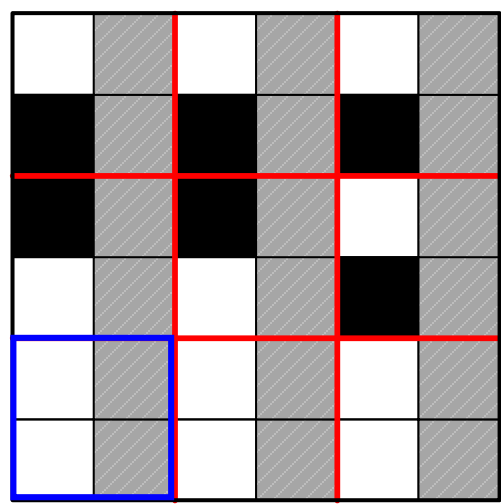

平移式視覺密碼

(Wu and Yang, 2001)

S_1

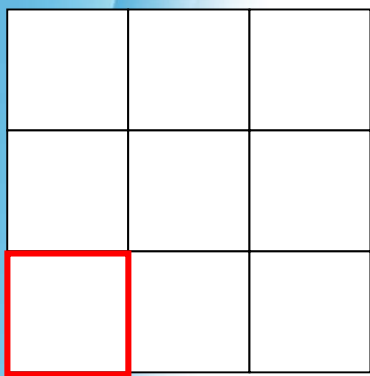

S_2

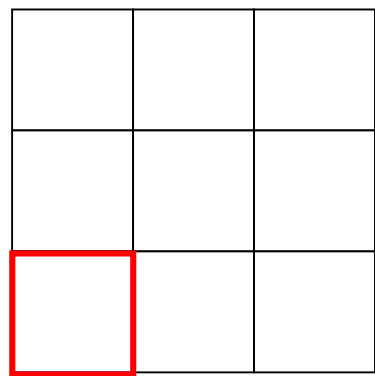

\otimes

P_1

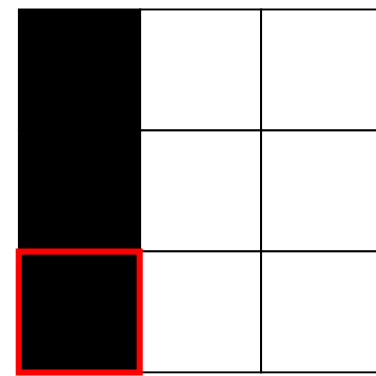

S_1

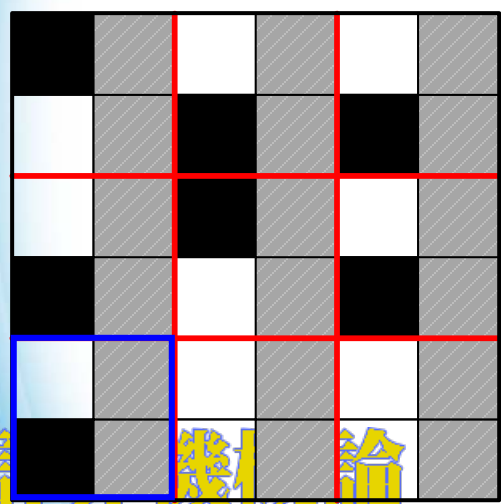

S_2

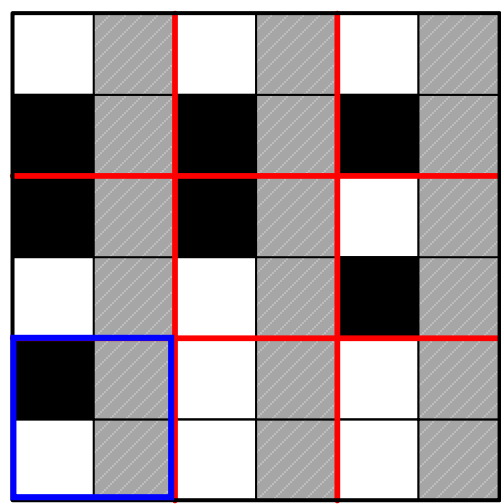

平移式視覺密碼

(Wu and Yang, 2001)

S_1

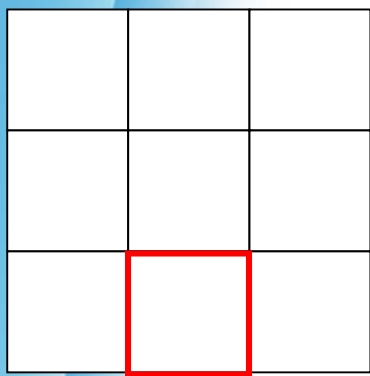

\otimes

S_2

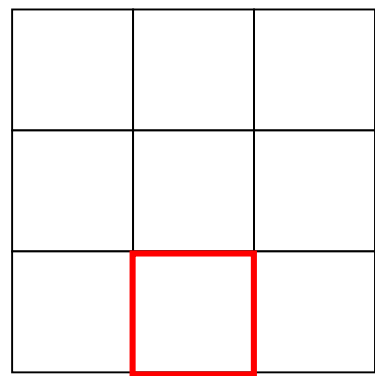

P_1

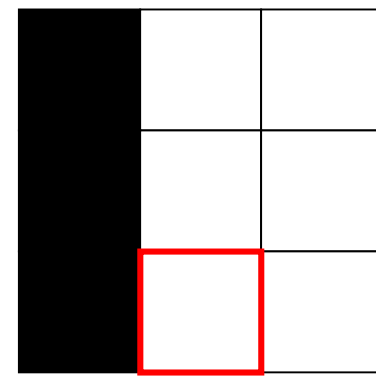

S_1

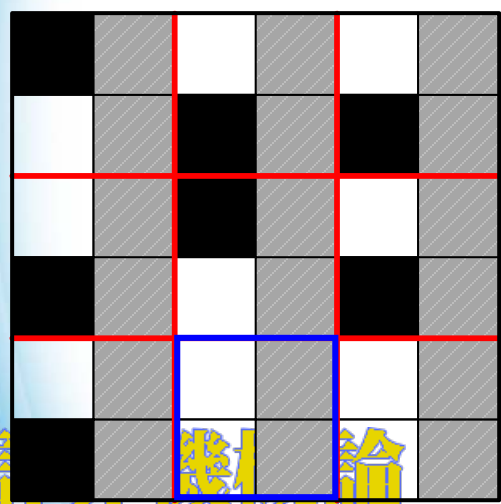

S_2

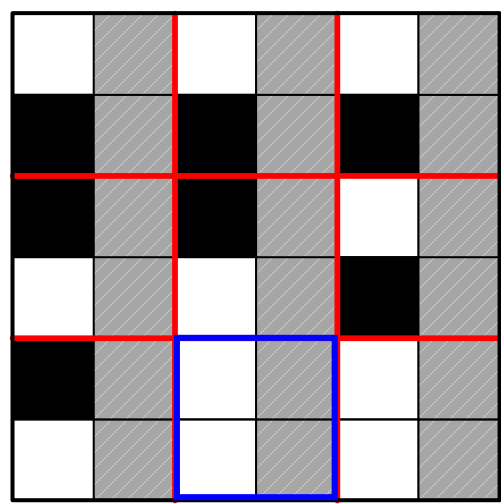

平移式視覺密碼

(Wu and Yang, 2001)

S_1

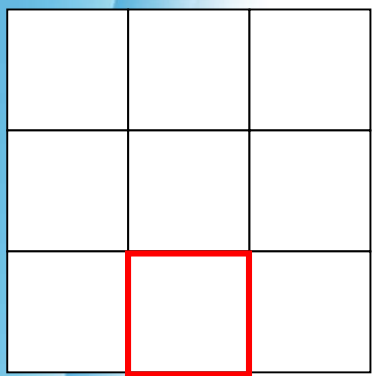

\otimes

S_2

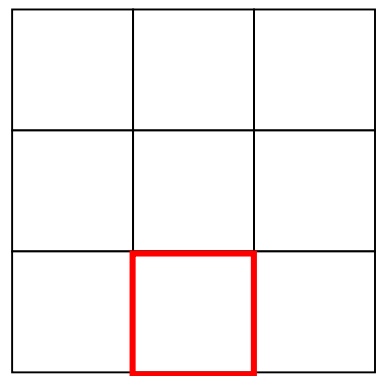

P_1

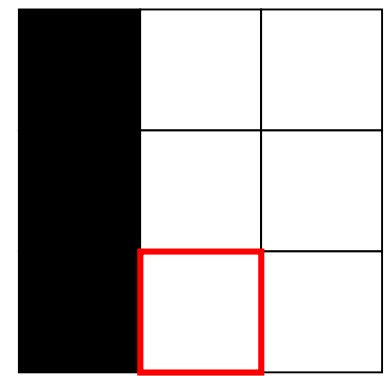

S_1

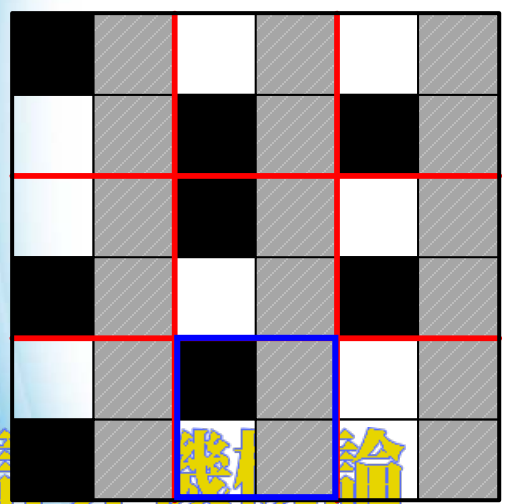

S_2

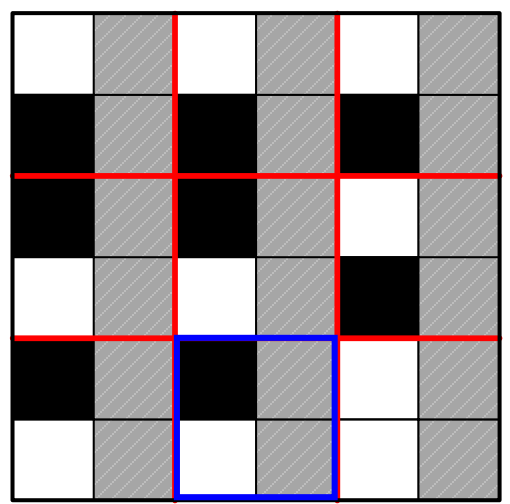

平移式視覺密碼

(Wu and Yang, 2001)

S_1

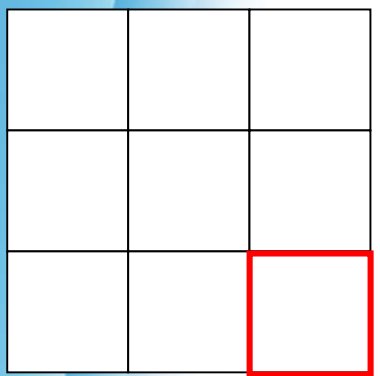

\otimes

S_2

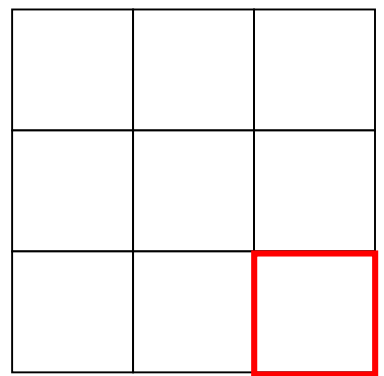

P_1

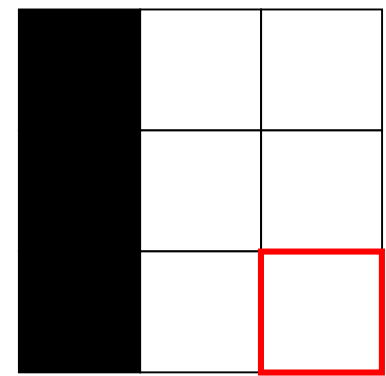

S_1

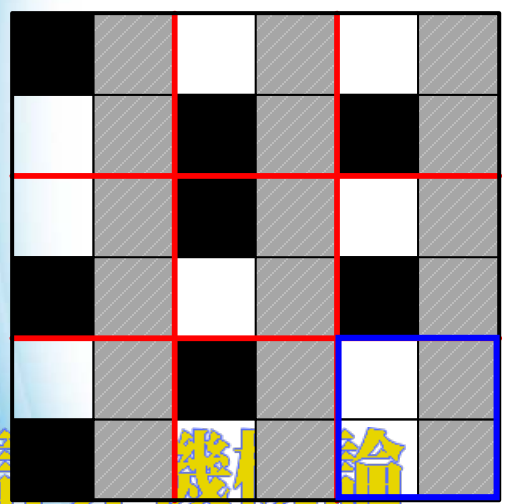

S_2

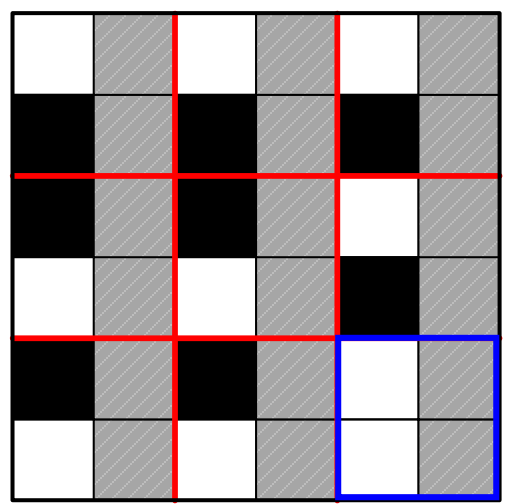

平移式視覺密碼

(Wu and Yang, 2001)

S_1

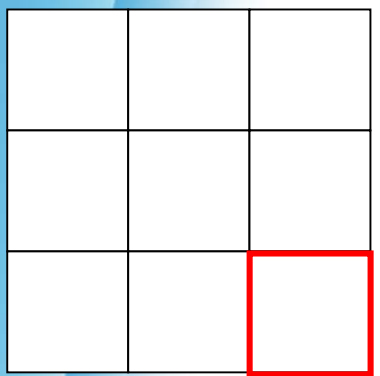

\otimes

S_2

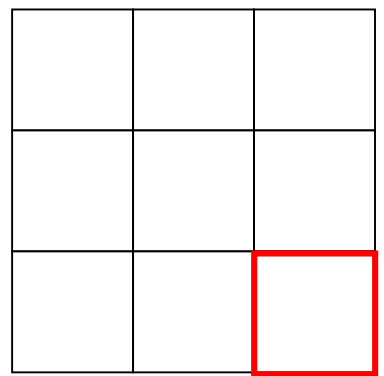

P_1

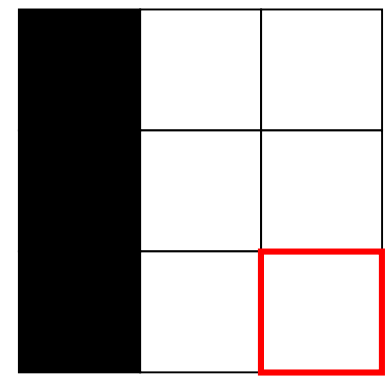

S_1

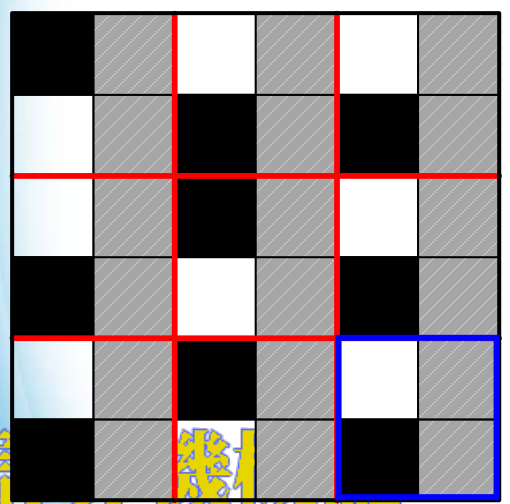

S_2

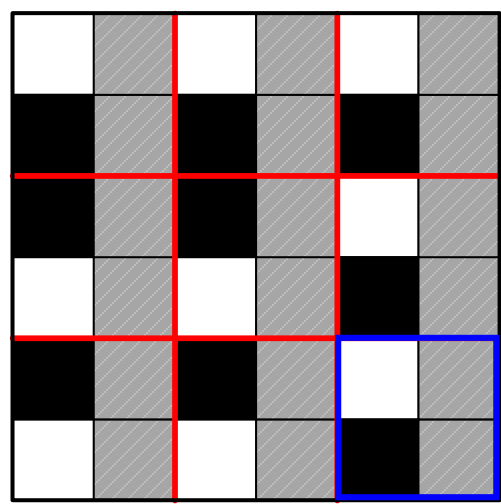

平移式視覺密碼

(Wu and Yang, 2001)

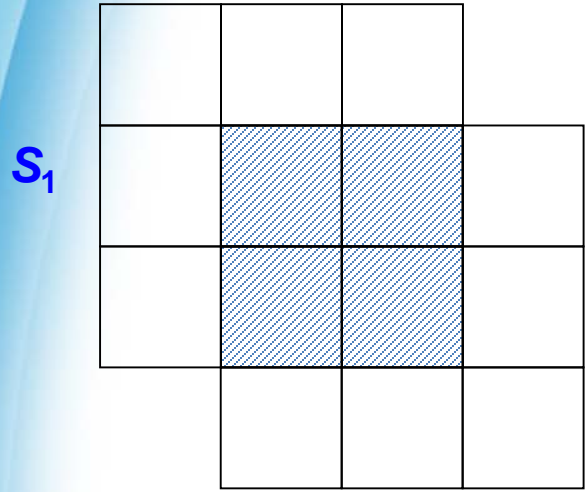

S_2

P_2

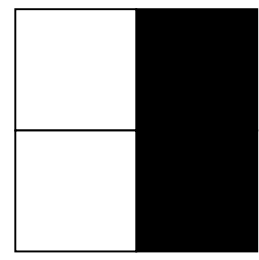

S_1

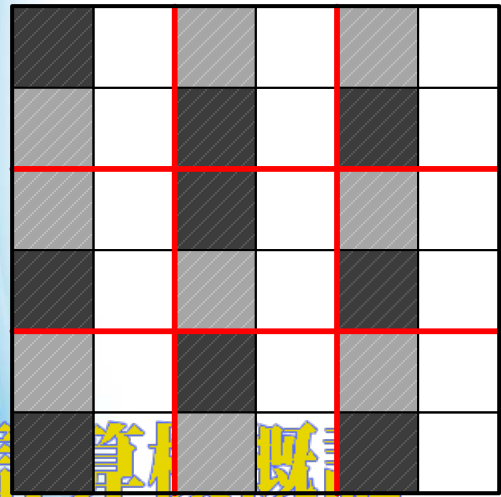

S_2

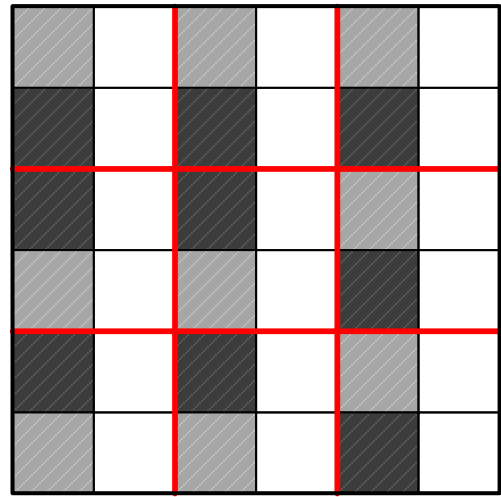

平移式視覺密碼

(Wu and Yang, 2001)

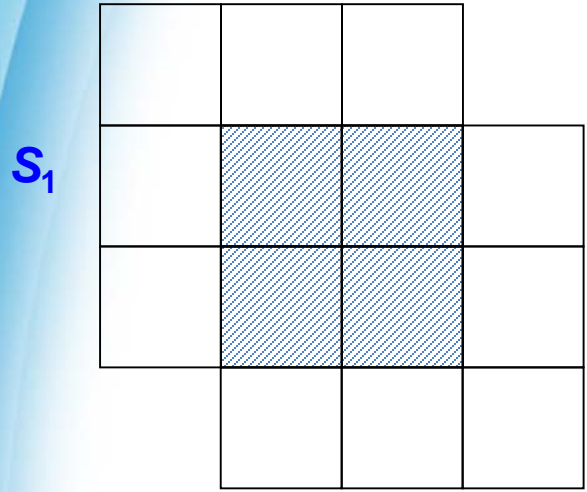

S_2

P_2

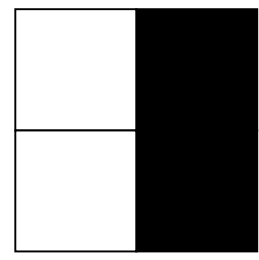

S_1

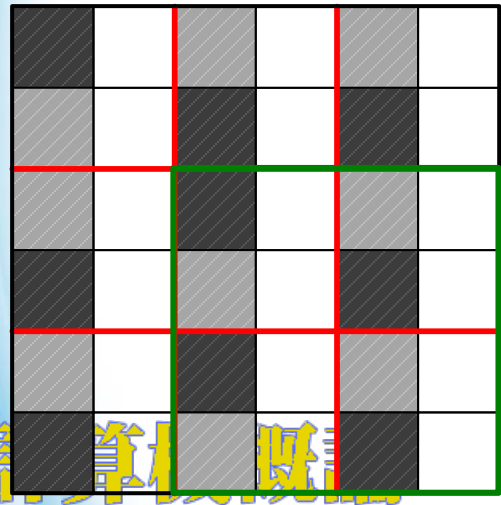

S_2

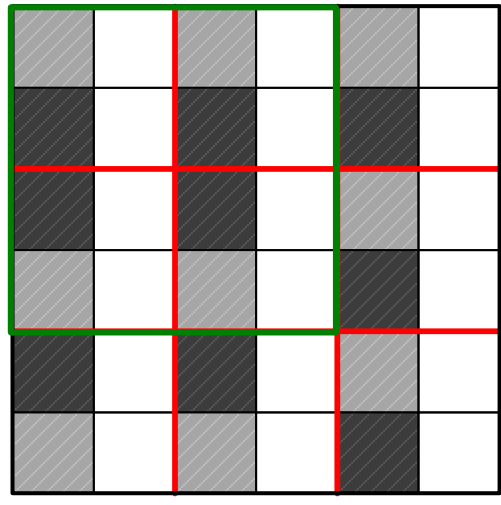

平移式視覺密碼

(Wu and Yang, 2001)

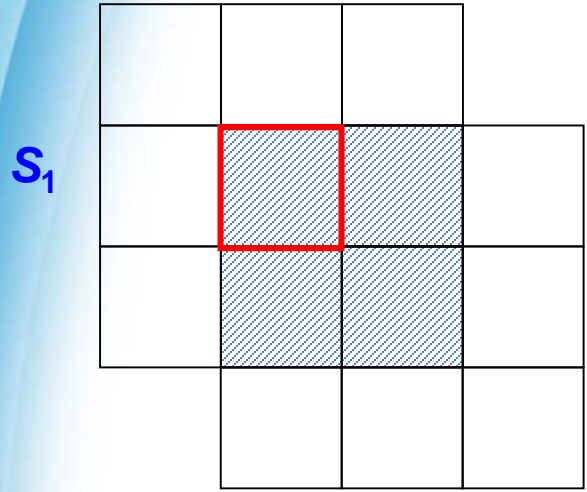

S_2

P_2

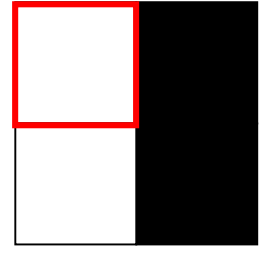

S_1

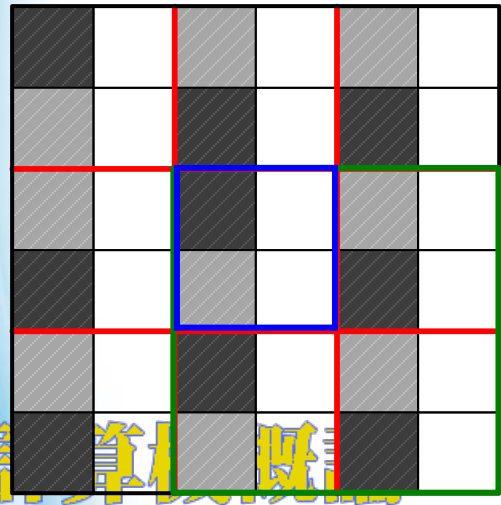

S_2

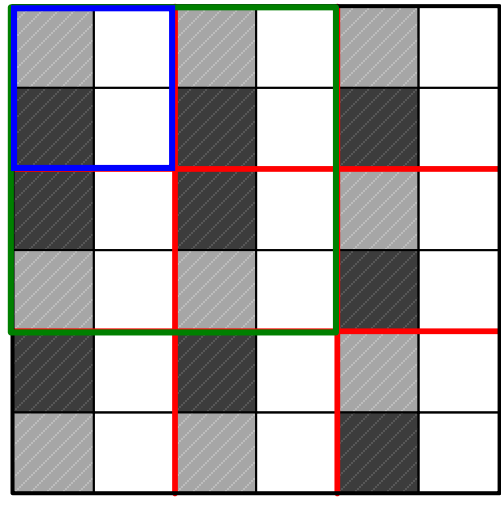

平移式視覺密碼

(Wu and Yang, 2001)

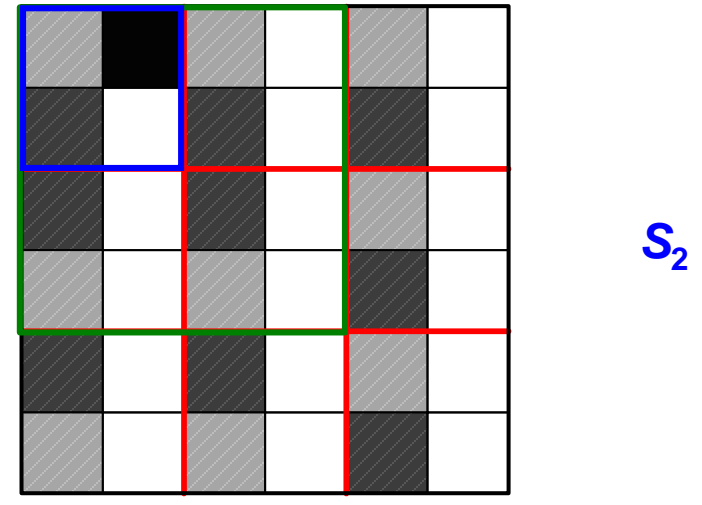
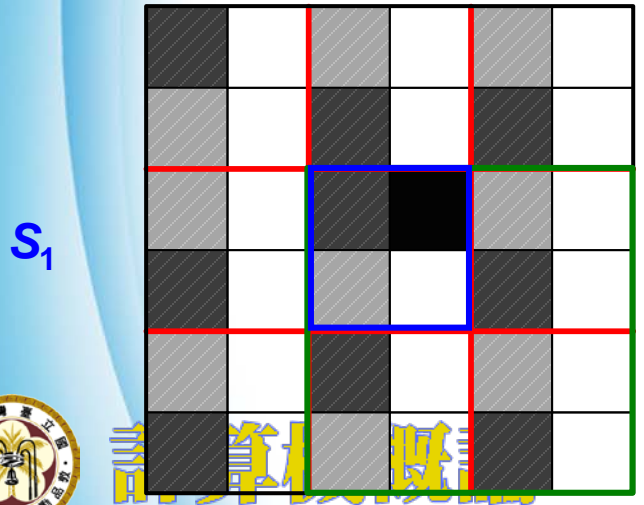
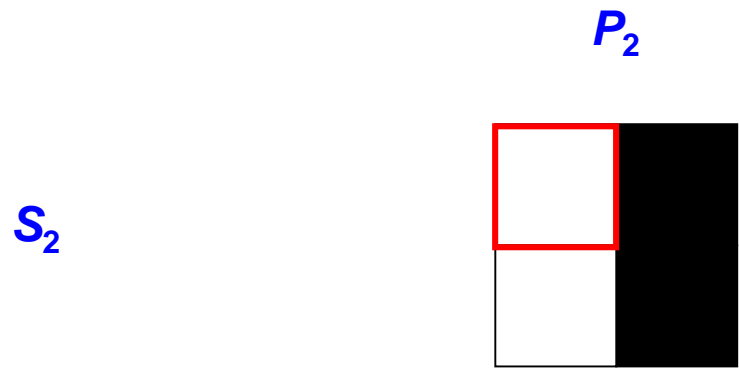
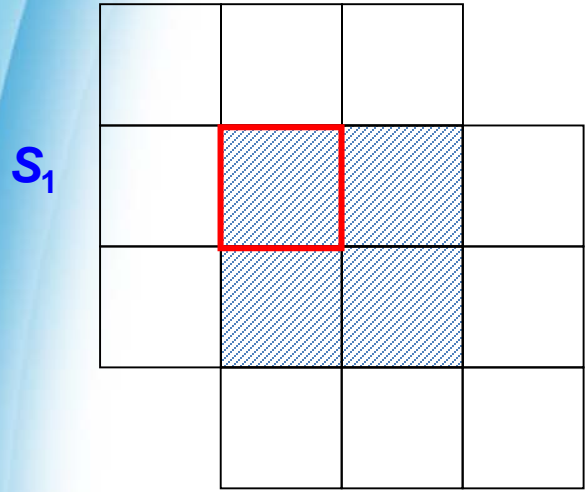

平移式視覺密碼

(Wu and Yang, 2001)

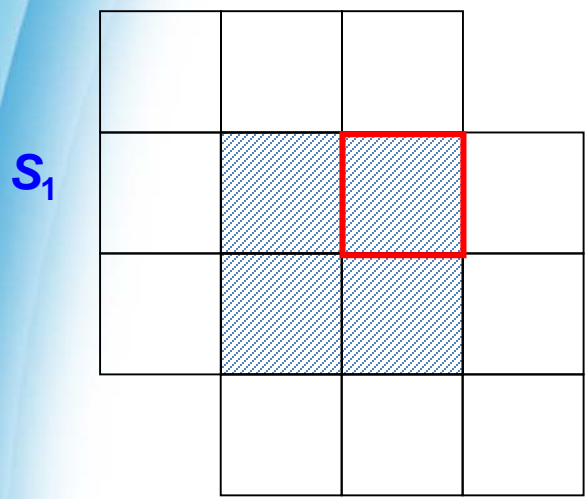

S_2

P_2

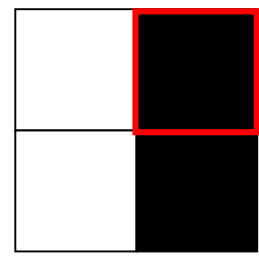

S_1

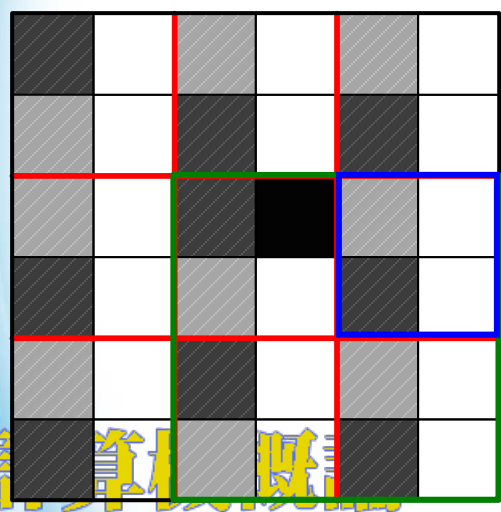

S_2

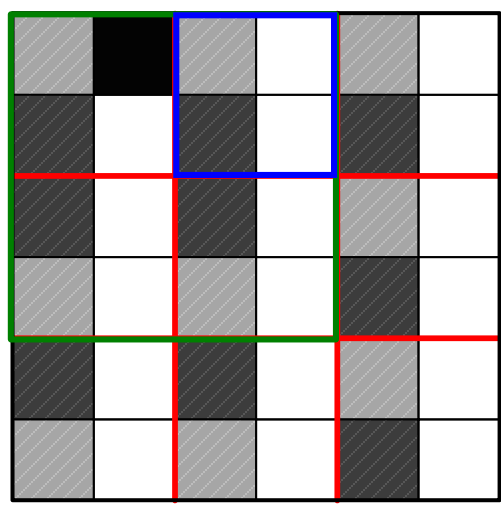

平移式視覺密碼

(Wu and Yang, 2001)

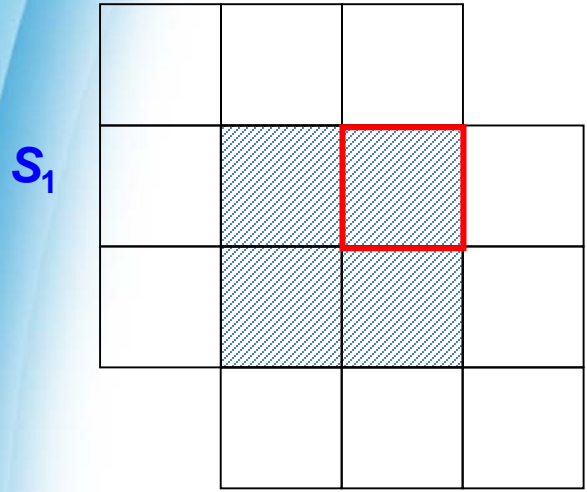

S_2

P_2

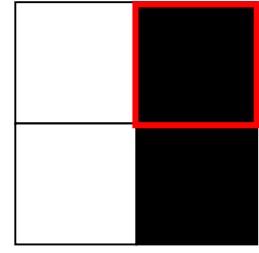

S_1

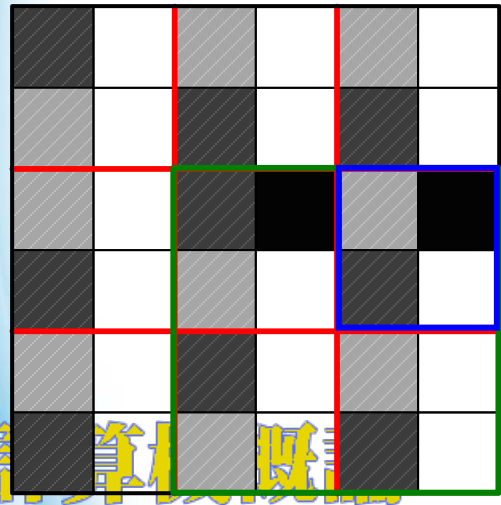

S_2

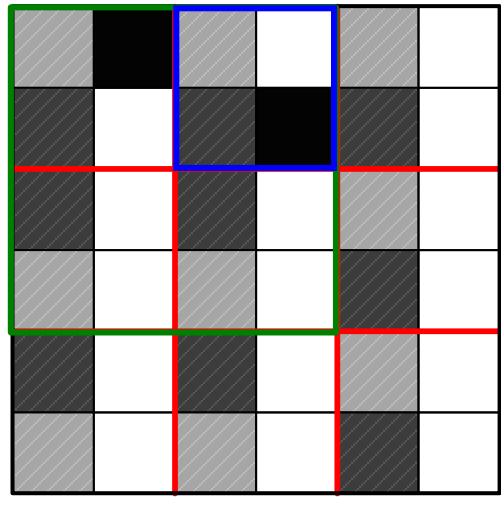

平移式視覺密碼

(Wu and Yang, 2001)

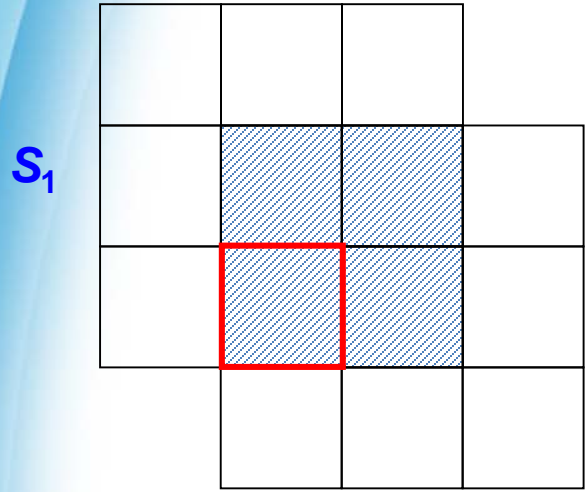

S_2

P_2

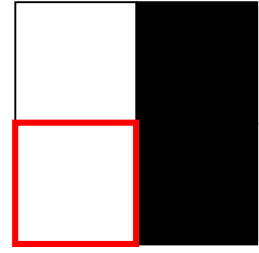

S_1

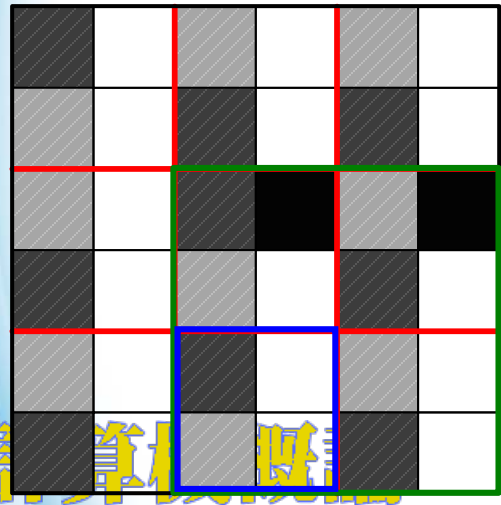

S_2

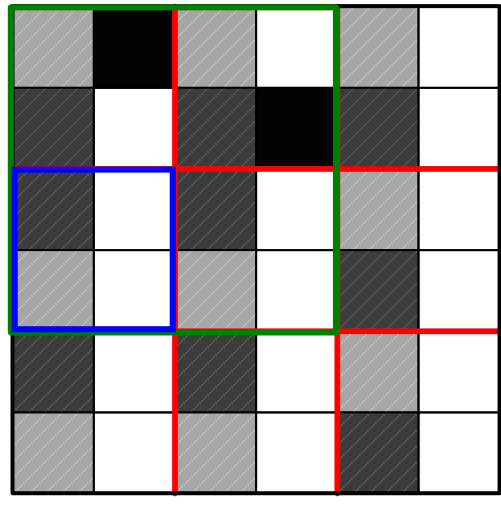

平移式視覺密碼

(Wu and Yang, 2001)

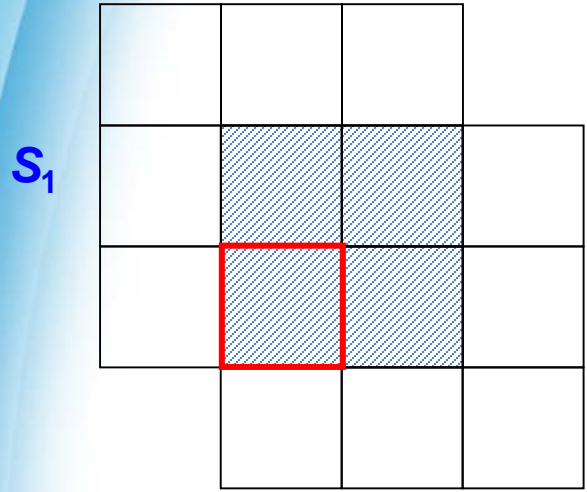

S_2

P_2

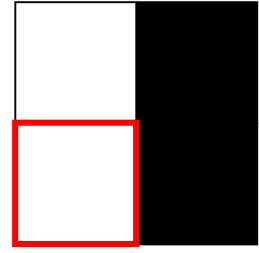

S_1

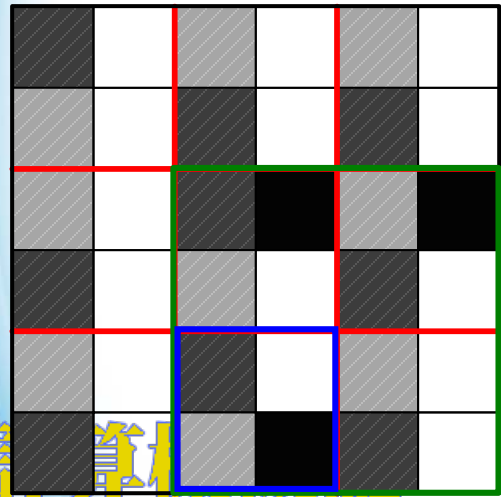

S_2

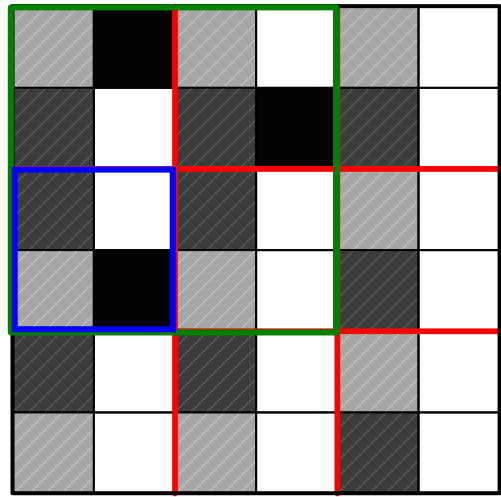

平移式視覺密碼

(Wu and Yang, 2001)

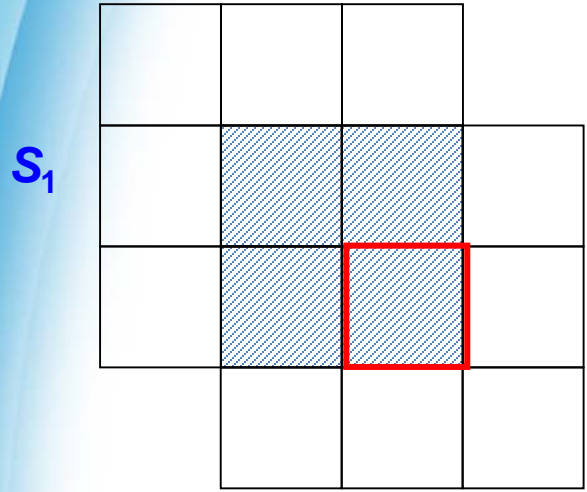

S_2

P_2

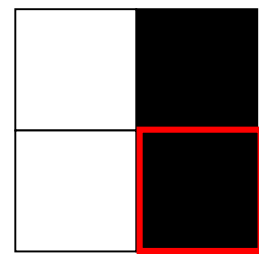

S_1

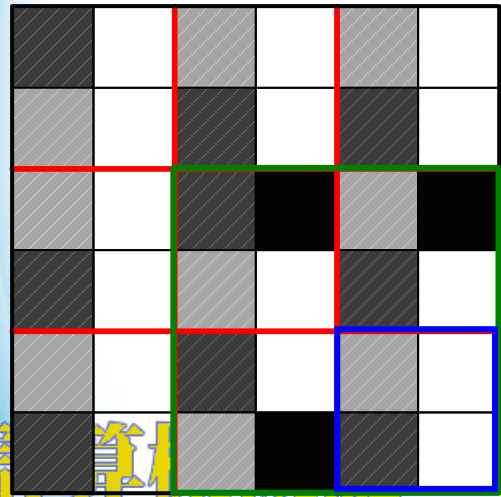

S_2

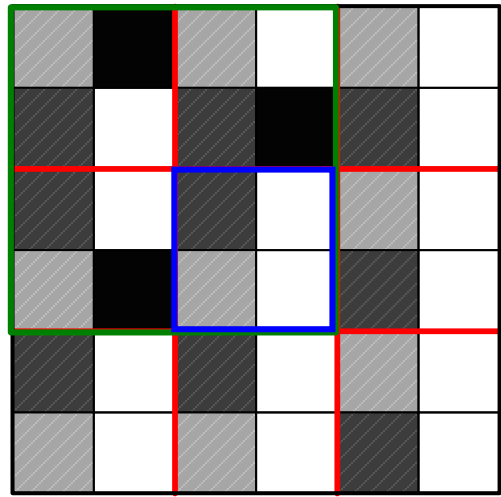

平移式視覺密碼

(Wu and Yang, 2001)

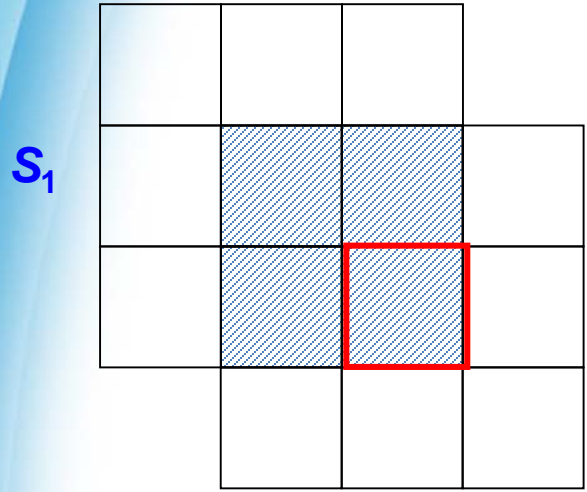

S_2

P_2

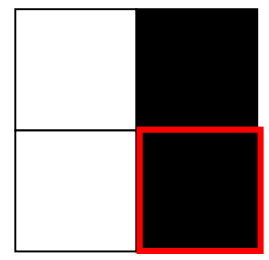

S_1

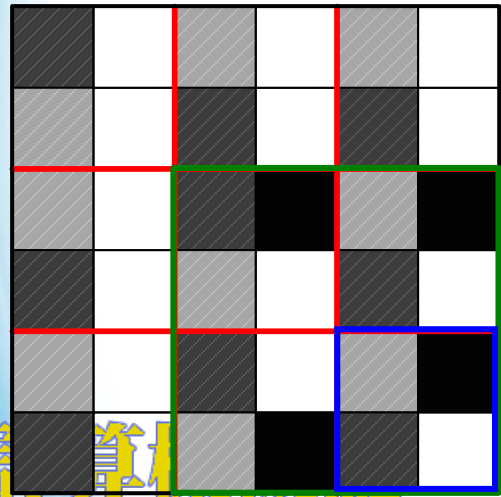

S_2

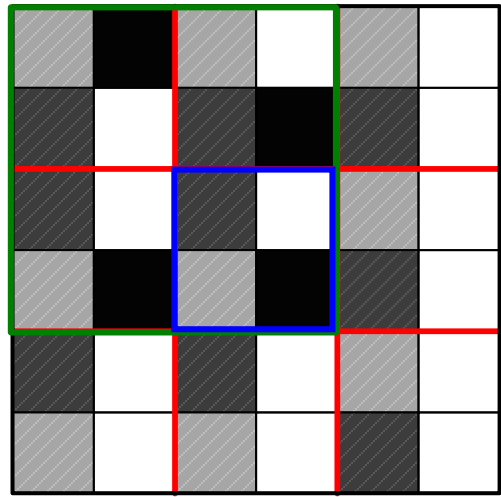

平移式視覺密碼

(Wu and Yang, 2001)

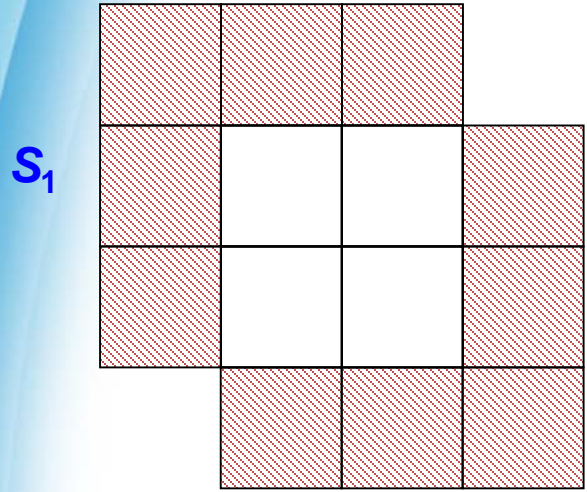

S_2

P_2

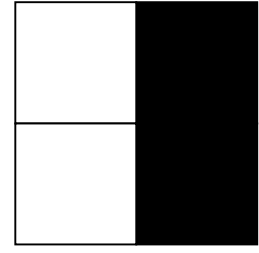

S_1

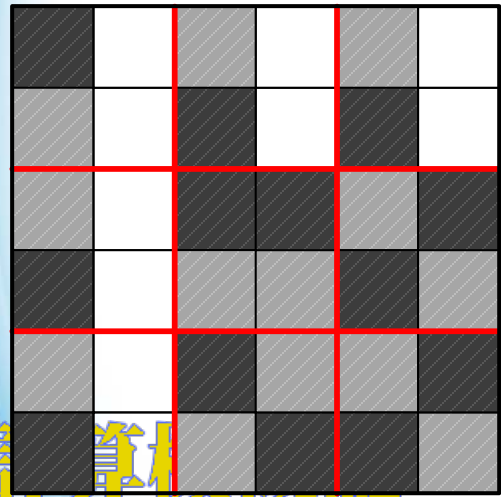

S_2

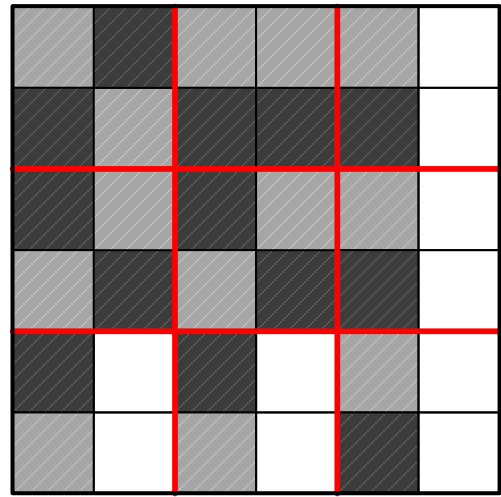

平移式視覺密碼

(Wu and Yang, 2001)

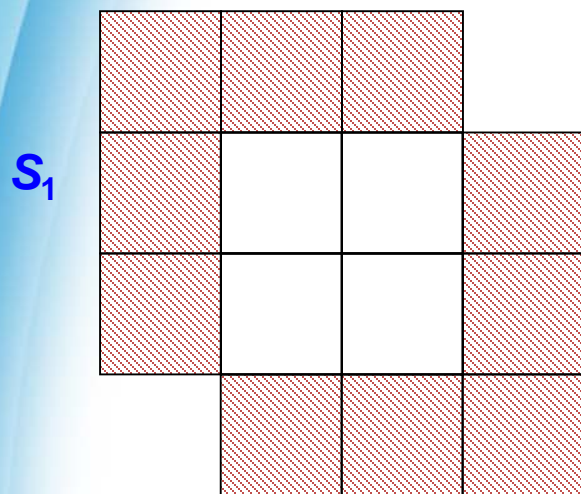

S_2

P_2

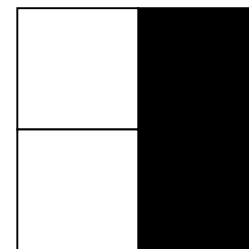

S_1

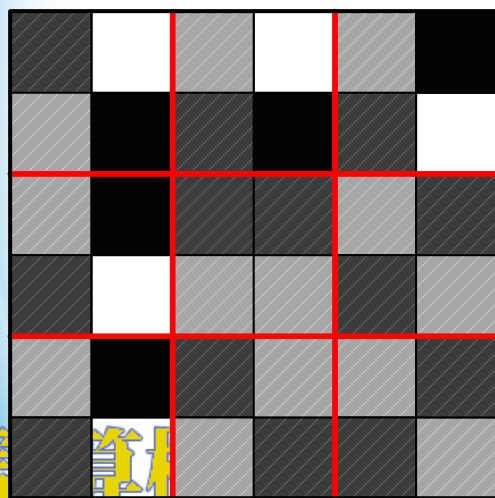

S_2

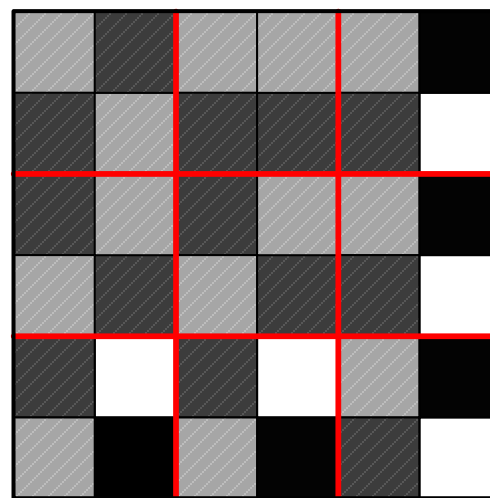

平移式視覺密碼

(Wu and Yang, 2001)

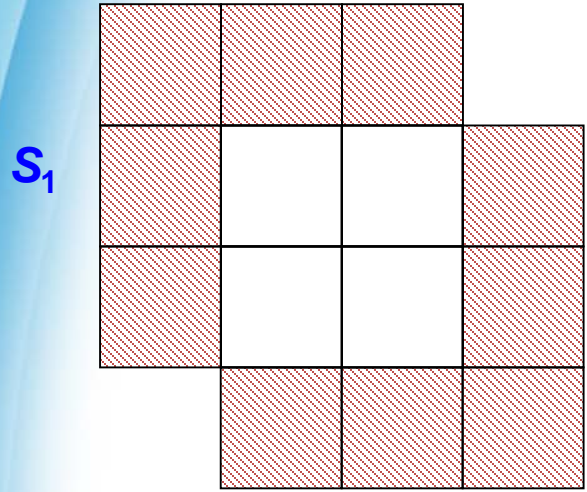

S_2

P_2

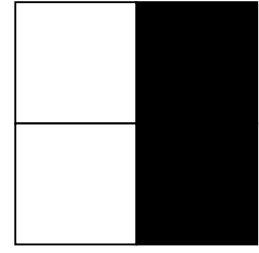

S_1

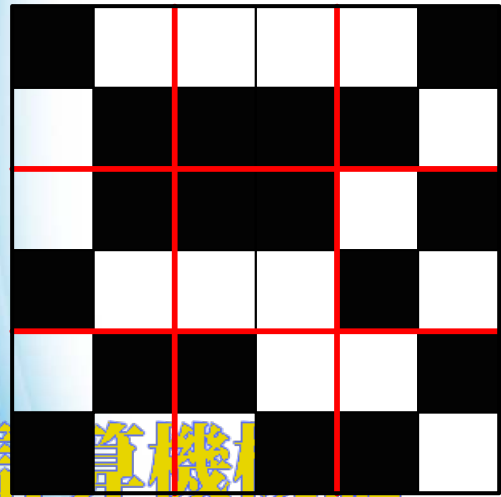

S_2

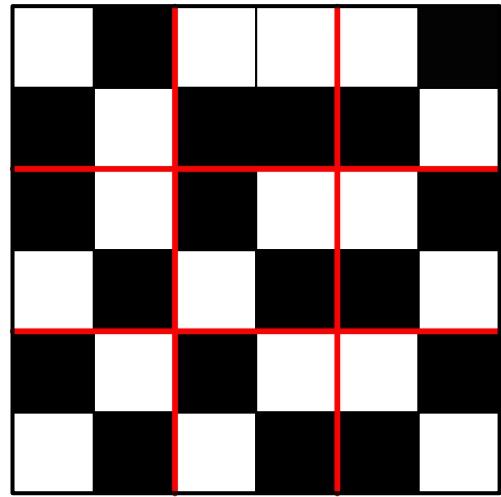

平移式視覺密碼

(Wu and Yang, 2001)

S_1

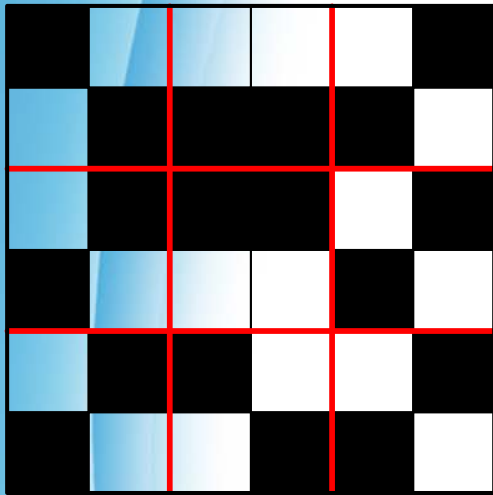

S_2

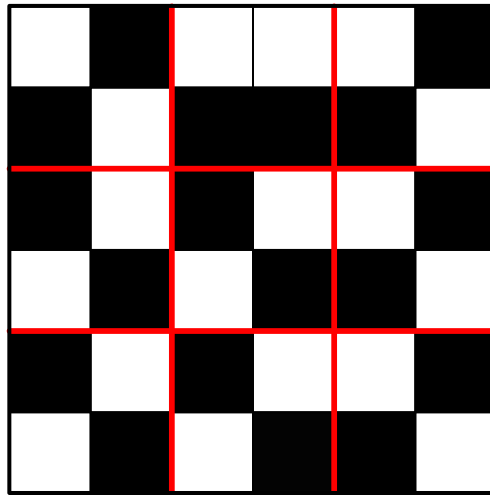

P_1

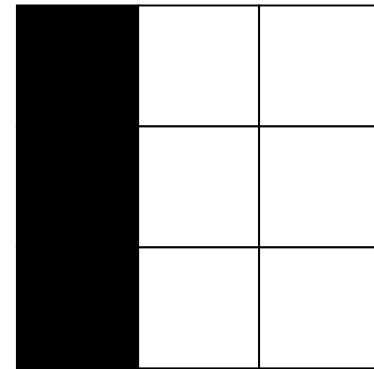

P_2

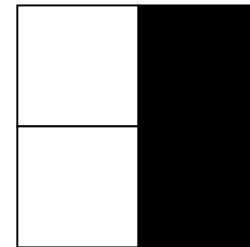

平移式視覺密碼

(Wu and Yang, 2001)

S_1

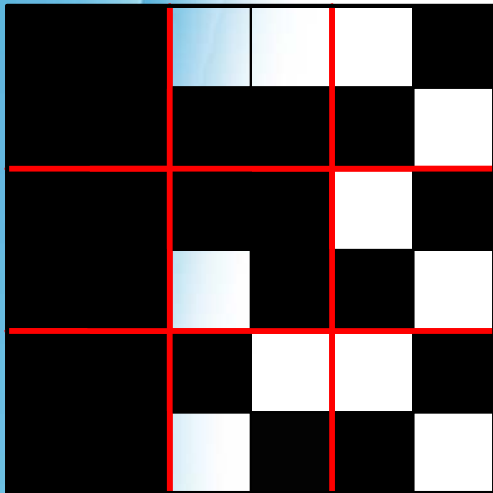

S_2

P_1

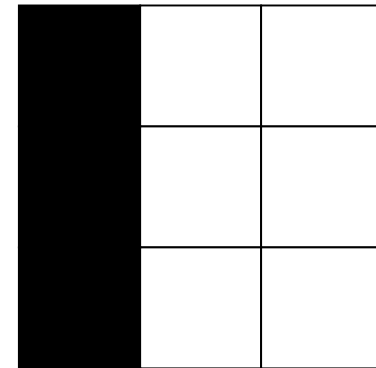

P_2

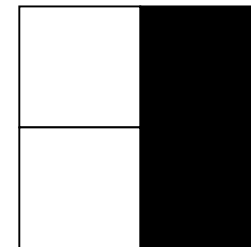

平移式視覺密碼

(Wu and Yang, 2001)

S_1

S_2

P_1

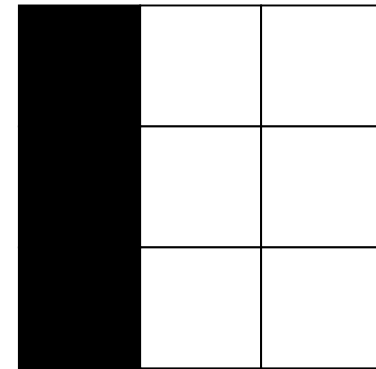
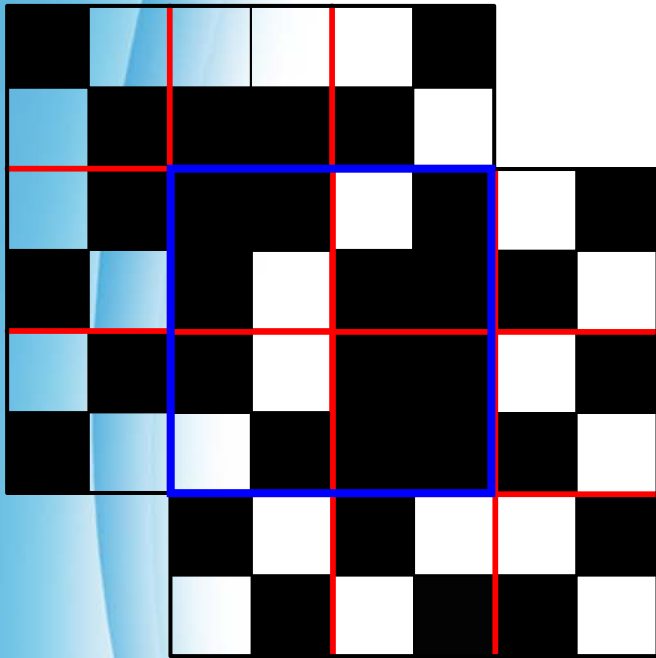

P_2

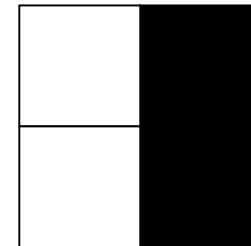

Related Work

	Shadow shape	Number of secrets	Operator	Pixel expansion	Contrast
Wu & Chen (1998)	square	2	rotation (90°)	4	1/4
Wu, Chang (2005)	circular	2	rotation (θ)	4	1/4, 1/2
Shyu et. al. (2007)	circular	$x \geq 2$	rotation ($\theta=360^\circ/x$)	$2x$	$1/2x$, 1/2
Feng et. al. (2008)	cylinder	$x \geq 2$	rotation ($\theta=360^\circ/x$)	$3x$	$1/3x$, $1/3x$
Chen et. al. (2009)	cylinder	4	rotation & flipping	9	2/9
Shyu & Chen (2010)	circular & cylinder	$x \geq 2$	rotation (any θ)	1	$1/2^x$
Wu et. al. (2006)	rectangle	2	flipping	8	color
Shyu & Chen (2010)	square	2, 4, 8	flipping	4, 9, 16 ($2x$)	1/4, 1/9, 1/16



Related Work

	Shadow shape	Number of secrets	Operator	Pixel expansion	Contrast
Wu & Chen (1998)	square	2	rotation (90°)	4	1/4
Wu, Chang (2005)	circular	2	rotation (θ)	4	1/4, 1/2
Shyu et. al. (2007)	circular	$x \geq 2$	S_1	2	1/2
Feng et. al. (2008)	cylinder	$x \geq 2$	3	3	1/3x
Chen et. al. (2009)	cylinder	4	rotation &	0	2/9
Shyu & Chen (2010)	circular & cylinder	$x \geq 2$	S_2	2	2x
Wu et. al. (2006)	rectangle	2			or
Shyu & Chen (2010)	square	2, 4, 8		4, 9, 16	1/9, 1/16

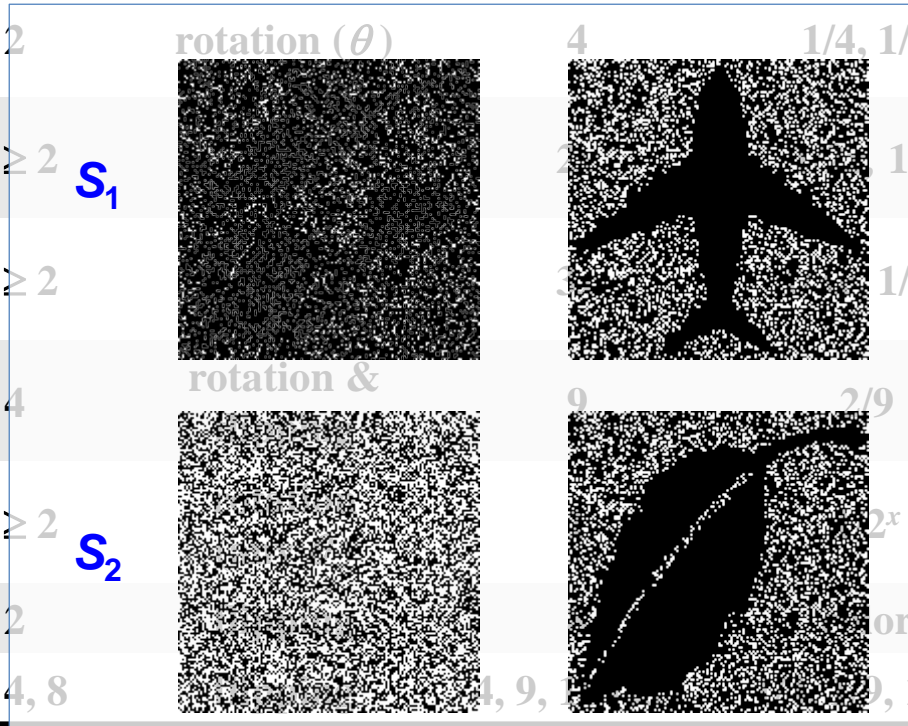

Related Work

	Shadow shape	Number of secrets	Operator	Pixel expansion	Contrast
Wu & Chen (1998)	square	2	rotation (90°)	4	1/4
Wu, Chang (2005)	circular	2	rotation (θ)	4	1/4, 1/2
Shyu et al. (2009)	circular	$x \geq 2$	rotation (θ)	x	1/2
Shyu et al. (2010)	circular	≥ 2	rotation	1	1/2 ^x
Shyu et al. (2010)	circular	2	flipping	4	1/4
Shyu et al. (2010)	circular	2, 4	flipping	4, 16	1/4, 1/16

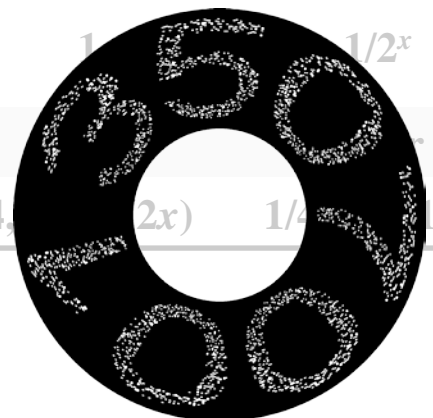
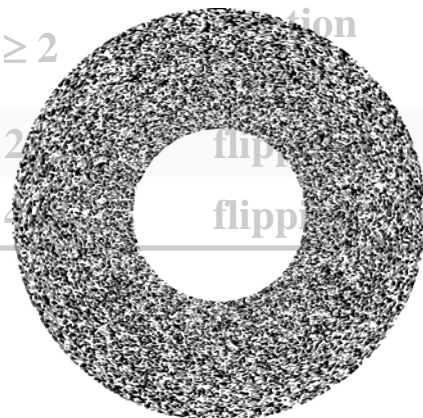
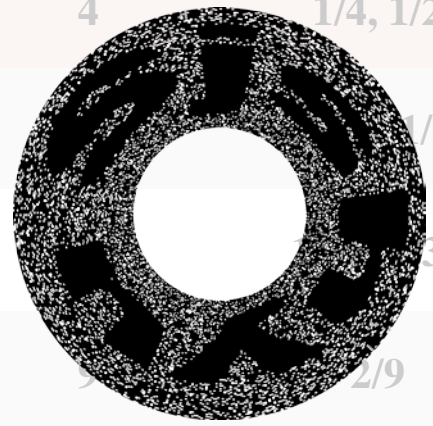
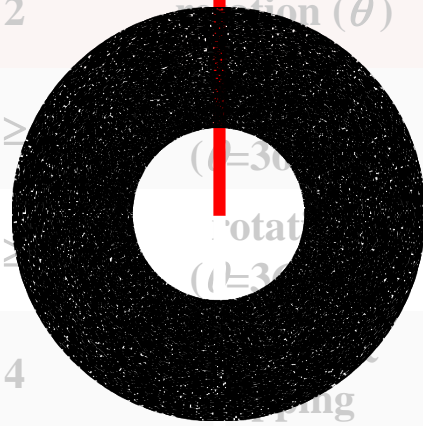

Related Work

	Shadow shape	Number of secrets	Operator	Pixel expansion	Contrast
Wu & Chen (1998)	square	2	rotation (90°)	4	1/4
Wu, Chang (2005)	circular	2	rotation (θ)	4	1/4, 1/2
Shyu et. al. (2007)	circular	$x \geq 2$	rotation ($\theta=360^\circ/x$)	$2x$	$1/2x, 1/2$

Feng et. al.

Chen et. al.

Shyu & Chen

Wu et. al.

Shyu & Chen

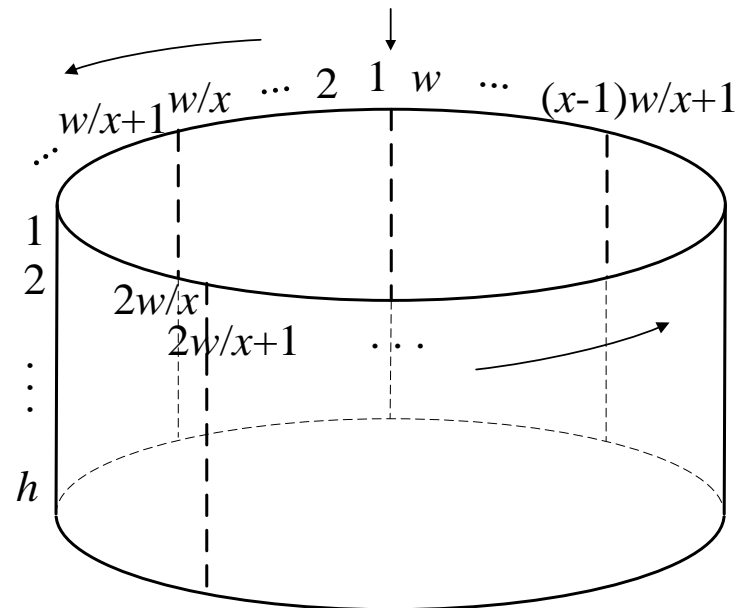
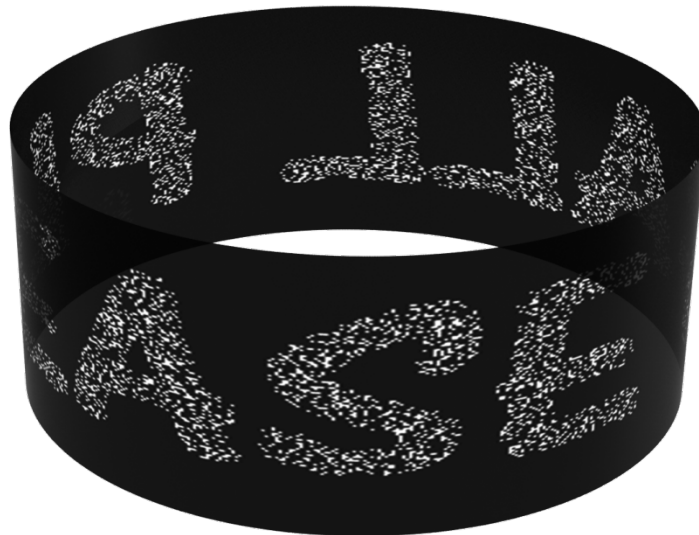

計

Related Work

	Shadow shape	Number of secrets	Operator	Pixel expansion	Contrast
Wu & Chen (1998)	square	2	rotation (90°)	4	1/4
Wu, Chang (2005)	circular	2	rotation (θ)	4	1/4, 1/2
Shyu et. al. (2007)	circular	$x \geq 2$	rotation ($\theta=360^\circ/x$)	$2x$	$1/2x, 1/2$
Feng et. al. (2008)	cylinder	$x \geq 2$	rotation ($\theta=360^\circ/x$)	$3x$	$1/3x, 1/3x$
Chen et. al. (2009)	cylinder	4	rotation & flipping	9	2/9
Shyu & Chen (2010)	circular	$x \geq 2$	rotation	1	$1/2^x$
Wu et. al. (2006)	recta	2		8	color
Shyu & Chen (2010)	sq	4, 8		1, 9, 16	1/9, 1/16

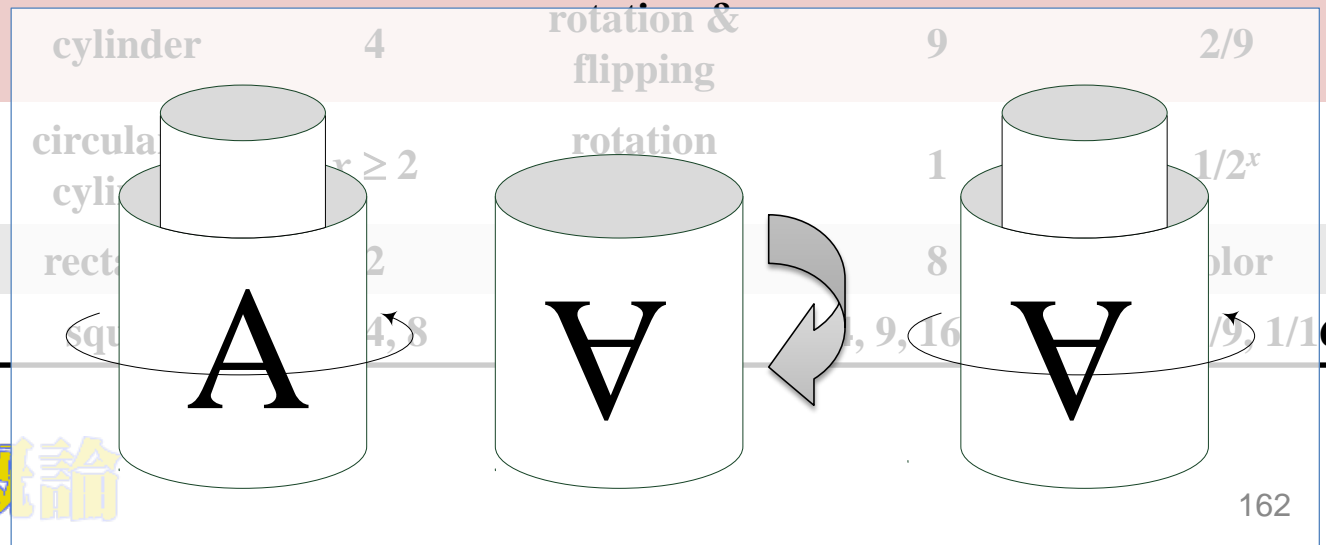

Related Work



		Number of secrets	Operator	Pixel expansion	Contrast
		2	rotation (90°)	4	1/4
		2	rotation (θ)	4	1/4, 1/2
		$x \geq 2$	rotation ($\theta=360^\circ/x$)	$2x$	$1/2x$, 1/2
		$x \geq 2$	rotation ($\theta=360^\circ/x$)	$3x$	$1/3x$, $1/3x$
Chen et. al. (2009)	cylinder	4	rotation & flipping	9	2/9
Shyu & Chen (2010)	circular & cylinder	$x \geq 2$	rotation (any θ)	1	$1/2^x$
Wu et. al. (2006)	rectangle	2	flipping	8	color
Shyu & Chen (2010)	square	2, 4, 8	flipping	4, 9, 16 ($2x$)	1/4, 1/9, 1/16



(2,3,3) Visual Cryptography

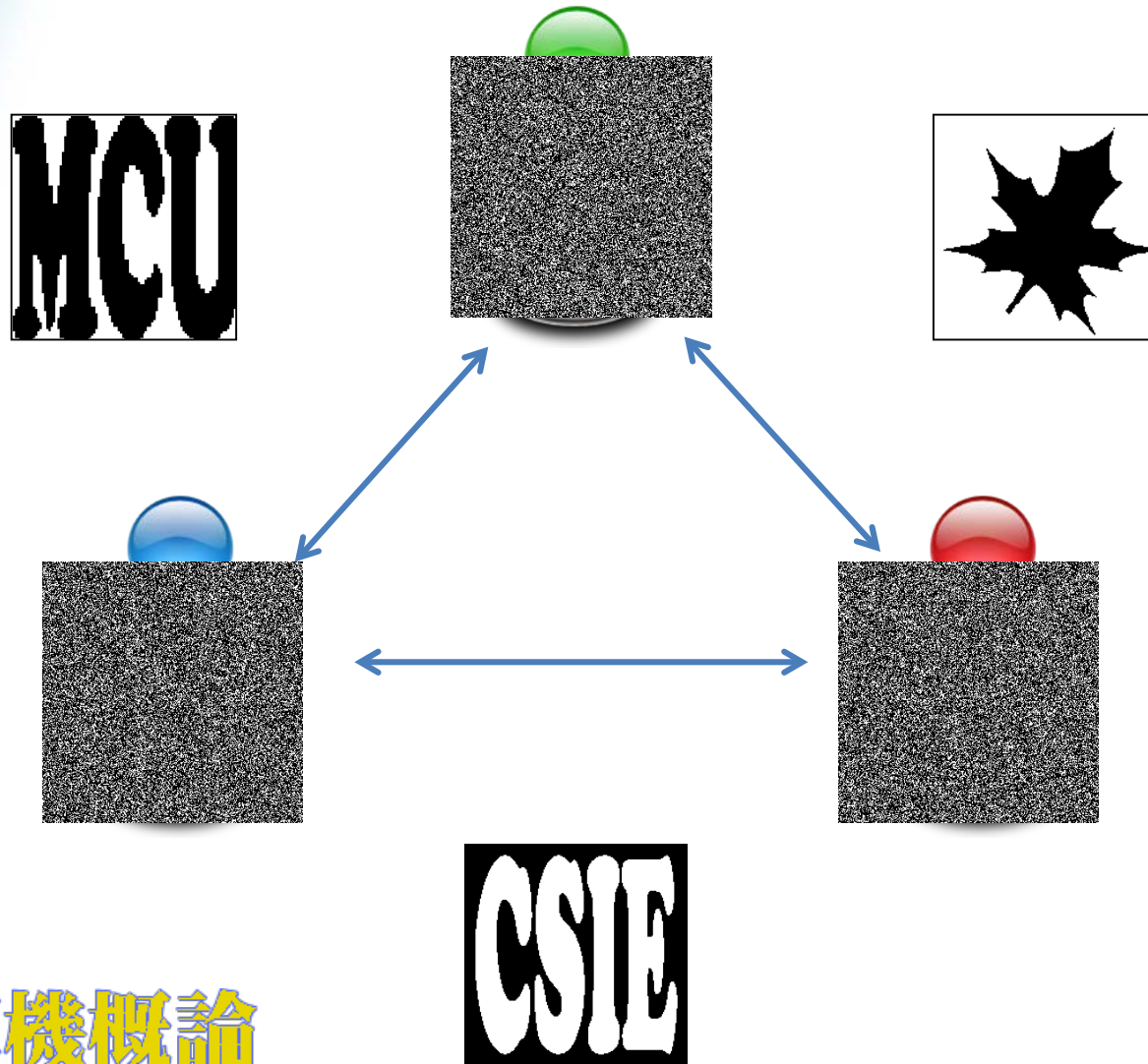

(2,3,3) Visual Cryptography



S_1



S_2



S_3

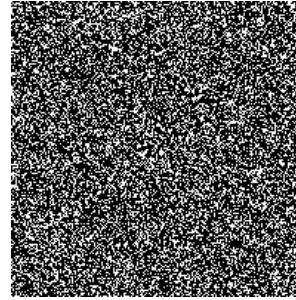
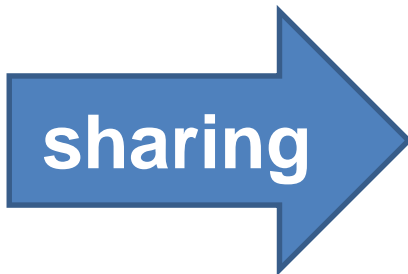

R_1

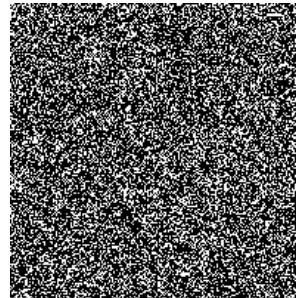

R_2

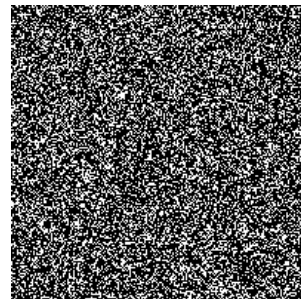

R_3



$R_1 \otimes R_2$



$R_2 \otimes R_3$

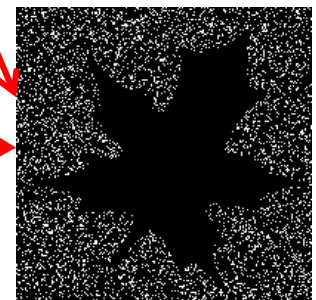

$R_3 \otimes R_1$



Extended VC

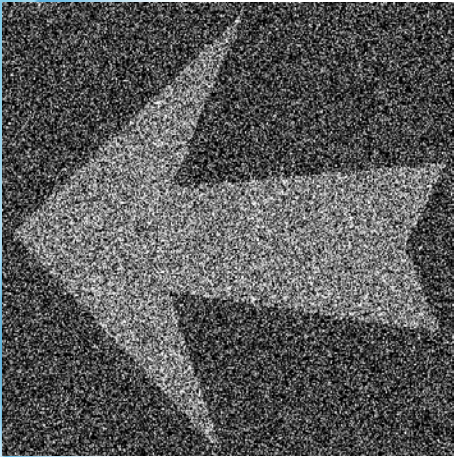

Share A

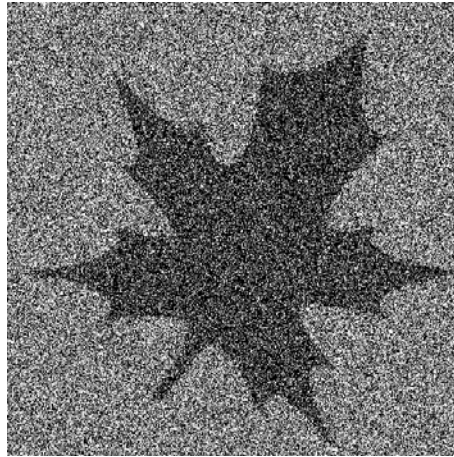

Share B

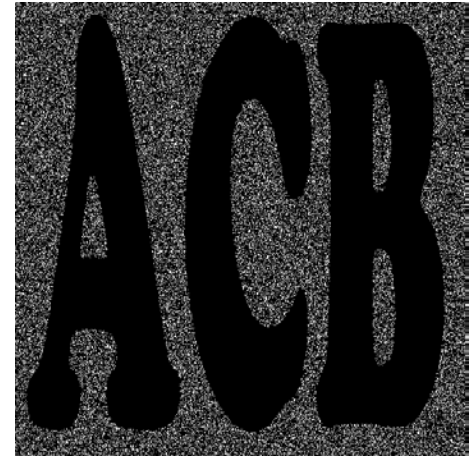

$A \otimes B$



視覺密碼與QR-Code (1)



視覺密碼與QR-Code (2)

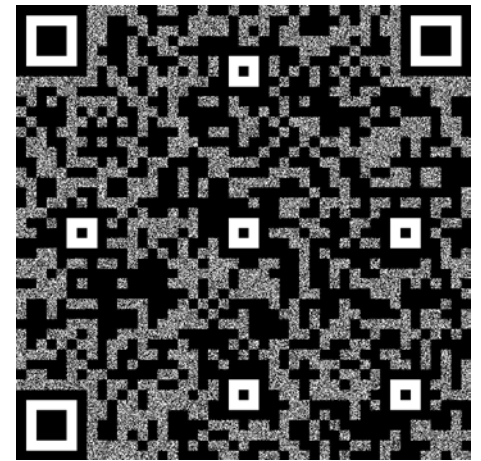
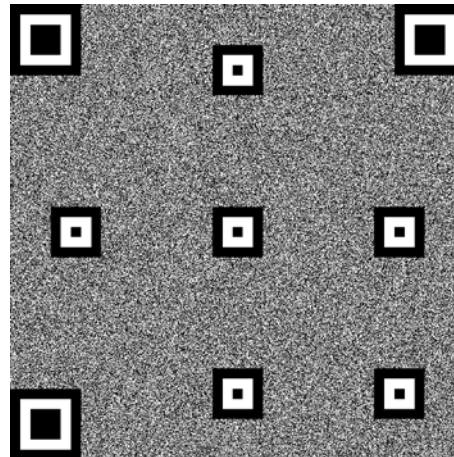
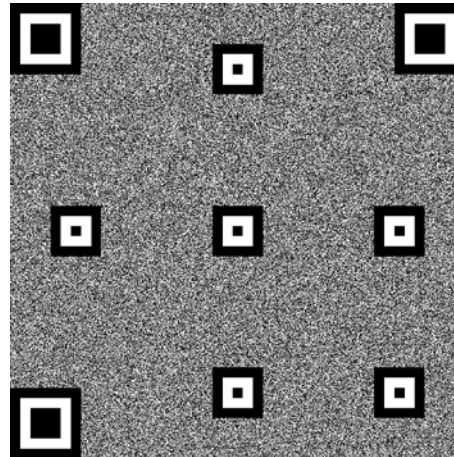

視覺密碼與QR-Code (3)



QR₁

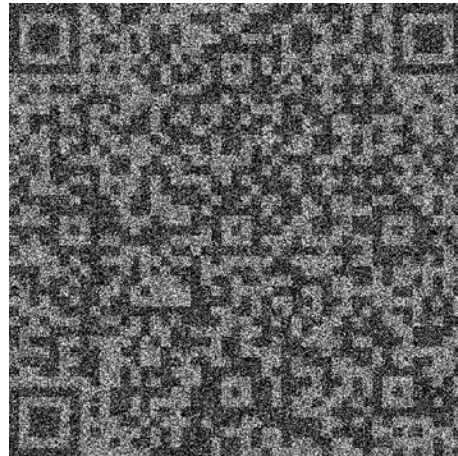

QR₃



QR₂

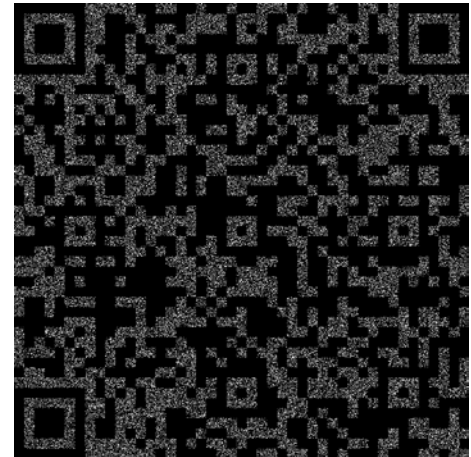
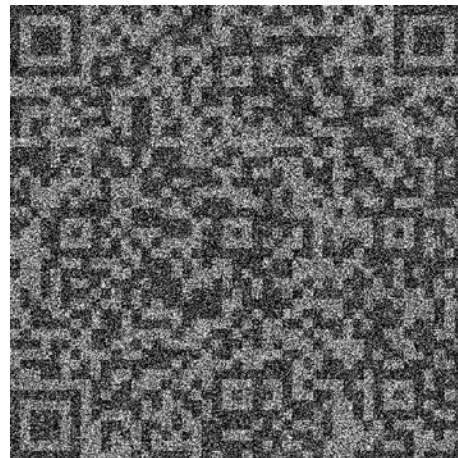

作業二

- 請利用視覺密碼的編碼技巧，實作出兩張投影片，當兩張投影片疊合後可看到一張機密影像。
 - 可手工繪製或利用電腦繪圖後再輸出
- 評分標準：
 - 疊合後的辨識程度
 - 單張投影片的安全性
- 額外加分：特別的疊合方式或其它創意
- 繳交方式：
 - 收件人：kchen@csie.org
 - 主旨：**[bcc13spr][hw][2] 學號 - 姓名**
- **Deadline: 2013年5月27日 23:59**



愛情樹

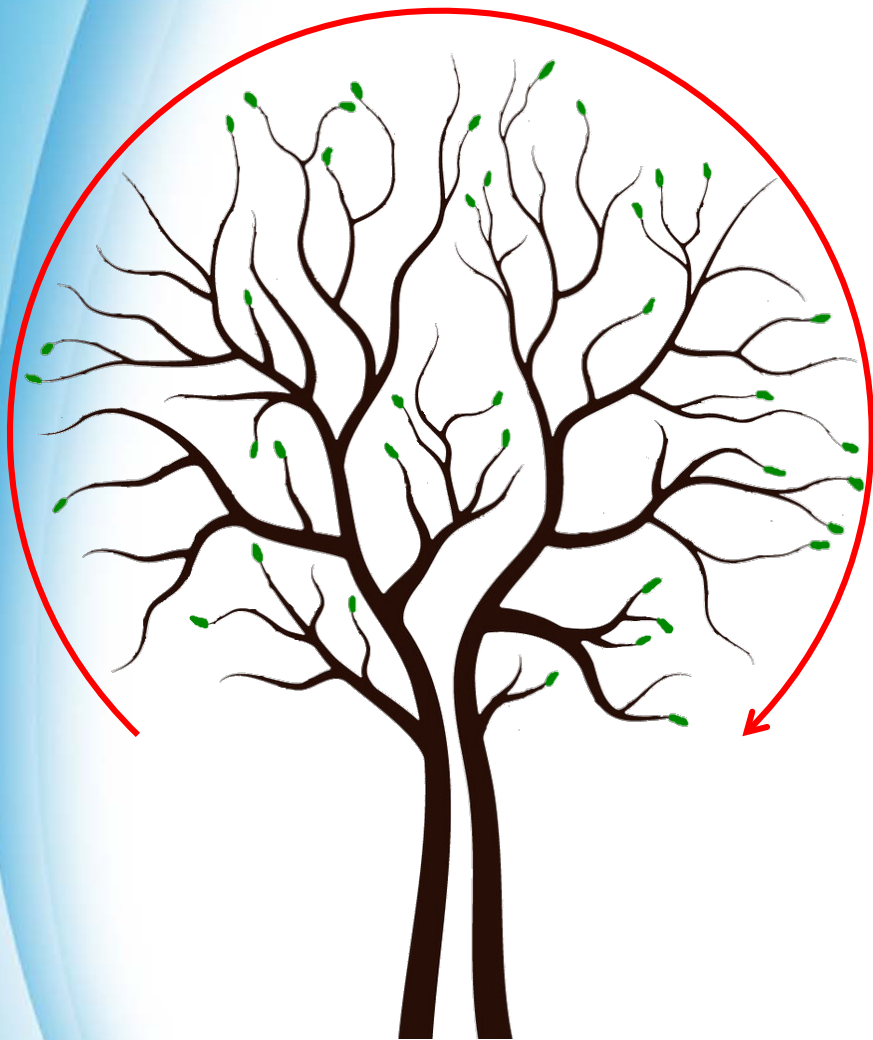

金鑰：
有葉為壹，無葉為零，
順時旋轉，ASCII。

01101001	i
01101100	l
01101111	o
01110110	v
01100101	e
01111001	y
01101111	o
01110101	u



Reference

- [1] M. Naor, A. Shamir, Visual Cryptography, *Advances in Cryptology: Eurpocrypt'94*, LNCS 950, 1-12, 1995.
- [2] C.C. Wu and L.H. Chen, A Study on Visual Cryptography, *Master thesis*, Institute of Computer and Information Science, National Chiao Tung University, Taiwan, R.O.C, 1998.
- [3] H.-C. Wu and C.-C. Chang, Sharing visual multi-secrets using circle shares, *Computer Standards & Interfaces*, 134(28), 123-135, 2005.
- [4] A. H. C. Wu, H. C. Wang and C. S. Tsai, Multiple image sharing based on colour visual cryptography, *The Imaging Science Journal*, 54(3), 164-177, 2006.
- [5] S. J. Shyu, S.-Y. Huang, Y.-K. Lee, R.-Z. Wang, K. Chen, Sharing multiple secrets in visual cryptography, *Pattern Recognition*, 40, 3633-3651, 2007
- [6] B. J. B. Feng, H. C. Wu, C. S. Tsai, Y. F. Chang and Y. P. Chu, Visual secret sharing for multiple secrets, *Pattern Recognition*, 41, 3572-3581, 2008.
- [7] J.Chen, T.S. Chen, H. C. Hsu, Y. H. Lin, Using multi-ringed shadow image of visual cryptography to hide more secret messages, *The Image Science Journal*, 57, 101-108, 2009
- [8] S. J. Shyu, K. Chen, Visual multiple secrets sharing by circle random grids, to appear in *SIAM Journal on Imaging Sciences*, 2010.

